

★ AS1024

Axial bearing washer

Schaeffler ID:
0000297500000

Axial bearing washers, suitable for AXK
and K811, to DIN 5405-3/ISO 303

★ Preferred product

Technical information

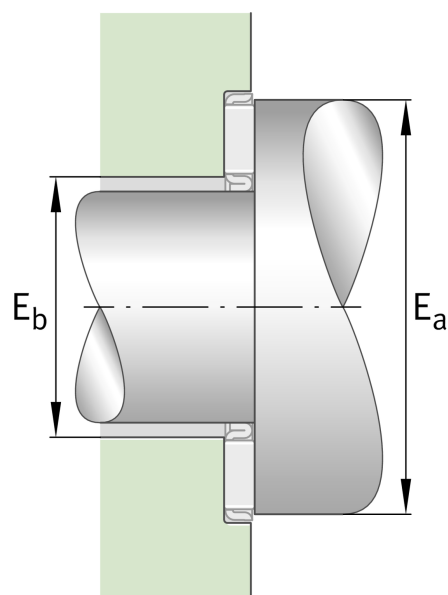
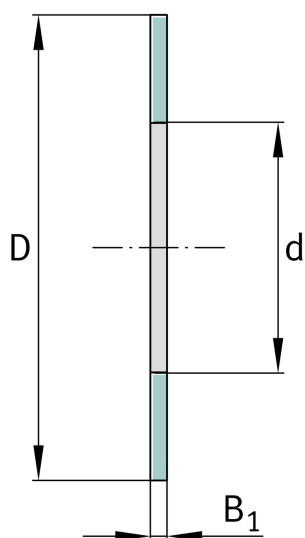

Main Dimensions & Performance Data

d	10 mm	Bore diameter bearing washer
D	24 mm	Outside diameter bearing washer
B ₁	1 mm	Height bearing washer
	2,7 g	Weight