

SAIL-M12GM8WR-3-5.0UGE

Weidmüller Interface GmbH & Co. KG

Klingenbergstraße 26

D-32758 Detmold

Germany

www.weidmueller.com



Sensor/actuator cables are used for wiring sensors and actuators and for transmitting data or power in various applications. The moulded cable offers connected and tested connection of the plug-in connector to the cable ex-works. The cables may be exposed to a wide range of conditions, such as humidity, dust, heat, cold, shock or vibration.

Our developers have focused specifically on this issue and designed a host of different M8 and M12 sensor-actuator cables so you are bound to find the solution you need for your application.

Is there something you have not managed to find or you feel needs explanation? Talk to us!

General ordering data

Version	Sensor/actuator line, Connecting line, M12 / M8, Number of poles : 3, 5 m, pin, straight - socket, 90°, Shielded: No, LED: No, Sheath material: PUR, Halogen: No
Order No.	1093150500
Type	SAIL-M12GM8WR-3-5.0UGE
GTIN (EAN)	4032248864997
Qty.	1 pc(s).

Creation date March 16, 2023 3:01:02 PM CET

Catalogue status 03.03.2023 / We reserve the right to make technical changes.

SAIL-M12GM8WR-3-5.0UGE

Weidmüller Interface GmbH & Co. KG

Klingenbergstraße 26

D-32758 Detmold

Germany

www.weidmueller.com

Technical data

Dimensions and weights

Net weight 128 g

Temperatures

Operating temperature, min. -25 °C Operating temperature, max. 80 °C

Technical specifications for cable

Acceleration	5 m/s ²	Bending cycles	5 Mio
Bending cycles at torsion	> 5 Mio.	Bending radius, min., moving	10 x cable diameter
Bending radius, min., stationary	5 x cable diameter	Cable length	5 m
Colour coding	brown, blue, black	Configurable cable length	No
Core cross-section	0.25 mm ²	Core in accordance with UL AWM style	10493 (80 °C / 300 V)
Halogen	No	Hydrolysis and microbe resistant	Yes
Insulation	PP	Irradiation crosslinked	No
Length of torsion	1 m	Number of poles	3
Outer cladding in accordance with UL AWM style	20549 (80 °C / 300 V)	Outside diameter	4.1 mm ± 0.2 mm
Resistance to oils	in accordance with IEC 60811:404	Resistance to spread of flame	In accordance with UL1581 UL / CUL FT2, in accordance with IEC 60332-2-2
Resistant to welding beads	No	Sheath material	PUR
Sheathing colour	yellow	Shielded	No
Speed	5 m/s	Suitable for cable carriers	Yes
Temperature range, moving	-25...80 °C	Temperature range, stationary	-40...80 °C
Torsion resistance	360 °/m	Welding spark resistance	No

General technical data

Coding	M12 = A, M8 = none	Connection thread	M12 / M8
Contact surface	Gold-plated	Housing main material	PUR
Insulation strength	10 ⁸ Ω	LED	No
Plugging cycles	≥ 100	Pollution severity	3
Protection degree	IP65 (in plugged condition)	Rated current	4 A
Rated voltage	60 V	Temperature range of housing	-40 ... +85 °C
Threaded ring material	Brass, nickel-plated	Tightening torque	M8: 0.5 - 0.6 Nm
Version	pin, straight - socket, 90°	jumpered	No

Electrical properties

Insulation strength 10⁸ Ω Rated voltage 60 V

General standards

Connector standard IEC 61076-2-101, IEC 61076-2-104

Standards

Connector standard IEC 61076-2-101, IEC 61076-2-104

Creation date March 16, 2023 3:01:02 PM CET

Catalogue status 03.03.2023 / We reserve the right to make technical changes.

SAIL-M12GM8WR-3-5.0UGE

Weidmüller Interface GmbH & Co. KG

Klingenbergstraße 26

D-32758 Detmold

Germany

www.weidmueller.com

Technical data

Classifications

ETIM 6.0	EC001855	ETIM 7.0	EC001855
ETIM 8.0	EC001855	ECLASS 9.0	27-06-03-11
ECLASS 9.1	27-06-03-11	ECLASS 10.0	27-06-03-11
ECLASS 11.0	27-06-03-11	ECLASS 12.0	27-06-03-11

Environmental Product Compliance

REACH SVHC	Lead 7439-92-1
SCIP	1c533b66-fcff-4da5-b89f-fd55fbf5cb55

Approvals

Approvals



ROHS Conform

Downloads

Engineering Data	WSCAD
Product Change Notification	DE - Technische Änderung zu M12 Gewinding mit 6-Kant EN - Technical change to M12 nut with additional hexagonal mounting
Catalogues	Catalogues in PDF-format
Brochures	FL FIELDWIRING EN

SAIL-M12GM8WR-3-5.0UGE

Weidmüller Interface GmbH & Co. KG
 Klingenbergstraße 26
 D-32758 Detmold
 Germany

www.weidmueller.com

Drawings

Dimensioned drawing



Male, straight

Pole scheme



Dimensioned drawing

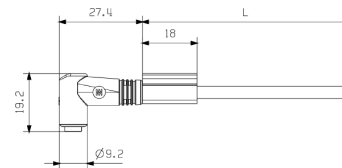

Angled socket

Pole scheme

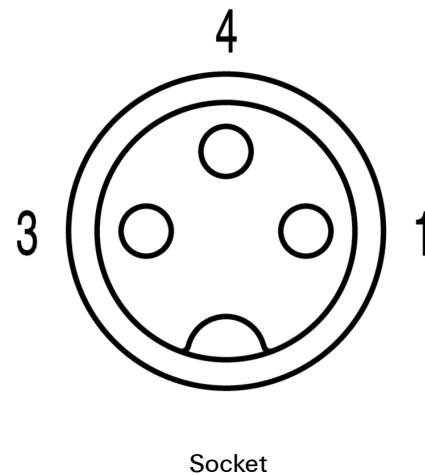

Wiring diagram



The ideal tool: Screwty® with torque function



Light, securely screwed-in round plug-in connectors. Screwty set DM / VPE: 1 / Order No.: 1920000000 Adapters: M12, M12 F, M8, M8 F