

LX 15.00/03/90 4.5SN BK BX

Weidmüller Interface GmbH & Co. KG

Klingenbergstraße 26

D-32758 Detmold

Germany

www.weidmueller.com

Product image

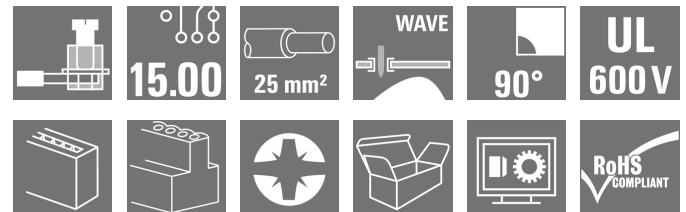

High-performance PCB terminal with proven clamping yoke connection at 15.00 mm pitch, conductor outlet direction in 90° design. Version and test point.

General ordering data

Version	Printed circuit board terminals, 15.00 mm, Number of poles: 3, 90°, Solder pin length (l): 4.5 mm, tinned, black, Clamping yoke connection, Clamping range, max. : 25 mm ² , Box
Order No.	1174720000
Type	LX 15.00/03/90 4.5SN BK BX
GTIN (EAN)	4032248967346
Qty.	20 pc(s).
Product data	IEC: 1000 V / 101 A / 1.5 - 25 mm ² UL: 600 V / 85 A / AWG 16 - AWG 4
Packaging	Box

Creation date March 1, 2023 12:03:44 PM CET

LX 15.00/03/90 4.5SN BK BX**Weidmüller Interface GmbH & Co. KG**

Klingenbergstraße 26

D-32758 Detmold

Germany

www.weidmueller.com

Technical data**Dimensions and weights**

Depth	29.1 mm	Depth (inches)	1.146 inch
Height	41.5 mm	Height (inches)	1.634 inch
Height of lowest version	37 mm	Width	43 mm
Width (inches)	1.693 inch	Net weight	51.1 g

Temperatures

Operating temperature, min.	-50 °C	Operating temperature, max.	120 °C
-----------------------------	--------	-----------------------------	--------

System parameters

Product family	OMNIMATE Power - series LX	Wire connection method	Clamping yoke connection
Mounting onto the PCB	THT solder connection	Conductor outlet direction	90°
Pitch in mm (P)	15 mm	Pitch in inches (P)	0.591 inch
Number of poles	3	Pin series quantity	1
Fitted by customer	No	Number of rows	1
Max. adjacent poles per row	10	Solder pin length (l)	4.5 mm
Solder pin dimensions	1.2 x 1.2 mm	Solder eyelet hole diameter (D)	1.6 mm
Solder eyelet hole diameter tolerance (D)+	0,1 mm	Number of solder pins per pole	4
Screwdriver blade	1.0 x 5.5	Screwdriver blade standard	DIN 5264
Tightening torque, min.	2.4 Nm	Tightening torque, max.	4 Nm
Clamping screw	M 5	Stripping length	16 mm
L1 in mm	30 mm	L1 in inches	1.181 inch
Touch-safe protection acc. to DIN VDE 0470	IP 10	Touch-safe protection acc. to DIN VDE 57 106	Safe from finger touch
Protection degree	IP20	Volume resistance	0.50 mΩ

Material data

Insulating material	Wemid (PA)	Colour	black
Colour chart (similar)	RAL 9011	Insulating material group	I
Comparative Tracking Index (CTI)	≥ 600	UL 94 flammability rating	V-0
Contact material	E-Cu	Contact surface	tinned
Layer structure of solder connection	1.5...3 µm Ni / 4...6 µm Sn matt	Storage temperature, min.	-40 °C
Storage temperature, max.	70 °C	Operating temperature, min.	-50 °C
Operating temperature, max.	120 °C	Temperature range, installation, min.	-25 °C
Temperature range, installation, max.	120 °C		

Conductors suitable for connection

Clamping range, min.	1.31 mm ²
Clamping range, max.	25 mm ²
Wire connection cross section AWG, min.	AWG 16
Wire connection cross section AWG, max.	AWG 4
Solid, min. H05(07) V-U	1.5 mm ²
Solid, max. H05(07) V-U	16 mm ²
Stranded, min. H07V-R	6 mm ²
Stranded, max. H07V-R	25 mm ²
Flexible, min. H05(07) V-K	1.5 mm ²
Flexible, max. H05(07) V-K	25 mm ²
w. plastic collar ferrule, DIN 46228 pt 4,	1.5 mm ² min.

Creation date March 1, 2023 12:03:44 PM CET

LX 15.00/03/90 4.5SN BK BX

Weidmüller Interface GmbH & Co. KG
 Klingenbergstraße 26
 D-32758 Detmold
 Germany

www.weidmueller.com

Technical data

w. plastic collar ferrule, DIN 46228 pt 4, 16 mm ² max.				
w. wire end ferrule, DIN 46228 pt 1, min.	1.5 mm ²			
w. wire end ferrule, DIN 46228 pt 1, max.	16 mm ²			
Plug gauge in accordance with EN 60999 a x b; ø	6.9 mm x 6.9 mm			
Clampable conductor	Cross-section for conductor connection	Type	fine-wired	
		nominal	4 mm ²	
	wire end ferrule	Stripping length	nominal	15 mm
		Recommended wire-end ferrule	H4.0/15	
	Cross-section for conductor connection	Type	fine-wired	
		nominal	6 mm ²	
	wire end ferrule	Stripping length	nominal	15 mm
		Recommended wire-end ferrule	H6.0/15	
	Cross-section for conductor connection	Type	fine-wired	
		nominal	10 mm ²	
	wire end ferrule	Stripping length	nominal	15 mm
		Recommended wire-end ferrule	H10.0/15	
Cross-section for conductor connection	Type	fine-wired		
	nominal	16 mm ²		
wire end ferrule	Stripping length	nominal	15 mm	
	Recommended wire-end ferrule	H16.0/15		

Reference text Length of ferrules is to be chosen depending on the product and the rated voltage.. The outside diameter of the plastic collar should not be larger than the pitch (P)

Rated data acc. to IEC

tested acc. to standard	IEC 60664-1, IEC 61984	Rated current, min. number of poles (Tu=20°C)	101 A
Rated current, max. number of poles (Tu=20°C)	101 A	Rated current, min. number of poles (Tu=40°C)	101 A
Rated current, max. number of poles (Tu=40°C)	101 A	Rated voltage for surge voltage class / pollution degree II/2	1,000 V
Rated voltage for surge voltage class / pollution degree III/2	1,000 V	Rated voltage for surge voltage class / pollution degree III/3	1,000 V
Rated impulse voltage for surge voltage class/ pollution degree II/2	6 kV	Rated impulse voltage for surge voltage class/ pollution degree III/2	8 kV
Rated impulse voltage for surge voltage class/ contamination degree III/3	8 kV	Short-time withstand current resistance	3 x 1s mit 1000 A

Rated data acc. to CSA

Institute (CSA)		Certificate No. (CSA)	200039-1198743
Rated voltage (Use group B / CSA)	600 V	Rated voltage (Use group C / CSA)	600 V
Rated voltage (Use group D / CSA)	600 V	Rated current (Use group B / CSA)	85 A
Rated current (Use group C / CSA)	85 A	Rated current (Use group D / CSA)	5 A
Wire cross-section, AWG, min.	AWG 16	Wire cross-section, AWG, max.	AWG 4
Reference to approval values	Specifications are maximum values, details - see approval certificate.		

Creation date March 1, 2023 12:03:44 PM CET

LX 15.00/03/90 4.5SN BK BX

Weidmüller Interface GmbH & Co. KG
 Klingenbergstraße 26
 D-32758 Detmold
 Germany

www.weidmueller.com

Technical data

Rated data acc. to UL 1059

Institute (UR)		Certificate No. (UR)	E60693
Rated voltage (Use group B / UL 1059)	600 V	Rated voltage (Use group C / UL 1059)	600 V
Rated voltage (Use group D / UL 1059)	600 V	Rated current (Use group B / UL 1059)	85 A
Rated current (Use group C / UL 1059)	85 A	Rated current (Use group D / UL 1059)	5 A
Wire cross-section, AWG, min.	AWG 16	Wire cross-section, AWG, max.	AWG 4
Reference to approval values	Specifications are maximum values, details - see approval certificate.		

Packing

Packaging	Box	VPE length	159 mm
VPE width	93 mm	VPE height	83 mm

Type tests

Test: Durability of markings	Standard	DIN EN 61984 section 7.3.2 / 09.02 taking pattern from DIN EN 60068-2-70 / 07.96	
	Test	mark of origin, type identification, pitch, approval marking CSA, approval marking UL, type of material, durability	
	Evaluation	available	
Test: Clampable cross section	Standard	DIN EN 60999 section 6 and 8.1 / 04.94, DIN EN 60947-1 section 8.2.4.5.1 / 12.99	
	Conductor type	Type of conductor and conductor cross-section	solid 1.5 mm ²
		Type of conductor and conductor cross-section	stranded 1.5 mm ²
		Type of conductor and conductor cross-section	solid 16 mm ²
Test for damage to and accidental loosening of conductors	Standard	DIN EN 60999 section 8.4 / 04.94	

Classifications

ETIM 6.0	EC002643	ETIM 7.0	EC002643
ETIM 8.0	EC002643	ECLASS 9.0	27-44-04-01
ECLASS 9.1	27-44-04-01	ECLASS 10.0	27-44-04-01
ECLASS 11.0	27-46-01-01	ECLASS 12.0	27-46-01-01

LX 15.00/03/90 4.5SN BK BX**Weidmüller Interface GmbH & Co. KG**

Klingenbergstraße 26

D-32758 Detmold

Germany

www.weidmueller.com

Technical data**Important note**

IPC conformity	Conformity: The products are developed, manufactured and delivered according international recognized standards and norms and comply with the assured properties in the data sheet resp. fulfill decorative properties in accordance with IPC-A-610 "Class 2". Further claims on the products can be evaluated on request.
Notes	<ul style="list-style-type: none"> • Additional variants on request • Rated current related to rated cross-section & min. No. of poles. • Wire end ferrule without plastic collar to DIN 46228/1 • Wire end ferrule with plastic collar to DIN 46228/4 • P on drawing = pitch • Rated data refer only to the component itself. Clearance and creepage distances to other components are to be designed in accordance with the relevant application standards. • The test point can only be used as potential-pickup point. • Long term storage of the product with average temperature of 50 °C and average humidity 70%, 36 months

Approvals

Approvals



ROHS	Conform
UL File Number Search	UL Website
Certificate No. (UR)	E60693

Downloads

Approval/Certificate/Document of Conformity	Declaration of the Manufacturer
Engineering Data	CAD data – STEP
Engineering Data	WSCAD
Product Change Notification	20220201 Visual change OMNIMATE® Power PCB terminal blocks and connectors 20220201 Visuelle Änderung OMNIMATE® Power Leiterplattenklemmen und -steckverbinder
User Documentation	QR-Code product handling video
Catalogues	Catalogues in PDF-format
Brochures	FL DRIVES EN MB DEVICE MANUF. EN FL DRIVES DE FL APPL. INVERTER EN FL_BASE_STATION_EN FL ELEVATOR EN FL POWER SUPPLY EN FL 72H SAMPLE SER EN PO OMNIMATE EN PO OMNIMATE EN

Creation date March 1, 2023 12:03:44 PM CET

Catalogue status 18.02.2023 / We reserve the right to make technical changes.

5

LX 15.00/03/90 4.5SN BK BX

Weidmüller Interface GmbH & Co. KG
 Klingenbergstraße 26
 D-32758 Detmold
 Germany

www.weidmueller.com

Drawings

Dimensional drawing

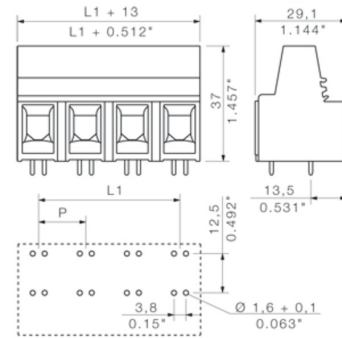

Graph

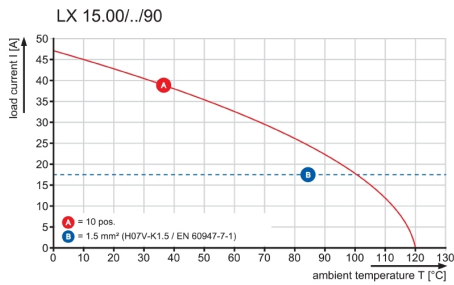

Graph

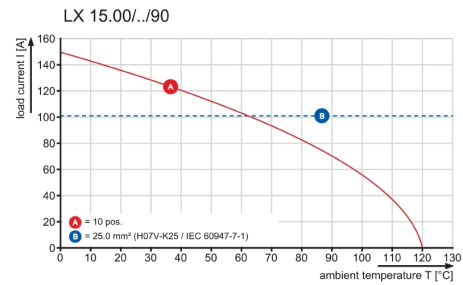

The reproduction, distribution and utilization of this document as well as the communication of its contents to others without explicit authorization is prohibited. Offenders will be held liable for the payment of damages. Weidmüller exclusively reserves the right to file for patents, utility models or designs.

© Weidmüller Interface GmbH & Co. KG

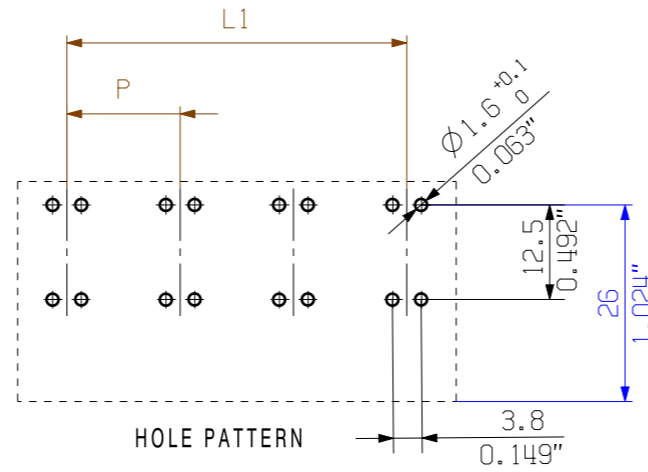

PS 2.0
Order NO. 031000 0000

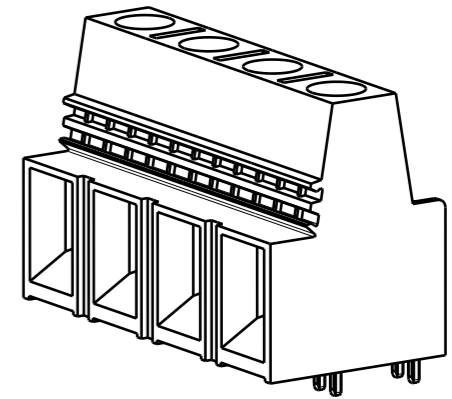

P = Pitch
n = No. of Poles
l = Pin length
Shown: LX15.00/04/90/...

PIN LENGTH l	TOLERANCE	n	L1 [mm]	L1 [Inch]
6,5	0/-0,35	10	135,00	5,315
4,5	0/-0,35	9	120,00	4,724
		8	105,00	4,134
		7	90,00	3,543
		6	75,00	2,953
		5	60,00	2,362
		4	45,00	1,772
		3	30,00	1,181
		2	15,00	0,591

For the mounting of PCBs, it should be noted that the rated data relates only to the PCB components alone. The necessary creepage and clearance paths must be observed in connection with the respective applicant in accordance to IEC 60664-1 (VDE 0110). The current-carrying capacity and pitch tolerance is to be determined according to DIN IEC 60326-3 very fine.

Weidmüller PCB components are tested to the IEC 60947-7-4 standard, and are valid for its field of application. Provided that the components are used to the intended purpose, all requirements with respect to the occurring of electrical, mechanical, thermic and corrosive stress will be satisfied.

GENERAL TOLERANCE:
DIN ISO 2768-m

	EC00000683	00	Prim PLM Part No.: 009292	Prim ERP Part No.: 1226480000
	First Issue Date 14.05.2018	Max. nos.		
	Modification			
	Drawn	Date	Name	LX.. 15.00/./90... LEITERPLATTENKLEMME PCB TERMINAL
	Responsible			
	Approved	Date	Name	
Scale: 1/1	Size: A3	Drawings Assembly	Product file: 7234 LX 15.00	

29942 29
 Drawing no. Issue no.
 Sheet 01 of 04 sheets

Recommended wave soldering profiles

Weidmüller Interface GmbH & Co. KG
 Klingenbergstraße 16
 D-32758 Detmold
 Germany
 Fon: +49 5231 14-0
 Fax: +49 5231 14-292083
 www.weidmueller.com

Single Wave:



Double Wave:



Wave soldering profiles

Wired connection elements should be processed in accordance with the DIN EN 61760-1 standard. We have included two recommendations for practical wave soldering profiles, with which Weidmüller PCB terminals and connectors are qualified.

When choosing a suitable profile for your application, the following factors also need to be considered:

- PCB thickness
- Proportion of Cu in the layers
- Single/double-sided assembly
- Product range
- Heating and cooling rates

The single and double wave profiles each indicate the recommended operating range, including the maximum soldering temperature of 260°C. In practice, the maximum soldering temperature is quite often well below the above maximum profile.