

## LM 5.00/14/135 3.5SN OR BX

**Weidmüller Interface GmbH & Co. KG**

Klingenbergstraße 26

D-32758 Detmold

Germany

www.weidmueller.com

### Product image

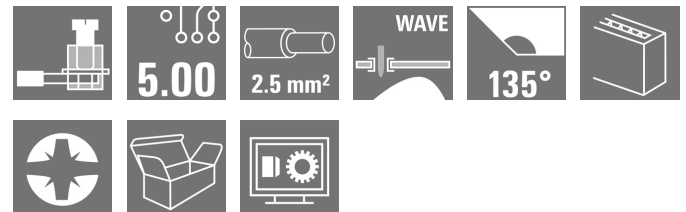
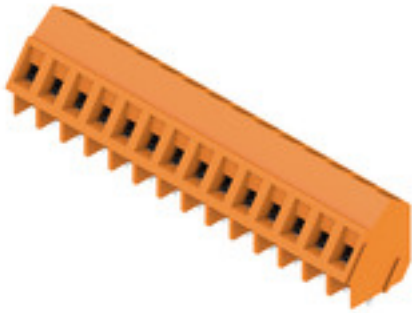

PCB terminal with proven clamping yoke connection at 5.00 and 5.08 mm pitch. Conductor outlet direction 90°, 135° and 180°. Suitable for conductor cross-sections up to 2.5 mm<sup>2</sup>.

### General ordering data

Version	Printed circuit board terminals, 5.00 mm, Number of poles: 14, 135°, Solder pin length (l): 3.5 mm, tinned, orange, Clamping yoke connection, Clamping range, max. : 2.5 mm <sup>2</sup> , Box
Order No.	<a href="#">1233920000</a>
Type	LM 5.00/14/135 3.5SN OR BX
GTIN (EAN)	4050118017748
Qty.	50 pc(s).
Product data	IEC: 630 V / 17.5 A / 0.2 - 2.5 mm <sup>2</sup> UL: 300 V / 15 A / AWG 24 - AWG 14
Packaging	Box

Creation date March 7, 2023 6:33:23 PM CET

## LM 5.00/14/135 3.5SN OR BX

Weidmüller Interface GmbH &amp; Co. KG

Klingenbergstraße 26

D-32758 Detmold

Germany

www.weidmueller.com

## Technical data

## Dimensions and weights

Depth	13.9 mm	Depth (inches)	0.547 inch
Height	19 mm	Height (inches)	0.748 inch
Height of lowest version	15.5 mm	Width	70 mm
Width (inches)	2.756 inch	Net weight	16.8 g

## Temperatures

Operating temperature, min.	-50 °C	Operating temperature, max.	120 °C
-----------------------------	--------	-----------------------------	--------

## System parameters

Product family	OMNIMATE Signal - series LM	Wire connection method	Clamping yoke connection
Mounting onto the PCB	THT solder connection	Conductor outlet direction	135°
Pitch in mm (P)	5 mm	Pitch in inches (P)	0.197 inch
Number of poles	14	Pin series quantity	1
Fitted by customer	Yes	Number of rows	1
Max. adjacent poles per row	24	Solder pin length (l)	3.5 mm
Solder pin dimensions	0.95 x 0.8 mm	Solder eyelet hole diameter (D)	1.3 mm
Solder eyelet hole diameter tolerance (D)+	0,1 mm	Number of solder pins per pole	1
Screwdriver blade	0.6 x 3.5	Screwdriver blade standard	DIN 5264
Tightening torque, min.	0.4 Nm	Tightening torque, max.	0.5 Nm
Clamping screw	M 2.5	Stripping length	6 mm
L1 in mm	65 mm	L1 in inches	2.559 inch
Touch-safe protection acc. to DIN VDE 0470	IP 20	Touch-safe protection acc. to DIN VDE 57 106	Safe from finger touch
Protection degree	IP20	Volume resistance	1.20 mΩ

## Material data

Insulating material	Wemid (PA)	Colour	orange
Colour chart (similar)	RAL 2000	Insulating material group	I
Comparative Tracking Index (CTI)	≥ 600	Insulation strength	≥ 10 <sup>8</sup> Ω
UL 94 flammability rating	V-0	Contact material	Copper alloy
Contact surface	tinned	Coating	1-3 μm Ni, 4-6 μm SN
Tinning type	matt	Layer structure of solder connection	1...3 μm Ni / 4...6 μm Sn matt
Storage temperature, min.	-40 °C	Storage temperature, max.	70 °C
Operating temperature, min.	-50 °C	Operating temperature, max.	120 °C
Temperature range, installation, min.	-25 °C	Temperature range, installation, max.	120 °C

## Conductors suitable for connection

Clamping range, min.	0.2 mm <sup>2</sup>
Clamping range, max.	2.5 mm <sup>2</sup>
Wire connection cross section AWG, min.	AWG 24
Wire connection cross section AWG, max.	AWG 14
Solid, min. H05(07) V-U	0.2 mm <sup>2</sup>
Solid, max. H05(07) V-U	2.5 mm <sup>2</sup>
Flexible, min. H05(07) V-K	0.2 mm <sup>2</sup>
Flexible, max. H05(07) V-K	2.5 mm <sup>2</sup>
w. plastic collar ferrule, DIN 46228 pt 4,	0.25 mm <sup>2</sup> min.

Creation date March 7, 2023 6:33:23 PM CET

## LM 5.00/14/135 3.5SN OR BX

**Weidmüller Interface GmbH & Co. KG**

Klingenbergstraße 26

D-32758 Detmold

Germany

www.weidmueller.com

## Technical data

w. plastic collar ferrule, DIN 46228 pt 4, 1.5 mm<sup>2</sup>  
max.

w. wire end ferrule, DIN 46228 pt 1, 0.25 mm<sup>2</sup>  
min.

w. wire end ferrule, DIN 46228 pt 1, 1.5 mm<sup>2</sup>  
max.

Plug gauge in accordance with EN 60999 a x b; ø 2.4 mm x 1.5 mm; 1.9mm

Clampable conductor	Cross-section for conductor connection	Type	fine-wired
		nominal	0.5 mm <sup>2</sup>
wire end ferrule	Stripping length	nominal	8 mm
		Recommended wire-end ferrule	<a href="#">H0.5/12 OR</a>
	Stripping length	nominal	6 mm
		Recommended wire-end ferrule	<a href="#">H0.5/6</a>
Cross-section for conductor connection	Type	fine-wired	
	nominal	0.75 mm <sup>2</sup>	
wire end ferrule	Stripping length	nominal	8 mm
		Recommended wire-end ferrule	<a href="#">H0.75/12 W</a>
	Stripping length	nominal	6 mm
		Recommended wire-end ferrule	<a href="#">H0.75/6</a>
Cross-section for conductor connection	Type	fine-wired	
	nominal	1 mm <sup>2</sup>	
wire end ferrule	Stripping length	nominal	8 mm
		Recommended wire-end ferrule	<a href="#">H1.0/12 GE</a>
	Stripping length	nominal	6 mm
		Recommended wire-end ferrule	<a href="#">H1.0/6</a>
Cross-section for conductor connection	Type	fine-wired	
	nominal	0.25 mm <sup>2</sup>	
wire end ferrule	Stripping length	nominal	8 mm
		Recommended wire-end ferrule	<a href="#">H0.25/10 HBL</a>
	Stripping length	nominal	5 mm
		Recommended wire-end ferrule	<a href="#">H0.25/5</a>
Cross-section for conductor connection	Type	fine-wired	
	nominal	0.34 mm <sup>2</sup>	
wire end ferrule	Stripping length	nominal	8 mm
	Recommended wire-end ferrule	<a href="#">H0.34/10 TK</a>	

Reference text Length of ferrules is to be chosen depending on the product and the rated voltage.. The outside diameter of the plastic collar should not be larger than the pitch (P)

## LM 5.00/14/135 3.5SN OR BX

Weidmüller Interface GmbH &amp; Co. KG

Klingenbergstraße 26

D-32758 Detmold

Germany

www.weidmueller.com

## Technical data

## Rated data acc. to IEC

tested acc. to standard	IEC 60664-1, IEC 61984	Rated current, min. number of poles (Tu=20°C)	17.5 A
Rated current, max. number of poles (Tu=20°C)	16 A	Rated current, min. number of poles (Tu=40°C)	17.5 A
Rated current, max. number of poles (Tu=40°C)	14.2 A	Rated voltage for surge voltage class / pollution degree II/2	630 V
Rated voltage for surge voltage class / pollution degree III/2	320 V	Rated voltage for surge voltage class / pollution degree III/3	250 V
Rated impulse voltage for surge voltage class/ pollution degree II/2	4 kV	Rated impulse voltage for surge voltage class/ pollution degree III/2	4 kV
Rated impulse voltage for surge voltage class/ contamination degree III/3	4 kV	Short-time withstand current resistance	3 x 1s with 120 A

## Rated data acc. to CSA

Institute (CSA)		Certificate No. (CSA)	200039-1815154
Rated voltage (Use group B / CSA)	300 V	Rated voltage (Use group D / CSA)	300 V
Rated current (Use group B / CSA)	18 A	Rated current (Use group D / CSA)	10 A
Wire cross-section, AWG, min.	AWG 24	Wire cross-section, AWG, max.	AWG 14
Reference to approval values	Specifications are maximum values, details - see approval certificate.		

## Rated data acc. to UL 1059

Institute (cURus)		Certificate No. (cURus)	E60693
Rated voltage (Use group B / UL 1059)	300 V	Rated voltage (Use group D / UL 1059)	300 V
Rated current (Use group B / UL 1059)	15 A	Rated current (Use group D / UL 1059)	10 A
Wire cross-section, AWG, min.	AWG 24	Wire cross-section, AWG, max.	AWG 14
Reference to approval values	Specifications are maximum values, details - see approval certificate.		

## Packing

Packaging	Box	VPE length	275 mm
VPE width	150 mm	VPE height	105 mm

## Type tests

Test: Durability of markings	Test	mark of origin, type identification, pitch, type of material, approval marking UL, approval marking CSA, durability
	Evaluation	available

**LM 5.00/14/135 3.5SN OR BX**

**Weidmüller Interface GmbH & Co. KG**  
 Klingenbergstraße 26  
 D-32758 Detmold  
 Germany

www.weidmueller.com

**Technical data**

Test: Clampable cross section	Standard	DIN EN 60999-1 section 7 and 9.1 / 12.00, DIN EN 60947-1 section 8.2.4.5.1 / 12.02	
	Conductor type	Type of conductor and conductor cross-section	solid 0.2 mm <sup>2</sup>
		Type of conductor and conductor cross-section	stranded 0.2 mm <sup>2</sup>
		Type of conductor and conductor cross-section	stranded 1.5 mm <sup>2</sup>
		Type of conductor and conductor cross-section	solid 2.5 mm <sup>2</sup>
		Type of conductor and conductor cross-section	AWG 24/1
		Type of conductor and conductor cross-section	AWG 24/19
		Type of conductor and conductor cross-section	AWG 14/1
		Type of conductor and conductor cross-section	AWG 14/19
Evaluation	passed		
Test for damage to and accidental loosening of conductors	Standard	DIN EN 60999-1 section 9.4 / 12.00	
	Requirement	0.2 kg	
	Conductor type	Type of conductor and conductor cross-section	stranded 0.25 mm <sup>2</sup>
		Type of conductor and conductor cross-section	AWG 24/1
		Type of conductor and conductor cross-section	AWG 24/19
	Evaluation	passed	
	Requirement	0.3 kg	
	Conductor type	Type of conductor and conductor cross-section	solid 0.5 mm <sup>2</sup>
	Evaluation	passed	
	Requirement	0.4 kg	
	Conductor type	Type of conductor and conductor cross-section	stranded 1.5 mm <sup>2</sup>
	Evaluation	passed	
	Requirement	0.7 kg	
	Conductor type	Type of conductor and conductor cross-section	solid 2.5 mm <sup>2</sup>
		Type of conductor and conductor cross-section	AWG 14/1
Type of conductor and conductor cross-section		AWG 14/19	
Evaluation	passed		

## LM 5.00/14/135 3.5SN OR BX

Weidmüller Interface GmbH &amp; Co. KG

Klingenbergstraße 26

D-32758 Detmold

Germany

www.weidmueller.com

## Technical data

Pull-out test	Standard	DIN EN 60999-1 section 9.5 / 12.00		
	Requirement	≥10 N		
	Conductor type	Type of conductor and conductor cross-section	stranded 0.25 mm <sup>2</sup>	
		Type of conductor and conductor cross-section	AWG 24/1	
		Type of conductor and conductor cross-section	AWG 24/19	
	Evaluation	passed		
	Requirement	≥20 N		
	Requirement	≥40 N		
	Conductor type	Type of conductor and conductor cross-section	H07V-K1.5	
		Evaluation	passed	
	Requirement	≥50 N		
	Conductor type	Type of conductor and conductor cross-section	H07V-U2.5	
		Type of conductor and conductor cross-section	AWG 14/1	
		Type of conductor and conductor cross-section	AWG 14/19	
	Evaluation	passed		

## Classifications

ETIM 6.0	EC002643	ETIM 7.0	EC002643
ETIM 8.0	EC002643	ECLASS 9.0	27-44-04-01
ECLASS 9.1	27-44-04-01	ECLASS 10.0	27-44-04-01
ECLASS 11.0	27-46-01-01	ECLASS 12.0	27-46-01-01

## Important note

IPC conformity	Conformity: The products are developed, manufactured and delivered according international recognized standards and norms and comply with the assured properties in the data sheet resp. fulfill decorative properties in accordance with IPC-A-610 "Class 2". Further claims on the products can be evaluated on request.
Notes	<ul style="list-style-type: none"> <li>• Rated current related to rated cross-section &amp; min. No. of poles.</li> <li>• Wire end ferrule without plastic collar to DIN 46228/1</li> <li>• Wire end ferrule with plastic collar to DIN 46228/4</li> <li>• P on drawing = pitch</li> <li>• Rated data refer only to the component itself. Clearance and creepage distances to other components are to be designed in accordance with the relevant application standards.</li> <li>• Long term storage of the product with average temperature of 50 °C and average humidity 70%, 36 months</li> </ul>

## LM 5.00/14/135 3.5SN OR BX

**Weidmüller Interface GmbH & Co. KG**  
Klingenbergstraße 26  
D-32758 Detmold  
Germany

www.weidmueller.com

## Technical data

### Approvals

Approvals



UL File Number Search	UL Website
Certificate No. (cURus)	E60693

### Downloads

Approval/Certificate/Document of Conformity	<a href="#">Declaration of the Manufacturer</a>
Engineering Data	<a href="#">CAD data – STEP</a>
Engineering Data	<a href="#">WSCAD</a>
Catalogues	<a href="#">Catalogues in PDF-format</a>
Brochures	<a href="#">FL DRIVES EN</a> <a href="#">FL ANALO.SIGN.CONV. EN</a> <a href="#">MB DEVICE MANUF. EN</a> <a href="#">FL DRIVES DE</a> <a href="#">FL BUILDING SAFETY EN</a> <a href="#">FL APPL LED LIGHTING EN</a> <a href="#">FLIndustr.CONTROLS EN</a> <a href="#">FL MACHINE SAFETY EN</a> <a href="#">FL HEATING ELECTR EN</a> <a href="#">FL APPL INVERTER EN</a> <a href="#">FL_BASE_STATION EN</a> <a href="#">FL ELEVATOR EN</a> <a href="#">FL POWER SUPPLY EN</a> <a href="#">FL 72H SAMPLE SER EN</a> <a href="#">PO OMNIMATE EN</a> <a href="#">PO OMNIMATE EN</a>

**LM 5.00/14/135 3.5SN OR BX**

**Weidmüller Interface GmbH & Co. KG**  
 Klingenbergstraße 26  
 D-32758 Detmold  
 Germany

www.weidmueller.com

**Drawings**

**Product image**

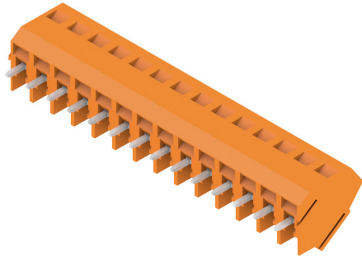

**Dimensional drawing**

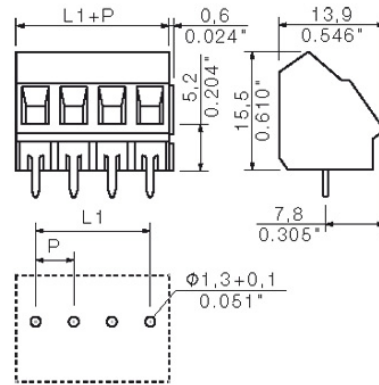

**Graph**

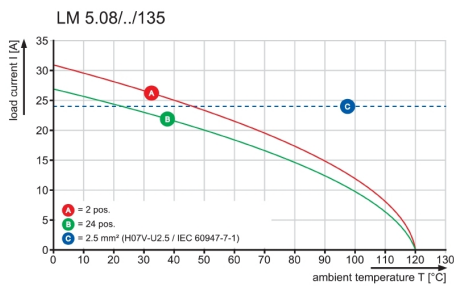

Derating curve valid for 5.00 & 5.08 pitch



MASSE OHNE TOLERANZ SIND KEINE PRUEFFMASSE  
 DIMS. WITHOUT TOLERANCE ARE NOT CONTROL DIMS.

LM 5.00/.../135...



LM 5.08/.../135...

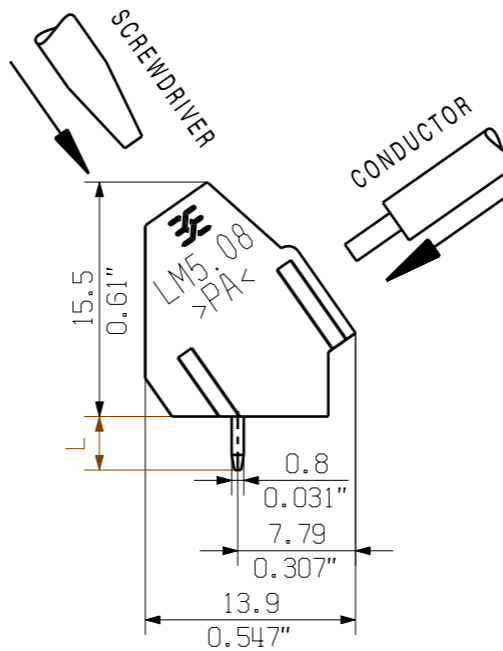

For the mounting of PCBs, it should be noted that the rated data stated in the catalog relates only to the PCB components alone.  
 The necessary creepage and clearance paths must be observed in connection with the respective applicant in accordance to IEC 664 / VDE 0110.  
 The current-carrying capacity and pitch tolerance is to be determined according to DIN IEC 326 part 3 very fine.

Weidmüller PCB components are tested to the DIN EN 61984 standard, and are valid for its field of application. Provided that the components are used to the intended purpose, all requirements with respect to the occurring of electrical, mechanical, thermic and corrosive stress will be satisfied.

24	115.00	4.528	116.84	4.600
23	110.00	4.331	111.76	4.400
22	105.00	4.134	106.68	4.200
21	100.00	3.937	101.60	4.000
20	95.00	3.740	96.52	3.800
19	90.00	3.543	91.44	3.600
18	85.00	3.346	86.36	3.400
17	80.00	3.150	81.28	3.200
16	75.00	2.953	76.20	3.000
15	70.00	2.756	71.12	2.800
14	65.00	2.559	66.04	2.600
13	60.00	2.362	60.96	2.400
12	55.00	2.165	55.88	2.200
11	50.00	1.969	50.80	2.000
10	45.00	1.772	45.72	1.800
9	40.00	1.575	40.64	1.600
8	35.00	1.378	35.56	1.400
7	30.00	1.181	30.48	1.200
6	25.00	0.984	25.40	1.000
5	20.00	0.787	20.32	0.800
4	15.00	0.591	15.24	0.600
3	10.00	0.394	10.16	0.400
2	5.00	0.197	5.08	0.200
N	L1 [mm]	L1 [inch]	L1 [mm]	L1 [inch]
	P=5.00 mm, 0.197inch		P=5.08mm, 0.200 inch	

MAX. NRN./NOS. ?		59845/5 13.05.13 XIANG_K 00		CAT.NO.: .	
MODIFICATION		Weidmüller		C 41710 08	
DRAWN 31.03.2005 XU_S		DATE NAME		DRAWING NO. ISSUE NO.	
RESPONSIBLE GE_G		DATE NAME		SHEET 01 OF 03 SHEETS	
CHECKED 14.05.2013 ZHOU_N		DATE NAME		LM 5.../.../135 ...	
APPROVED XU_S		DATE NAME		LEITERPLATTENKLEMME	
SCALE: 2/1		DATE NAME		PCB TERMINAL	
SUPERSEDES: .		DATE NAME		PRODUCT FILE: LM	
		DATE NAME		7065	

WEITERGABE SOWIE VERVIELFÄLTIGUNG DIESES DOKUMENTS, VERWERTUNG UND MITTEILUNG SEINES INHALTS SIND VERBOTEN, SOWEIT NICHT AUSDRUECKLICH GESTATTET.  
 ZUWIDERHANDLUNGEN VERPFLICHTEN ZU SCHADENERSATZ. ALLE RECHTE FUER DEN FALL DER PATENT-, GEBRAUCHSMUSTER- ODER GESCHMACKSMUSTEREINTRAGUNG VORBEHALTEN.  
 THE REPRODUCTION, DISTRIBUTION AND UTILIZATION OF THIS DOCUMENT AS WELL AS THE COMMUNICATION OF ITS CONTENTS TO OTHERS WITHOUT EXPLICIT AUTHORIZATION IS PROHIBITED.  
 OFFENDERS WILL BE HELD LIABLE FOR THE PAYMENT OF DAMAGES. WEIDMUELLER EXCLUSIVELY RESERVES THE RIGHT TO FILE FOR PATENTS, UTILITY MODELS OR DESIGNS.  
 © WEIDMUELLER INTERFACE GmbH & Co.KG

## Recommended wave soldering profiles

**Weidmüller Interface GmbH & Co. KG**  
 Klingenbergstraße 16  
 D-32758 Detmold  
 Germany  
 Fon: +49 5231 14-0  
 Fax: +49 5231 14-292083  
 www.weidmueller.com

### Single Wave:



### Double Wave:

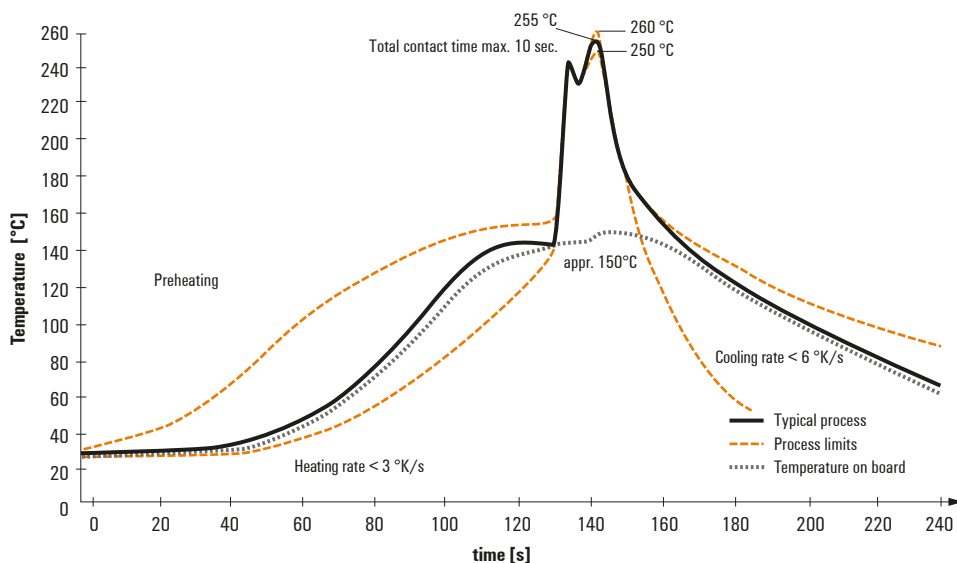

### Wave soldering profiles

Wired connection elements should be processed in accordance with the DIN EN 61760-1 standard. We have included two recommendations for practical wave soldering profiles, with which Weidmüller PCB terminals and connectors are qualified.

When choosing a suitable profile for your application, the following factors also need to be considered:

- PCB thickness
- Proportion of Cu in the layers
- Single/double-sided assembly
- Product range
- Heating and cooling rates

The single and double wave profiles each indicate the recommended operating range, including the maximum soldering temperature of 260°C. In practice, the maximum soldering temperature is quite often well below the above maximum profile.