

IE-C5DS4UG0010MBSMCS-E

Weidmüller Interface GmbH & Co. KG
Klingenbergstraße 26
D-32758 Detmold
Germany

www.weidmueller.com



Assembled IE cables, PROFINET, Cat. 5, PUR, green

General ordering data

Version	System cable, M12 D-code - flange, M12 D-code - pin straight, Cat.5 (ISO/IEC 11801) / Cat.5e (TIA T568-B), PUR, 1 m
Order No.	1244130010
Type	IE-C5DS4UG0010MBSMCS-E
GTIN (EAN)	4050118045185
Qty.	1 pc(s).

Creation date March 13, 2023 12:43:08 PM CET

Catalogue status 03.03.2023 / We reserve the right to make technical changes.

IE-C5DS4UG0010MBSMCS-E**Weidmüller Interface GmbH & Co. KG**

Klingenbergstraße 26

D-32758 Detmold

Germany

www.weidmueller.com

Technical data**Dimensions and weights**

Length	1 m	Length (inches)	39.37 inch
Net weight	92 g		

Temperatures

Storage temperature	-50 °C...70 °C	Operating temperature	-40 °C...70 °C
Operating temperature, min.	-40 °C	Operating temperature, max.	70 °C
Installation temperature	-20 °C...60 °C		

Cable structure

Cross-section	4*AWG 22/7 - 0.32 mm ²	Insulation cross-section	1.5 mm
Material sheath	PUR	Sheath diameter, max.	6.7 mm
Sheathing colour	green (RAL 6018)	Shielding	360°; shield contact

Electrical properties of cable

Category	Cat.5 (ISO/IEC 11801) / Cat.5e (TIA T568-B)
----------	--

Mechanical and material properties of cable

Halogen	halogen-free, according to IEC 60754-2	Min. bending radius, once only	5 x cable diameter
Min. bending radius, repetitive	15 x cable diameter	Resistance to spread of flame	Yes

Plug

Plug left	M12, D, IP67, female contact, straight, flange, Plastic, shielded	Plug right	M12, D, IP67, male contact, straight, plug, Plastic, shielded
-----------	---	------------	---

Plug, left

Connector left	M12 D-code – flange
----------------	---------------------

Plug, right

Connector right	M12 D-code – pin straight
-----------------	---------------------------

Classifications

ETIM 6.0	EC002599	ETIM 7.0	EC002599
ETIM 8.0	EC002599	ECLASS 9.0	27-06-03-08
ECLASS 9.1	27-06-03-08	ECLASS 10.0	27-06-03-08
ECLASS 11.0	27-06-03-08	ECLASS 12.0	27-06-03-08

Environmental Product Compliance

REACH SVHC	Lead 7439-92-1
SCIP	67cf1078-beca-4687-860b-dc475a6ec24a

Approvals

ROHS	Conform
------	---------

Creation date March 13, 2023 12:43:08 PM CET

Catalogue status 03.03.2023 / We reserve the right to make technical changes.

IE-C5DS4UG0010MBSMCS-E**Weidmüller Interface GmbH & Co. KG**

Klingenbergstraße 26

D-32758 Detmold

Germany

www.weidmueller.com**Technical data****Downloads**

Approval/Certificate/Document of Conformity	PROFINET Manufacturer's Declaration
Engineering Data	CAD data – STEP
User Documentation	MAN IE GUIDE DE MAN IE GUIDE EN
Catalogues	Catalogues in PDF-format
Brochures	FL FIELDWIRING EN PI PROFINET CABLING EN PI PROFINET CABLING EN

IE-C5DS4UG0010MBSMCS-E

Weidmüller Interface GmbH & Co. KG
 Klingenbergstraße 26
 D-32758 Detmold
 Germany

www.weidmueller.com

Drawings

Wiring diagram

M12		M12
1	yellow	1
2	white	2
3	orange	3
4	blue	4

Dimensioned drawing

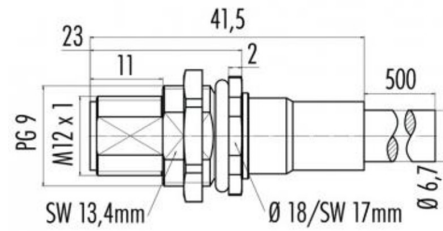

Hexagon nut enclosed loosely

Dimensioned drawing

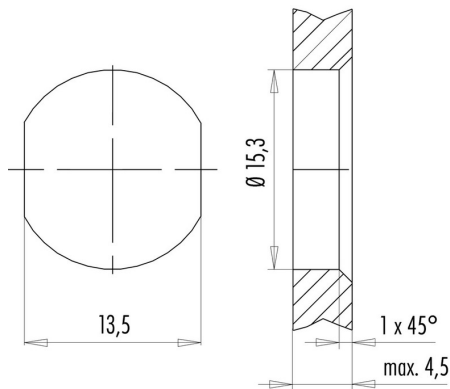

with through hole