

## LMF 5.00/11/180 3.5SN OR BX

**Weidmüller Interface GmbH & Co. KG**

Klingenbergstraße 26

D-32758 Detmold

Germany

www.weidmueller.com

### Product image

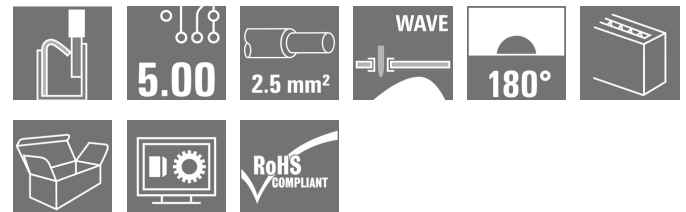

The new LMF allows us to meet the current market requirements for a PCB terminal with PUSH IN connection system for wire cross-sections up to 2.5 mm<sup>2</sup>

- PUSH IN connection system
- LMF with pusher for opening the terminal point
- LMFS without pusher, the terminal point is opened with a screwdriver
- Integrated test point
- 90° and 180° wire outlet direction

### General ordering data

Version	Printed circuit board terminals, 5.00 mm, Number of poles: 11, 180°, Solder pin length (l): 3.5 mm, tinned, orange, PUSH IN with actuator, Clamping range, max. : 2.5 mm <sup>2</sup> , Box
Order No.	<a href="#">1330280000</a>
Type	LMF 5.00/11/180 3.5SN OR BX
GTIN (EAN)	4050118133943
Qty.	25 pc(s).
Product data	IEC: 400 V / 24 A / 0.5 - 2.5 mm <sup>2</sup> UL: 300 V / 20 A / AWG 24 - AWG 12
Packaging	Box

Creation date March 7, 2023 8:42:55 PM CET

**LMF 5.00/11/180 3.5SN OR BX**
**Weidmüller Interface GmbH & Co. KG**

Klingenbergstraße 26

D-32758 Detmold

Germany

www.weidmueller.com

**Technical data**
**Dimensions and weights**

Depth	14.8 mm	Depth (inches)	0.583 inch
Height	22.7 mm	Height (inches)	0.894 inch
Height of lowest version	19.2 mm	Width	57.7 mm
Width (inches)	2.272 inch	Net weight	16.42 g

**Temperatures**

Operating temperature, min.	-50 °C	Operating temperature, max.	120 °C
-----------------------------	--------	-----------------------------	--------

**System parameters**

Product family	OMNIMATE Signal - series LMF	Wire connection method	PUSH IN with actuator
Mounting onto the PCB	THT solder connection	Conductor outlet direction	180°
Pitch in mm (P)	5 mm	Pitch in inches (P)	0.197 inch
Number of poles	11	Pin series quantity	1
Fitted by customer	No	Number of rows	1
Max. adjacent poles per row	24	Solder pin length (l)	3.5 mm
Solder pin dimensions	d = 0.8 mm	Solder eyelet hole diameter (D)	1.1 mm
Solder eyelet hole diameter tolerance (D)+	0,1 mm	Number of solder pins per pole	2
Screwdriver blade	0.6 x 3.5	Screwdriver blade standard	DIN 5264
Stripping length	10 mm	L1 in mm	50 mm
L1 in inches	1.969 inch	Touch-safe protection acc. to DIN VDE 0470	IP 20
Touch-safe protection acc. to DIN VDE 57 106	Safe from finger touch	Protection degree	IP20

**Material data**

Insulating material	Wemid (PA)	Colour	orange
Colour chart (similar)	RAL 2000	Comparative Tracking Index (CTI)	≥ 600
UL 94 flammability rating	V-0	Contact material	CuSn
Contact surface	tinned	Coating	4-6 µm SN
Tinning type	matt	Layer structure of solder connection	4...6 µm Sn matt
Storage temperature, min.	-40 °C	Storage temperature, max.	70 °C
Operating temperature, min.	-50 °C	Operating temperature, max.	120 °C
Temperature range, installation, min.	-25 °C	Temperature range, installation, max.	120 °C

**Conductors suitable for connection**

Clamping range, min.	0.12 mm <sup>2</sup>
Clamping range, max.	2.5 mm <sup>2</sup>
Wire connection cross section AWG, min.	AWG 24
Wire connection cross section AWG, max.	AWG 12
Solid, min. H05(07) V-U	0.5 mm <sup>2</sup>
Solid, max. H05(07) V-U	2.5 mm <sup>2</sup>
Flexible, min. H05(07) V-K	0.25 mm <sup>2</sup>
Flexible, max. H05(07) V-K	2.5 mm <sup>2</sup>
w. plastic collar ferrule, DIN 46228 pt 4, min.	0.25 mm <sup>2</sup>
w. plastic collar ferrule, DIN 46228 pt 4, max.	2.5 mm <sup>2</sup>
w. wire end ferrule, DIN 46228 pt 1, min.	0.25 mm <sup>2</sup>

Creation date March 7, 2023 8:42:55 PM CET

## LMF 5.00/11/180 3.5SN OR BX

**Weidmüller Interface GmbH & Co. KG**  
 Klingenbergstraße 26  
 D-32758 Detmold  
 Germany

www.weidmueller.com

## Technical data

w. wire end ferrule, DIN 46228 pt 1, max. 2.5 mm<sup>2</sup>

Plug gauge in accordance with EN 60999 a x b; ø 2.4 mm x 1.5 mm

Clampable conductor	Cross-section for conductor connection	Type	fine-wired
		nominal	0.5 mm <sup>2</sup>
wire end ferrule	wire end ferrule	Stripping length	nominal 12 mm
		Recommended wire-end ferrule	<a href="#">H0.5/16 OR</a>
		Stripping length	nominal 10 mm
		Recommended wire-end ferrule	<a href="#">H0.5/10</a>
Cross-section for conductor connection	Type	fine-wired	
	nominal	0.75 mm <sup>2</sup>	
wire end ferrule	wire end ferrule	Stripping length	nominal 12 mm
		Recommended wire-end ferrule	<a href="#">H0.75/16 W</a>
		Stripping length	nominal 10 mm
		Recommended wire-end ferrule	<a href="#">H0.75/10</a>
Cross-section for conductor connection	Type	fine-wired	
	nominal	1 mm <sup>2</sup>	
wire end ferrule	wire end ferrule	Stripping length	nominal 12 mm
		Recommended wire-end ferrule	<a href="#">H1.0/16D R</a>
		Stripping length	nominal 10 mm
		Recommended wire-end ferrule	<a href="#">H1.0/10</a>
Cross-section for conductor connection	Type	fine-wired	
	nominal	1.5 mm <sup>2</sup>	
wire end ferrule	wire end ferrule	Stripping length	nominal 10 mm
		Recommended wire-end ferrule	<a href="#">H1.5/10</a>
		Stripping length	nominal 12 mm
		Recommended wire-end ferrule	<a href="#">H1.5/16 R</a>
Cross-section for conductor connection	Type	fine-wired	
	nominal	2.5 mm <sup>2</sup>	
wire end ferrule	wire end ferrule	Stripping length	nominal 10 mm
		Recommended wire-end ferrule	<a href="#">H2.5/10</a>

Reference text Length of ferrules is to be chosen depending on the product and the rated voltage., The outside diameter of the plastic collar should not be larger than the pitch (P)

### Rated data acc. to IEC

tested acc. to standard		Rated current, min. number of poles (Tu=20°C)	
	IEC 60664-1, IEC 61984		24 A
Rated current, max. number of poles (Tu=20°C)	24 A	Rated current, min. number of poles (Tu=40°C)	24 A
Rated current, max. number of poles (Tu=40°C)	24 A	Rated voltage for surge voltage class / pollution degree II/2	400 V
Rated voltage for surge voltage class / pollution degree III/2	320 V	Rated voltage for surge voltage class / pollution degree III/3	250 V
Rated impulse voltage for surge voltage class/ pollution degree II/2	4 kV	Rated impulse voltage for surge voltage class/ pollution degree III/2	4 kV
Rated impulse voltage for surge voltage class/ contamination degree III/3	4 kV	Short-time withstand current resistance	3 x 1s with 120 A

## LMF 5.00/11/180 3.5SN OR BX

Weidmüller Interface GmbH &amp; Co. KG

Klingenbergstraße 26

D-32758 Detmold

Germany

www.weidmueller.com

## Technical data

## Rated data acc. to CSA

Institute (CSA)



Certificate No. (CSA)

200039-1815154

Rated voltage (Use group B / CSA)	300 V
Rated current (Use group B / CSA)	20 A
Wire cross-section, AWG, min.	AWG 24
Reference to approval values	Specifications are maximum values, details - see approval certificate.

Rated voltage (Use group D / CSA)	300 V
Rated current (Use group D / CSA)	10 A
Wire cross-section, AWG, max.	AWG 12

## Rated data acc. to UL 1059

Institute (cURus)



Certificate No. (cURus)

E60693

Rated voltage (Use group B / UL 1059)	300 V
Rated current (Use group B / UL 1059)	20 A
Wire cross-section, AWG, min.	AWG 24
Reference to approval values	Specifications are maximum values, details - see approval certificate.

Rated voltage (Use group D / UL 1059)	300 V
Rated current (Use group D / UL 1059)	10 A
Wire cross-section, AWG, max.	AWG 12

## Packing

Packaging	Box	VPE length	350 mm
VPE width	137 mm	VPE height	31 mm

## Type tests

Test: Durability of markings	Test	mark of origin, type identification, pitch, approval marking UL, durability
	Evaluation	available

**LMF 5.00/11/180 3.5SN OR BX**

**Weidmüller Interface GmbH & Co. KG**  
 Klingenbergstraße 26  
 D-32758 Detmold  
 Germany

www.weidmueller.com

**Technical data**

Test: Clampable cross section	Standard	DIN EN 60999-1 section 7 and 9.1 / 12.00, DIN EN 60947-1 section 8.2.4.5.1 / 12.02	
	Conductor type	Type of conductor and conductor cross-section	solid 0.14 mm <sup>2</sup>
		Type of conductor and conductor cross-section	stranded 0.14 mm <sup>2</sup>
		Type of conductor and conductor cross-section	solid 1.5 mm <sup>2</sup>
		Type of conductor and conductor cross-section	stranded 1.5 mm <sup>2</sup>
		Type of conductor and conductor cross-section	AWG 24/1
		Type of conductor and conductor cross-section	AWG 24/19
		Type of conductor and conductor cross-section	AWG 16/1
		Type of conductor and conductor cross-section	AWG 16/19
Evaluation	passed		
Test for damage to and accidental loosening of conductors	Standard	DIN EN 60999-1 section 9.4 / 12.00	
	Requirement	0.2 kg	
	Conductor type	Type of conductor and conductor cross-section	AWG 24/1
		Type of conductor and conductor cross-section	AWG 24/19
	Evaluation	passed	
	Requirement	0.3 kg	
	Conductor type	Type of conductor and conductor cross-section	stranded 0.25 mm <sup>2</sup>
		Type of conductor and conductor cross-section	solid 0.5 mm <sup>2</sup>
	Evaluation	passed	
	Requirement	0.4 kg	
	Conductor type	Type of conductor and conductor cross-section	solid 1.5 mm <sup>2</sup>
		Type of conductor and conductor cross-section	stranded 1.5 mm <sup>2</sup>
Type of conductor and conductor cross-section		AWG 16/1	
Type of conductor and conductor cross-section		AWG 16/19	
Evaluation	passed		

## LMF 5.00/11/180 3.5SN OR BX

Weidmüller Interface GmbH &amp; Co. KG

Klingenbergstraße 26

D-32758 Detmold

Germany

www.weidmueller.com

## Technical data

Pull-out test	Standard	DIN EN 60999-1 section 9.5 / 12.00		
	Requirement	≥10 N		
	Conductor type	Type of conductor and conductor cross-section	AWG 24/1	
		Type of conductor and conductor cross-section	AWG 24/19	
	Evaluation	passed		
	Requirement	≥20 N		
	Conductor type	Type of conductor and conductor cross-section	stranded 0.25 mm <sup>2</sup>	
		Type of conductor and conductor cross-section	H05V-K0.5	
	Evaluation	passed		
	Requirement	≥40 N		
	Conductor type	Type of conductor and conductor cross-section	H07V-U1.5	
		Type of conductor and conductor cross-section	H07V-K1.5	
		Type of conductor and conductor cross-section	AWG 16/1	
		Type of conductor and conductor cross-section	AWG 16/19	
	Evaluation	passed		

## Classifications

ETIM 6.0	EC002643	ETIM 7.0	EC002643
ETIM 8.0	EC002643	ECLASS 9.0	27-44-04-01
ECLASS 9.1	27-44-04-01	ECLASS 10.0	27-44-04-01
ECLASS 11.0	27-46-01-01	ECLASS 12.0	27-46-01-01

## Important note

IPC conformity Conformity: The products are developed, manufactured and delivered according international recognized standards and norms and comply with the assured properties in the data sheet resp. fulfill decorative properties in accordance with IPC-A-610 "Class 2". Further claims on the products can be evaluated on request.

Notes

- Additional variants on request
- Rated current related to rated cross-section & min. No. of poles.
- Wire end ferrule without plastic collar to DIN 46228/1
- Wire end ferrule with plastic collar to DIN 46228/4
- P on drawing = pitch
- Rated data refer only to the component itself. Clearance and creepage distances to other components are to be designed in accordance with the relevant application standards.
- The test point can only be used as potential-pickup point.
- Long term storage of the product with average temperature of 50 °C and average humidity 70%, 36 months

Creation date March 7, 2023 8:42:55 PM CET

Catalogue status 03.03.2023 / We reserve the right to make technical changes.

6

## LMF 5.00/11/180 3.5SN OR BX

**Weidmüller Interface GmbH & Co. KG**  
Klingenbergstraße 26  
D-32758 Detmold  
Germany

[www.weidmueller.com](http://www.weidmueller.com)

# Technical data

## Approvals

Approvals



ROHS	Conform
UL File Number Search	UL Website
Certificate No. (cURus)	E60693

## Downloads

Approval/Certificate/Document of Conformity	<a href="#">Declaration of the Manufacturer</a>
Engineering Data	<a href="#">CAD data – STEP</a>
Engineering Data	<a href="#">WSCAD</a>
Catalogues	<a href="#">Catalogues in PDF-format</a>
Brochures	<a href="#">FL DRIVES EN</a> <a href="#">FL ANALO.SIGN.CONV. EN</a> <a href="#">MB DEVICE MANUF. EN</a> <a href="#">FL DRIVES DE</a> <a href="#">FL BUILDING SAFETY EN</a> <a href="#">FL APPL LED LIGHTING EN</a> <a href="#">FL INDUSTR.CONTROLS EN</a> <a href="#">FL MACHINE SAFETY EN</a> <a href="#">FL HEATING ELECTR EN</a> <a href="#">FL APPL INVERTER EN</a> <a href="#">FL BASE STATION EN</a> <a href="#">FL ELEVATOR EN</a> <a href="#">FL POWER SUPPLY EN</a> <a href="#">FL 72H SAMPLE SER EN</a> <a href="#">PO OMNIMATE EN</a> <a href="#">PO OMNIMATE EN</a>

**LMF 5.00/11/180 3.5SN OR BX**

**Weidmüller Interface GmbH & Co. KG**  
 Klingenbergstraße 26  
 D-32758 Detmold  
 Germany

www.weidmueller.com

**Drawings**

**Product image**

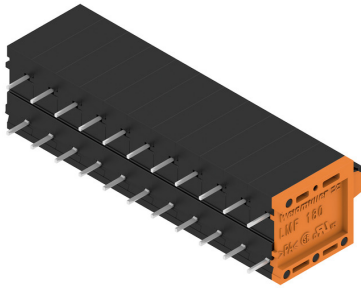

**Dimensional drawing**

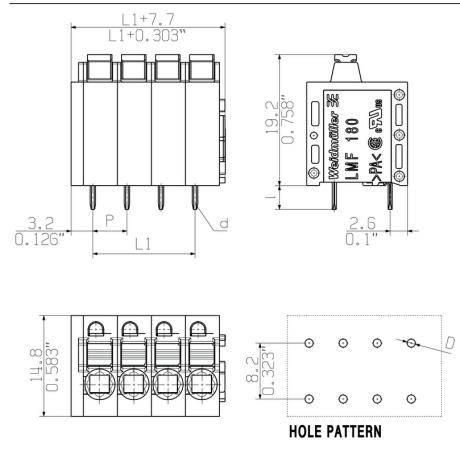

**Graph**

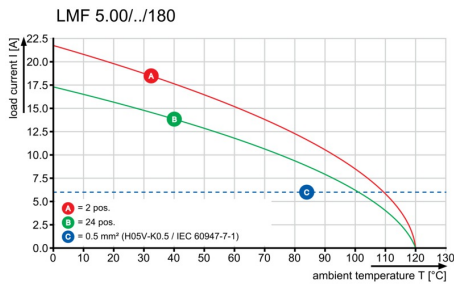

**Graph**

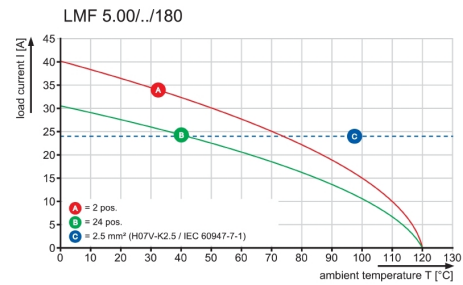

**Product benefits**



Optional conductor outlet direction  
 Stable mechanical design

**Product benefits**



High reliability of the current capacity



**LMF 5.00/11/180 3.5SN OR BX**

**Weidmüller Interface GmbH & Co. KG**  
Klingenbergstraße 26  
D-32758 Detmold  
Germany

[www.weidmueller.com](http://www.weidmueller.com)

Drawings

Product benefits



Direct conductor entry  
Cross section up to 2.5 mm<sup>2</sup>

Product benefits



Maintenance through test point

MASSE OHNE TOLERANZ SIND KEINE PRUEFMASSE  
 DIMS. WITHOUT TOLERANCE ARE NOT CONTROL DIMS.

DIE DEUTSCHE VERSION IST VERBINDLICH  
 THE GERMAN VERSION IS BINDING

ALLGEMEINGUELTIGE KUNDENZEICHUNG, AKTUELLER STAND NUR AUF ANFRAGE  
 GENERAL CUSTOMER DRAWING, TOPICAL VERSION ONLY IF REQUIRED

SHOWN: LMF 5.00/04/180 3.5

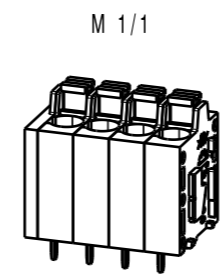
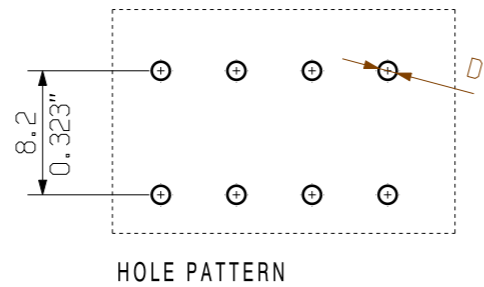
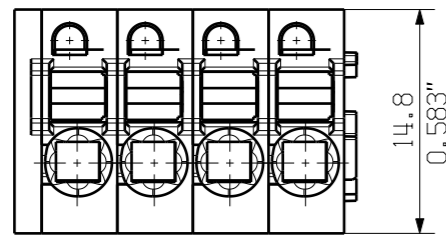
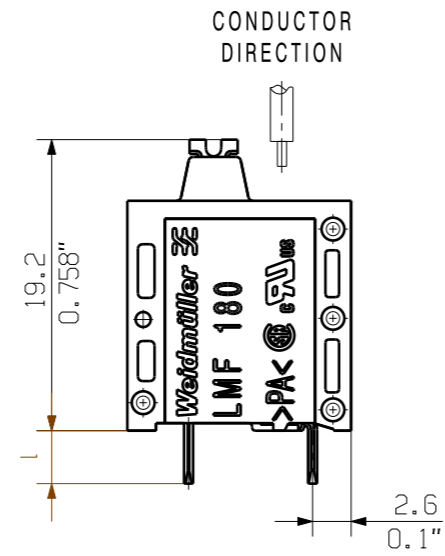

SHOWN: LMFS 5.00/04/180 3.5

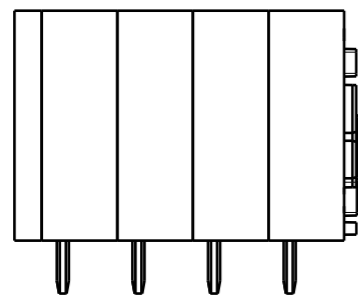

SCREWDRIVER AND  
 CONDUCTOR DIRECTION

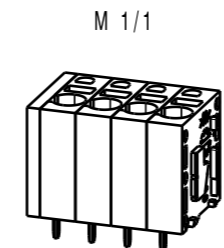
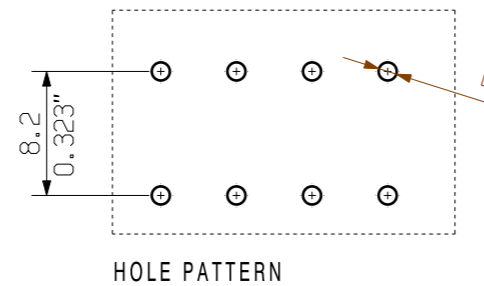
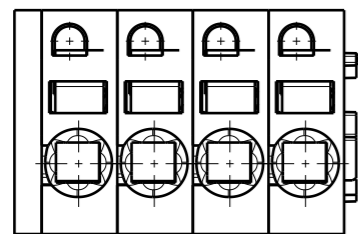
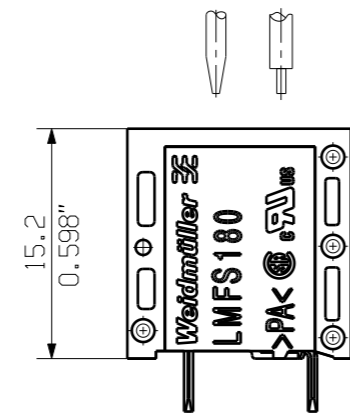

P = 5.00 RASTER PITCH  
 D = Ø1.1 +0.1 / 0.043"  
 d = 0.6x0.8 / 0.024"x0.031"  
 l = 3.5 / 0.138"

For the mounting of PCBs, it should be noted that the rated data relates only to the PCB components alone.  
 The necessary creepage and clearance paths must be observed in connection with the respective applicant in accordance to IEC 664 / VDE 0110.  
 The current-carrying capacity and pitch tolerance is to be determined according to DIN IEC 326 part 3 very fine.  
 Weidmüller PCB components are tested to the DIN EN 61984 standard, and are valid for its field of application.  
 Provided that the components are used to the intended purpose, all requirements with respect to the occurring of electrical, mechanical, thermic and corrosive stress will be satisfied.

24	115.00	4.528
23	110.00	4.331
22	105.00	4.134
21	100.00	3.937
20	95.00	3.740
19	90.00	3.543
18	85.00	3.346
17	80.00	3.150
16	75.00	2.953
15	70.00	2.756
14	65.00	2.559
13	60.00	2.362
12	55.00	2.165
11	50.00	1.969
10	45.00	1.772
9	40.00	1.575
8	35.00	1.378
7	30.00	1.181
6	25.00	0.984
5	20.00	0.787
4	15.00	0.591
3	10.00	0.394
2	5.00	0.197
n POLES	POLZAHL [mm]	L1 [inch]

GENERAL TOLERANCE: DIN ISO 2768-m		70657/4 26.06.13 TIELKER_S 01		CAT.NO.: . . . . .	
		MODIFICATION			
		DATE	NAME	<b>C 55662 03</b> DRAWING NO. ISSUE NO. SHEET 01 OF 01 SHEETS	
SCALE: 2/1		DRAWN	25.01.2012	REGLIN_A	<b>LMF... 5.00/.../180 ...</b> LEITERPLATTENKLEMME PCB TERMINAL
SUPERSEDES: .		RESPONSIBLE		SCHMITZ_T	
		CHECKED	26.06.2013	HECKERT_M	
		APPROVED		HANKE_D	PRODUCT FILE: LMF 5.0X 7403

WEITERGABE SOWIE VERVIELFÄLTIGUNG DIESES DOKUMENTS, VERWERTUNG UND MITTEILUNG SEINES INHALTS SIND VERBOTEN, SOWEIT NICHT AUSDRUECKLICH GESTATTET.  
 ZUWIDERHANDLUNGEN VERPFLICHTEN ZU SCHADENERSATZ. ALLE RECHTE FUER DEN FALL DER PATENT-, GEBRAUCHSMUSTER-, ODER GESCHMACKSMUSTERENTRAGUNG VORBEHALTEN.  
 THE REPRODUCTION, DISTRIBUTION AND UTILIZATION OF THIS DOCUMENT AS WELL AS THE COMMUNICATION OF ITS CONTENTS TO OTHERS WITHOUT EXPLICIT AUTHORIZATION IS PROHIBITED.  
 OFFENDERS WILL BE HELD LIABLE FOR THE PAYMENT OF DAMAGES. WEIDMUELLER EXCLUSIVELY RESERVES THE RIGHT TO FILE FOR PATENTS, UTILITY MODELS OR DESIGNS.  
 © WEIDMUELLER INTERFACE GmbH & Co.KG

## Recommended wave soldering profiles

**Weidmüller Interface GmbH & Co. KG**  
 Klängenbergstraße 16  
 D-32758 Detmold  
 Germany  
 Fon: +49 5231 14-0  
 Fax: +49 5231 14-292083  
 www.weidmueller.com

### Single Wave:



### Double Wave:



### Wave soldering profiles

Wired connection elements should be processed in accordance with the DIN EN 61760-1 standard. We have included two recommendations for practical wave soldering profiles, with which Weidmüller PCB terminals and connectors are qualified.

When choosing a suitable profile for your application, the following factors also need to be considered:

- PCB thickness
- Proportion of Cu in the layers
- Single/double-sided assembly
- Product range
- Heating and cooling rates

The single and double wave profiles each indicate the recommended operating range, including the maximum soldering temperature of 260°C. In practice, the maximum soldering temperature is quite often well below the above maximum profile.