

LM2N 3.50/16/90 3.2SN OR BX

Weidmüller Interfaces GmbH & Co. KG

Postfach 3030

32760 Detmold

Tel. +49 5231 14-0

Fax. +49 5231 14-2083

info@weidmueller.com

www.weidmueller.com

Product image



Similar to illustration

Small, compact PCB terminal or -tier PCB terminal with proven clamping yoke connection and 3.5 mm pitch. Suitable for conductor cross-sections up to 1.5 mm².

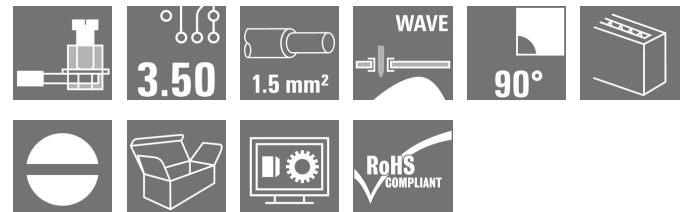

General ordering data

Version	Printed circuit board terminals, 3.50 mm, Number of poles: 16, 90°, Solder pin length (l): 3.2 mm, tinned, orange, Clamping yoke connection, Clamping range, max. : 2.08 mm ² , Box
Order No.	1703760000
Type	LM2N 3.50/16/90 3.2SN OR BX
GTIN (EAN)	4008190910839
Qty.	50 pc(s).
Product data	IEC: 320 V / 13 A / 0.5 - 1.5 mm ² UL: 300 V / 10 A / AWG 28 - AWG 14
Packaging	Box

LM2N 3.50/16/90 3.2SN OR BX

Weidmüller Interfaces GmbH & Co. KG

Postfach 3030

32760 Detmold

Tel. +49 5231 14-0

Fax. +49 5231 14-2083

info@weidmueller.com

www.weidmueller.com

Technical data

Dimensions and weights

Depth	16.75 mm	Depth (inches)	0.659 inch
Height	27.3 mm	Height (inches)	1.075 inch
Height of lowest version	24.1 mm	Width	30.35 mm
Width (inches)	1.195 inch	Net weight	12.22 g

Temperatures

Operating temperature, min.	-50 °C	Operating temperature, max.	100 °C
-----------------------------	--------	-----------------------------	--------

System parameters

Product family	OMNIMATE Signal - series LM	Wire connection method	Clamping yoke connection
Mounting onto the PCB	THT solder connection	Conductor outlet direction	90°
Pitch in mm (P)	3.5 mm	Pitch in inches (P)	0.138 inch
Number of poles	16	Pin series quantity	2
Fitted by customer	Yes	Number of rows	2
Max. adjacent poles per row	24	Solder pin length (l)	3.2 mm
Solder pin dimensions	1.0 x 0.6 mm	Solder eyelet hole diameter (D)	1.3 mm
Solder eyelet hole diameter tolerance (D)	+ 0,1 mm	Number of solder pins per pole	1
Screwdriver blade	0.4 x 2.5	Screwdriver blade standard	DIN 5264
Tightening torque, min.	0.2 Nm	Tightening torque, max.	0.2 Nm
Clamping screw	M 2	Stripping length	5 mm
L1 in mm	24.5 mm	L1 in inches	0.965 inch
Touch-safe protection acc. to DIN VDE 0470	IP 20	Touch-safe protection acc. to DIN VDE 57 106	Safe from finger touch
Protection degree	IP20	Volume resistance	3.60 mΩ

Material data

Insulating material	PA	Colour	orange
Colour chart (similar)	RAL 2000	Insulating material group	I
Comparative Tracking Index (CTI)	≥ 600	UL 94 flammability rating	V-2
Contact material	Copper alloy	Contact surface	tinned
Coating	1-3 µm Ni, 4-6 µm SN	Tinning type	matt
Layer structure of solder connection	1.5...3 µm Ni / 4...6 µm Sn matt	Storage temperature, min.	-40 °C
Storage temperature, max.	70 °C	Operating temperature, min.	-50 °C
Operating temperature, max.	100 °C	Temperature range, installation, min.	-25 °C
Temperature range, installation, max.	100 °C		

Conductors suitable for connection

Clamping range, min.	0.08 mm ²
Clamping range, max.	2.08 mm ²
Wire connection cross section AWG, min.	AWG 28
Wire connection cross section AWG, max.	AWG 14
Solid, min. H05(07) V-U	0.5 mm ²
Solid, max. H05(07) V-U	1.5 mm ²
Flexible, min. H05(07) V-K	0.5 mm ²
Flexible, max. H05(07) V-K	1.5 mm ²
w. plastic collar ferrule, DIN 46228 pt 4, 0.5 mm ² min.	

Creation date March 3, 2023 9:24:48 AM CET

Catalogue status 18.02.2023 / We reserve the right to make technical changes.

2

LM2N 3.50/16/90 3.2SN OR BX

Weidmüller Interfaces GmbH & Co. KG

Postfach 3030

32760 Detmold

Tel. +49 5231 14-0

Fax. +49 5231 14-2083

info@weidmueller.com

www.weidmueller.com

Technical data

w. plastic collar ferrule, DIN 46228 pt 4, 0.75 mm²
max.

Plug gauge in accordance with EN 60999 a x b; ø 2.4 mm x 1.5 mm

Clampable conductor

Cross-section for conductor connection

Type fine-wired

nominal 0.75 mm²

wire end ferrule

Stripping length nominal 8 mm

Recommended wire-end ferrule [HO.75/12 W](#)

Reference text

Length of ferrules is to be chosen depending on the product and the rated voltage., The outside diameter of the plastic collar should not be larger than the pitch (P)

Rated data acc. to IEC

tested acc. to standard

IEC 60664-1, IEC 61984

Rated current, max. number of poles (Tu=20°C)

12 A

Rated current, min. number of poles (Tu=20°C)

13 A

Rated current, max. number of poles (Tu=40°C)

10 A

Rated current, min. number of poles (Tu=40°C)

11 A

Rated voltage for surge voltage class / pollution degree III/2

160 V

Rated voltage for surge voltage class / pollution degree II/2

320 V

Rated impulse voltage for surge voltage class/ pollution degree II/2

2.5 kV

Rated voltage for surge voltage class / pollution degree III/3

160 V

Rated impulse voltage for surge voltage class/ contamination degree III/3

2.5 kV

Rated impulse voltage for surge voltage class/ pollution degree III/2

2.5 kV

Short-time withstand current resistance

3 x 1s with 72 A

Rated data acc. to CSA

Institute (CSA)



Certificate No. (CSA)

154685-1202192

Rated voltage (Use group B / CSA)

300 V

Rated voltage (Use group D / CSA)

300 V

Rated current (Use group B / CSA)

10 A

Rated current (Use group D / CSA)

10 A

Wire cross-section, AWG, min.

AWG 28

Wire cross-section, AWG, max.

AWG 14

Reference to approval values

Specifications are maximum values, details - see approval certificate.

Rated data acc. to UL 1059

Institute (UR)



Certificate No. (UR)

E60693

Rated voltage (Use group B / UL 1059)

300 V

Rated voltage (Use group D / UL 1059)

300 V

Rated current (Use group B / UL 1059)

10 A

Rated current (Use group D / UL 1059)

10 A

Wire cross-section, AWG, min.

AWG 28

Wire cross-section, AWG, max.

AWG 14

Reference to approval values

Specifications are maximum values, details - see approval certificate.

Packing

Packaging

Box

VPE length

161 mm

VPE width

106 mm

VPE height

55 mm

Creation date March 3, 2023 9:24:48 AM CET

Catalogue status 18.02.2023 / We reserve the right to make technical changes.

3

LM2N 3.50/16/90 3.2SN OR BX

Weidmüller Interfaces GmbH & Co. KG

Postfach 3030

32760 Detmold

Tel. +49 5231 14-0

Fax. +49 5231 14-2083

info@weidmueller.com

www.weidmueller.com

Technical data

Classifications

ETIM 6.0	EC002643	ETIM 7.0	EC002643
ETIM 8.0	EC002643	ECLASS 9.0	27-44-04-01
ECLASS 9.1	27-44-04-01	ECLASS 10.0	27-44-04-01
ECLASS 11.0	27-46-01-01	ECLASS 12.0	27-46-01-01

Important note

IPC conformity Conformity: The products are developed, manufactured and delivered according international recognized standards and norms and comply with the assured properties in the data sheet resp. fulfill decorative properties in accordance with IPC-A-610 "Class 2". Further claims on the products can be evaluated on request.

- Notes
- Additional variants on request
 - Rated current related to rated cross-section & min. No. of poles.
 - Max. outer diameter of the conductor: 2.9 mm
 - Wire end ferrule with plastic collar to DIN 46228/4
 - P on drawing = pitch
 - Rated data refer only to the component itself. Clearance and creepage distances to other components are to be designed in accordance with the relevant application standards.
 - Long term storage of the product with average temperature of 50 °C and average humidity 70%, 36 months

Approvals

Approvals



ROHS	Conform
UL File Number Search	UL Website
Certificate No. (UR)	E60693

LM2N 3.50/16/90 3.2SN OR BX

Weidmüller Interfaces GmbH & Co. KG

Postfach 3030

32760 Detmold

Tel. +49 5231 14-0

Fax. +49 5231 14-2083

info@weidmueller.com

www.weidmueller.com

Technical data

Downloads

Approval/Certificate/Document of Conformity	Declaration of the Manufacturer
Engineering Data	CAD data – STEP
Engineering Data	WSCAD
Catalogues	Catalogues in PDF-format
Brochures	FL DRIVES EN
	FL ANALO.SIGN.CONV. EN
	MB DEVICE MANUF. EN
	FL DRIVES DE
	FL BUILDING SAFETY EN
	FL APPL LED LIGHTING EN
	FLIndustr.CONTROLS EN
	FL MACHINE SAFETY EN
	FL HEATING ELECTR EN
	FL APPL INVERTER EN
	FL_BASE_STATION_EN
	FL ELEVATOR EN
	FL POWER SUPPLY EN
FL 72H SAMPLE SER EN	
PO OMNIMATE EN	
PO OMNIMATE EN	

Data sheet

LM2N 3.50/16/90 3.2SN OR BX

Weidmüller Interfaces GmbH & Co. KG

Postfach 3030

32760 Detmold

Tel. +49 5231 14-0

Fax. +49 5231 14-2083

Drawings

Dimensional drawing info@weidmueller.com

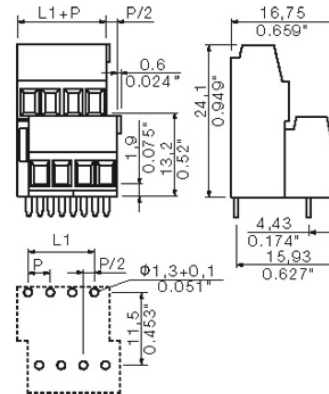

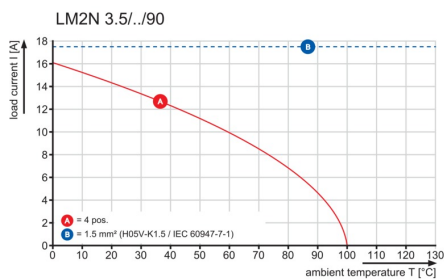

Graph



WEITERGABE SOWIE VERVIELFÄLTIGUNG DIESES DOKUMENTS, VERWERTUNG UND MITTEILUNG SEINES INHALTS SIND VERBOTEN, SOWEIT NICHT AUSDRUECKLICH GESTATTET.
 ZUWIDERHANDLUNGEN VERPFLICHTEN ZU SCHADENERSATZ. ALLE RECHTE FUER DEN FALL DER PATENT-, GEBRAUCHSMUSTER- ODER GESCHMACKSMUSTERREINTRAGUNG VORBEHALTEN.
 THE REPRODUCTION, DISTRIBUTION AND UTILIZATION OF THIS DOCUMENT AS WELL AS THE COMMUNICATION OF ITS CONTENTS TO OTHERS WITHOUT EXPLICIT AUTHORIZATION IS PROHIBITED.
 OFFENDERS WILL BE HELD LIABLE FOR THE PAYMENT OF DAMAGES. WEIDMUELLER EXCLUSIVELY RESERVES THE RIGHT TO FILE FOR PATENTS, UTILITY MODELS OR DESIGNS.

Technical Data

Rev.		
Material data		
Insulation material type		PA 66
Insulation material colours		orange/black
Insulation material flammability class	UL94	V - 2
Insulation resistance	MOhm	10 ³
Contact base material		Cu-alloy
Contact plating		tin-plated
System characteristic values		
Pitch P	mm/inch	3.5/0.138
Number of rows		2
Dielectric strength (r.m.s withstand voltage)	kV	>1.5
Through resistance (typical)	mOhm	2.2
Operating temperature range	°C	-55°...+100° 1)
Degree of protection acc. to VDE 0106		finger safe
Degree of protection acc. to DIN EN 60529		IP20
Conductor connection method		clamping yoke
Screw size		M2
Screw torque max. acc. to EN 60999	Nm	0.2
Screw driver type		SDI 0.4x2.5
Solder pin length L	mm/inch	3.2/0.126
PCB hole diameter D (wave soldering)	mm/inch	1.3+0.1/0.051+0.004 2)
PCB hole diameter D (reflow soldering)	mm/inch	n.a. 3)
Resistance to soldering heat acc. to DIN IEC 60512-6	°C/sec	260/10 4)
Resistance to soldering heat acc. to EN 61760-1	°C/sec	n.a. 5)
Solderability classification acc. to EN 61760-1		n.a.
Solder connection type		wave soldering
Solder pin diameter d (max.)	mm/inch	1.22/0.048
Application notes		
Coding possibility	yes/no	no
Joinable without loss of pitch	yes/no	no
Manual assembly of modules	yes/no	yes
Max. number of poles	n	48
Conductor		
Clamping range	mm ²	0.08...1.5
"e" solid H05(07) V-U	mm ²	0.08...1.5
"f" flexible H05(07) V-K	mm ²	0.08...1.5
"f" with ferrule acc. to DIN 46228/1	mm ²	n.a.
... with plastic collar acc. to DIN 46228/4	mm ²	n.a.
Conductor insulation stripping length	mm/inch	5/0.197
Conductor insulation diameter max.	mm/inch	n.a.
Two wire clamping range	mm ²	0.5
Gauge to EN 60999 (a x b ; Ø)	mm	2.4x1.5
IEC 664-1 / VDE0110 (4.97) rated data		
Rated cross section acc. to EN 60999	mm ²	1.5
Rated current @ 20°C ambient	A	10 6)
Rated current @ 40°C ambient	A	8.5 6)
Overvoltage category / Pollution degree		
Rated voltage	V	III/3 III/2 II/2
Rated impulse voltage	kV	160 160 320
		2.5 2.5 2.5
UL 1059 rated data  File No.: E60693		
Rated voltage		B C D
		300 --- 300
Rated current		10 --- 10
AWG wire range (field wiring / factory wiring)		28...14
CSA C22.2 rated data  File No.: LR12400		
Rated voltage		B C D
		300 --- 300
Rated current		10 --- 10
AWG wire range (field wiring / factory wiring)		28...14
Packaging		
		carton
Downloads		
		www.weidmueller.de

- Sum of ambient temperature and temperature rise
- Recommendation for manual assembly
- Recommendation for automatic assembly
- Recommendation for wave soldering
- Recommendation for reflow soldering
- Referred to rated cross section and 12 pole number

n.a. = not applicable

Subject to technical changes

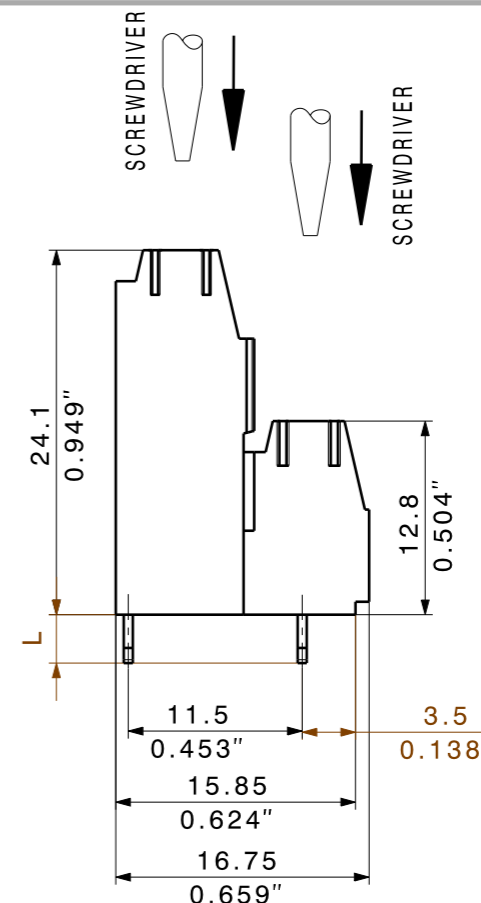
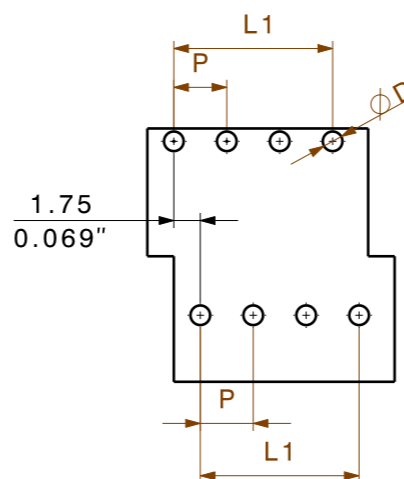
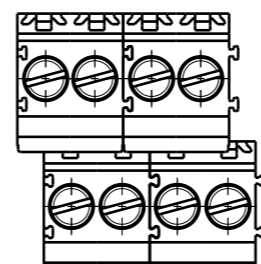
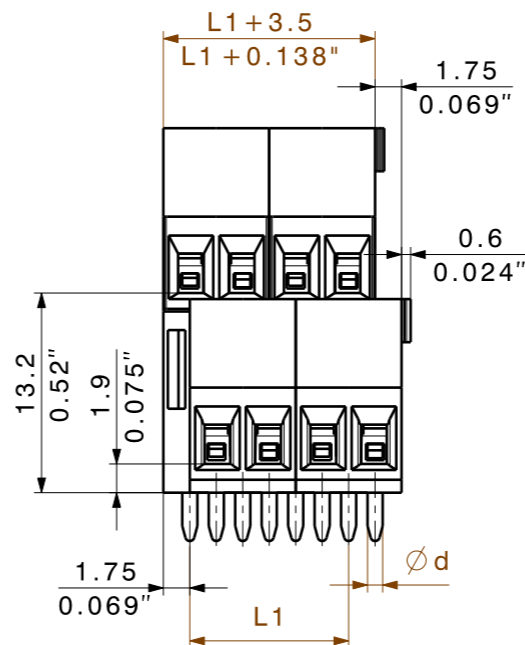

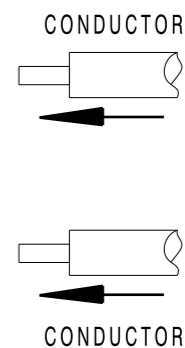

DIE DEUTSCHE VERSION IST VERBINDLICH
THE GERMAN VERSION IS BINDING



48	80,50	3,169
46	77,00	3,031
44	73,50	2,894
42	70,00	2,756
40	66,50	2,618
38	63,00	2,480
36	59,50	2,343
34	56,00	2,205
32	52,50	2,067
30	49,00	1,929
28	45,50	1,791
26	42,00	1,654
24	38,50	1,516
22	35,00	1,378
20	31,50	1,240
18	28,00	1,102
16	24,50	0,965
14	21,00	0,827
12	17,50	0,689
10	14,00	0,551
8	10,50	0,413
6	7,00	0,276
4	3,50	0,138
n	L1 [mm]	L1 [inch]

SHOWN LM2N3.5/8/90

 METRIC TOLERANCES X. = ±0.3 X.X = ±0.1 X.XX = ±0.05	43264/5 17.06.09 HELIS_MA 00	CAT.NO.:	
			C 23209 08 DRAWING NO. ISSUE NO. SHEET 02 OF 03 SHEETS
MODIFICATION		DATE	NAME
DRAWN		23.09.2008	HELIS_MA
RESPONSIBLE			KRUG_M
CHECKED		18.06.2009	HECKERT_M
APPROVED			HECKERT_M
SCALE: 5/1	PRODUCT FILE: LM1N 3.5		
SUPERSEDES: .	1111		

For the mounting of PCBs, it should be noted that the rated data stated here relates only to the PCB components alone.
The necessary creepage and clearance paths must be observed in connection with the respective applicant in accordance to IEC 664 / VDE 0110.
The current-carrying capacity and pitch tolerance is to be determined according to DIN IEC 326 part 3 very fine.

Weidmüller PCB components are tested to the DIN EN 61984 standard, and are valid for its field of application. Provided that the components are used to the intended purpose, all requirements with respect to the occurring of electrical, mechanical, thermic and corrosive stress will be satisfied.

LM2N 3.5/././90
LEITERPLATTENANSCHLUSSKLEMME
PCB TERMINAL

Recommended wave soldering profiles

Weidmüller Interface GmbH & Co. KG
 Klingenbergstraße 16
 D-32758 Detmold
 Germany
 Fon: +49 5231 14-0
 Fax: +49 5231 14-292083
 www.weidmueller.com

Single Wave:



Double Wave:



Wave soldering profiles

Wired connection elements should be processed in accordance with the DIN EN 61760-1 standard. We have included two recommendations for practical wave soldering profiles, with which Weidmüller PCB terminals and connectors are qualified.

When choosing a suitable profile for your application, the following factors also need to be considered:

- PCB thickness
- Proportion of Cu in the layers
- Single/double-sided assembly
- Product range
- Heating and cooling rates

The single and double wave profiles each indicate the recommended operating range, including the maximum soldering temperature of 260°C. In practice, the maximum soldering temperature is quite often well below the above maximum profile.