

LM2H 5.08/30/90 3.5SN OR BX

Weidmüller Interface GmbH & Co. KG

Klingenbergstraße 26

D-32758 Detmold

Germany

www.weidmueller.com

Product image

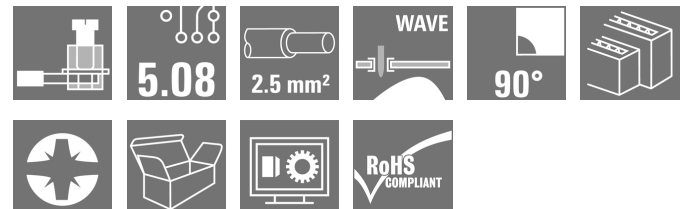

Similar to illustration

Low and high 1-row PCB terminal with proven clamping yoke connection at 5.08 mm pitch, conductor outlet direction 90°. Suitable for conductor cross-sections up to 2.5 mm².

General ordering data

Version	Printed circuit board terminals, 5.08 mm, Number of poles: 30, 90°, Solder pin length (l): 3.5 mm, tinned, orange, Clamping yoke connection, Clamping range, max. : 2.5 mm ² , Box
Order No.	1769370000
Type	LM2H 5.08/30/90 3.5SN OR BX
GTIN (EAN)	4032248116423
Qty.	10 pc(s).
Product data	IEC: 630 V / 17.5 A / 0.2 - 2.5 mm ² UL: 300 V / 15 A / AWG 24 - AWG 14
Packaging	Box

Creation date February 20, 2023 1:51:47 PM CET

LM2H 5.08/30/90 3.5SN OR BX

Weidmüller Interface GmbH & Co. KG

Klingenbergstraße 26

D-32758 Detmold

Germany

www.weidmueller.com

Technical data

Dimensions and weights

Depth	22.8 mm	Depth (inches)	0.898 inch
Height	40.1 mm	Height (inches)	1.579 inch
Height of lowest version	36.6 mm	Width	79.74 mm
Width (inches)	3.139 inch	Net weight	61.8 g

Temperatures

Operating temperature, min.	-50 °C	Operating temperature, max.	120 °C
-----------------------------	--------	-----------------------------	--------

System parameters

Product family	OMNIMATE Signal - series LM	Wire connection method	Clamping yoke connection
Mounting onto the PCB	THT solder connection	Conductor outlet direction	90°
Pitch in mm (P)	5.08 mm	Pitch in inches (P)	0.2 inch
Number of poles	30	Pin series quantity	2
Fitted by customer	Yes	Number of rows	2
Max. adjacent poles per row	48	Solder pin length (l)	3.5 mm
Solder pin dimensions	0.95 x 0.8 mm	Solder eyelet hole diameter (D)	1.3 mm
Solder eyelet hole diameter tolerance (D)+	0,1 mm	Number of solder pins per pole	1
Screwdriver blade	0.6 x 3.5	Screwdriver blade standard	DIN 5264
Tightening torque, min.	0.4 Nm	Tightening torque, max.	0.5 Nm
Clamping screw	M 2.5	Stripping length	6 mm
L1 in mm	71.12 mm	L1 in inches	2.8 inch
Touch-safe protection acc. to DIN VDE 0470	IP 20	Touch-safe protection acc. to DIN VDE 57 106	Safe from finger touch
Protection degree	IP20	Volume resistance	1.20 mΩ

Material data

Insulating material	Wemid (PA)	Colour	orange
Colour chart (similar)	RAL 2000	Insulating material group	I
Comparative Tracking Index (CTI)	≥ 600	UL 94 flammability rating	V-0
Contact material	Copper alloy	Contact surface	tinned
Coating	1-3 µm Ni, 4-6 µm SN	Tinning type	matt
Layer structure of solder connection	1...3 µm Ni / 4...6 µm Sn matt	Storage temperature, min.	-40 °C
Storage temperature, max.	70 °C	Operating temperature, min.	-50 °C
Operating temperature, max.	120 °C	Temperature range, installation, min.	-25 °C
Temperature range, installation, max.	120 °C		

Conductors suitable for connection

Clamping range, min.	0.2 mm ²
Clamping range, max.	2.5 mm ²
Wire connection cross section AWG, min.	AWG 24
Wire connection cross section AWG, max.	AWG 14
Solid, min. H05(07) V-U	0.2 mm ²
Solid, max. H05(07) V-U	2.5 mm ²
Flexible, min. H05(07) V-K	0.2 mm ²
Flexible, max. H05(07) V-K	2.5 mm ²
w. plastic collar ferrule, DIN 46228 pt 4,	0.25 mm ² min.

Creation date February 20, 2023 1:51:47 PM CET

Catalogue status 03.02.2023 / We reserve the right to make technical changes.

LM2H 5.08/30/90 3.5SN OR BX

Weidmüller Interface GmbH & Co. KG
 Klingenbergstraße 26
 D-32758 Detmold
 Germany

www.weidmueller.com

Technical data

w. plastic collar ferrule, DIN 46228 pt 4, 1.5 mm²
 max.

w. wire end ferrule, DIN 46228 pt 1, 0.25 mm²
 min.

w. wire end ferrule, DIN 46228 pt 1, 1.5 mm²
 max.

Plug gauge in accordance with EN 60999 a x b; ø 2.4 mm x 1.5 mm; 1.9mm

Clampable conductor	Cross-section for conductor connection	Type	fine-wired
		nominal	0.5 mm ²
wire end ferrule	Stripping length	nominal	8 mm
		Recommended wire-end ferrule	H0.5/12 OR
	Stripping length	nominal	6 mm
		Recommended wire-end ferrule	H0.5/6
Cross-section for conductor connection	Type	fine-wired	
	nominal	0.75 mm ²	
wire end ferrule	Stripping length	nominal	8 mm
		Recommended wire-end ferrule	H0.75/12 W
	Stripping length	nominal	6 mm
		Recommended wire-end ferrule	H0.75/6
Cross-section for conductor connection	Type	fine-wired	
	nominal	1 mm ²	
wire end ferrule	Stripping length	nominal	8 mm
		Recommended wire-end ferrule	H1.0/12 GE
	Stripping length	nominal	6 mm
		Recommended wire-end ferrule	H1.0/6
Cross-section for conductor connection	Type	fine-wired	
	nominal	0.25 mm ²	
wire end ferrule	Stripping length	nominal	8 mm
		Recommended wire-end ferrule	H0.25/10 HBL
	Stripping length	nominal	5 mm
		Recommended wire-end ferrule	H0.25/5
Cross-section for conductor connection	Type	fine-wired	
	nominal	0.34 mm ²	
wire end ferrule	Stripping length	nominal	8 mm
	Recommended wire-end ferrule	H0.34/10 TK	

Reference text Length of ferrules is to be chosen depending on the product and the rated voltage., The outside diameter of the plastic collar should not be larger than the pitch (P)

LM2H 5.08/30/90 3.5SN OR BX

Weidmüller Interface GmbH & Co. KG

Klingenbergstraße 26

D-32758 Detmold

Germany

www.weidmueller.com

Technical data

Rated data acc. to IEC

tested acc. to standard	IEC 60664-1, IEC 61984	Rated current, min. number of poles (Tu=20°C)	17.5 A
Rated current, max. number of poles (Tu=20°C)	16 A	Rated current, min. number of poles (Tu=40°C)	17.5 A
Rated current, max. number of poles (Tu=40°C)	14.2 A	Rated voltage for surge voltage class / pollution degree II/2	630 V
Rated voltage for surge voltage class / pollution degree III/2	320 V	Rated voltage for surge voltage class / pollution degree III/3	250 V
Rated impulse voltage for surge voltage class/ pollution degree II/2	4 kV	Rated impulse voltage for surge voltage class/ pollution degree III/2	4 kV
Rated impulse voltage for surge voltage class/ contamination degree III/3	4 kV	Short-time withstand current resistance	3 x 1s with 120 A

Rated data acc. to CSA

Institute (CSA)		Certificate No. (CSA)	200039-1815154
Rated voltage (Use group B / CSA)	300 V	Rated voltage (Use group D / CSA)	300 V
Rated current (Use group B / CSA)	18 A	Rated current (Use group D / CSA)	10 A
Wire cross-section, AWG, min.	AWG 24	Wire cross-section, AWG, max.	AWG 14
Reference to approval values	Specifications are maximum values, details - see approval certificate.		

Rated data acc. to UL 1059

Institute (cURus)		Certificate No. (cURus)	E60693
Rated voltage (Use group B / UL 1059)	300 V	Rated voltage (Use group D / UL 1059)	300 V
Rated current (Use group B / UL 1059)	15 A	Rated current (Use group D / UL 1059)	10 A
Wire cross-section, AWG, min.	AWG 24	Wire cross-section, AWG, max.	AWG 14
Reference to approval values	Specifications are maximum values, details - see approval certificate.		

Packing

Packaging	Box	VPE length	55 mm
VPE width	155 mm	VPE height	170 mm

Classifications

ETIM 6.0	EC002643	ETIM 7.0	EC002643
ETIM 8.0	EC002643	ECLASS 9.0	27-44-04-01
ECLASS 9.1	27-44-04-01	ECLASS 10.0	27-44-04-01
ECLASS 11.0	27-46-01-01	ECLASS 12.0	27-46-01-01

LM2H 5.08/30/90 3.5SN OR BX

Weidmüller Interface GmbH & Co. KG
 Klingenbergstraße 26
 D-32758 Detmold
 Germany

www.weidmueller.com

Technical data

Important note

IPC conformity	Conformity: The products are developed, manufactured and delivered according international recognized standards and norms and comply with the assured properties in the data sheet resp. fulfill decorative properties in accordance with IPC-A-610 "Class 2". Further claims on the products can be evaluated on request.
Notes	<ul style="list-style-type: none"> • Rated current related to rated cross-section & min. No. of poles. • Wire end ferrule without plastic collar to DIN 46228/1 • Wire end ferrule with plastic collar to DIN 46228/4 • P on drawing = pitch • Rated data refer only to the component itself. Clearance and creepage distances to other components are to be designed in accordance with the relevant application standards. • Long term storage of the product with average temperature of 50 °C and average humidity 70%, 36 months

Approvals

Approvals



ROHS	Conform
UL File Number Search	UL Website
Certificate No. (cURus)	E60693

Downloads

Approval/Certificate/Document of Conformity	Declaration of the Manufacturer
Engineering Data	CAD data – STEP
Engineering Data	WSCAD
Catalogues	Catalogues in PDF-format
Brochures	FL DRIVES EN FL ANALO.SIGN.CONV. EN MB DEVICE MANUF. EN FL DRIVES DE FL BUILDING SAFETY EN FL APPL LED LIGHTING EN FLIndustr.CONTROLS EN FL MACHINE SAFETY EN FL HEATING ELECTR EN FL APPL INVERTER EN FL_BASE_STATION_EN FL ELEVATOR EN FL POWER SUPPLY EN FL 72H SAMPLE SER EN PO OMNIMATE EN PO OMNIMATE EN

LM2H 5.08/30/90 3.5SN OR BX

Weidmüller Interface GmbH & Co. KG
 Klingenbergstraße 26
 D-32758 Detmold
 Germany

www.weidmueller.com

Drawings

Dimensional drawing

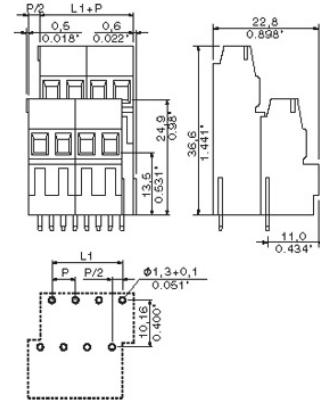

Graph

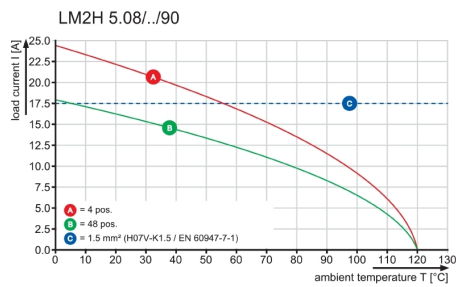

Technical Data 

Rev.

Material data

Insulation material type	PA 66/6(WEMID)
Insulation material colours	orange,black,green,gre
Insulation material flammability class	UL94
Insulation resistance	MOhm
Contact base material	>10 ⁸
Contact plating	Cu-alloy
	Tin-plated

System characteristic values

Pitch P	mm/inch	5.08 / 0.200
Number of rows		2
Dielectric strength (r.m.s withstand voltage)	kV	>2.5
Through resistance (typical)	mOhm	1.7
Operating temperature range	°C	-55...+120° 1)
Degree of protection acc. to VDE 0106		finger safe
Degree of protection acc. to DIN EN 60529		IP20
Conductor connection method		clamping yoke
Screw size		M2.5
Screw torque max. acc. to EN 60999	Nm	0.4 - 0.5
Screwdriver type		SD 0.6X3.5 / SDK PZ0
Solder pin length L	mm/inch	3.5 / 0.138
PCB hole diameter D (wave soldering)	mm/inch	1.3+0.10/0.051+0.004 2)
PCB hole diameter D (reflow soldering)	mm/inch	n.a. 3)
Resistance to soldering heat acc. to DIN IEC 60512-6	°C/sec	260/10 4)
Resistance to soldering heat acc. to EN 61760-1	°C/sec	n.a. 5)
Solderability classification acc. to EN 61760-1		n.a.
Solder connection type		wave soldering
Solder pin diameter d (max.)	mm/inch	1.24/0.049

Application notes

Coding possibility	yes/no	no
Joinable without loss of pitch	yes/no	yes
Manual assembly of modules	yes/no	yes
Max. number of poles	n	48

Conductor

Clamping range	mm ²	0.20-2.5
"e" solid H05(07) V-U	mm ²	0.20-2.5
"f" flexible H05(07) V-K	mm ²	0.20-1.5
"f" with ferrule acc. to DIN 46228/1	mm ²	0.25-1.5
... with plastic collar acc. to DIN 46228/4	mm ²	0.25-1.5
Conductor insulation stripping length	mm/inch	6.0
Conductor insulation diameter max.	mm/inch	n.a.
Two wire clamping range	mm ²	n.a.
Gauge to EN 60999 (a x b ; Ø)	mm	2.4x1.5 (A1); Ø1.9

IEC 664-1 / VDE0110 (4.97) rated data

Rated cross section acc. to EN 60999	mm ²	1.5
Rated current @ 20°C ambient (min. pole , max. wire)	A	17.5 6)
Rated current @ 40°C ambient (min. pole , max. wire)	A	17.5 6)

Overvoltage category / Pollution degree

Rated voltage	V	III/3	III/2	II/2
Rated impulse voltage	kV	250	320	630
		4.0	4.0	4.0

UL 1059 rated data  File No.: E60693

Rated voltage	V	B	C	D
Rated current	A	300	n.a.	300
AWG wire range (field wiring / factory wiring)		15	n.a.	10
		24-14		

CSA C22.2 rated data  File No.: LR12400

Rated voltage	V	B	C	D
Rated current	A	300	n.a.	300
AWG wire range (field wiring / factory wiring)		18	n.a.	10
		24-14		

Packaging

cardboard box

Downloads

www.weidmueller.de

- 1) Sum of ambient temperature and temperature rise
- 2) Recommendation for manual assembly
- 3) Recommendation for automatic assembly
- 4) Recommendation for wave soldering
- 5) Recommendation for reflow soldering
- 6) Referred to rated cross section and minimum pole number

n.a. = not applicable

Subject to technical changes

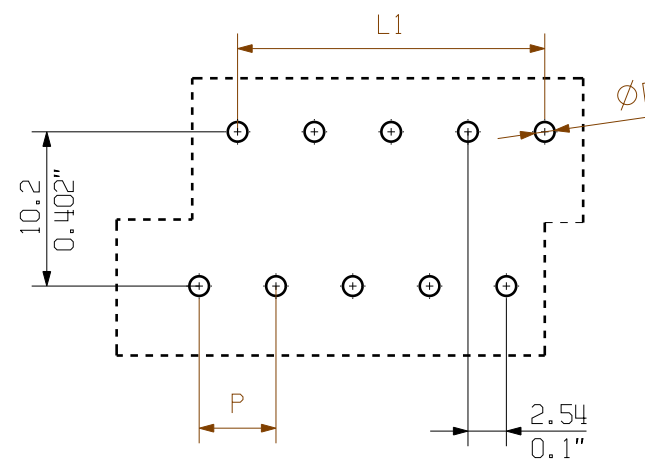

PCB LAYOUT

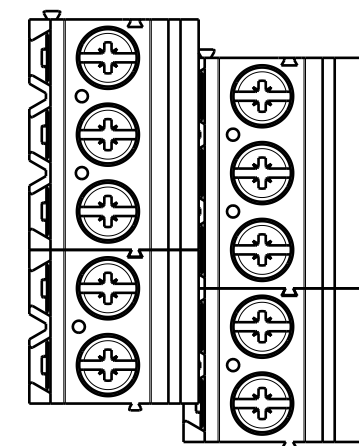
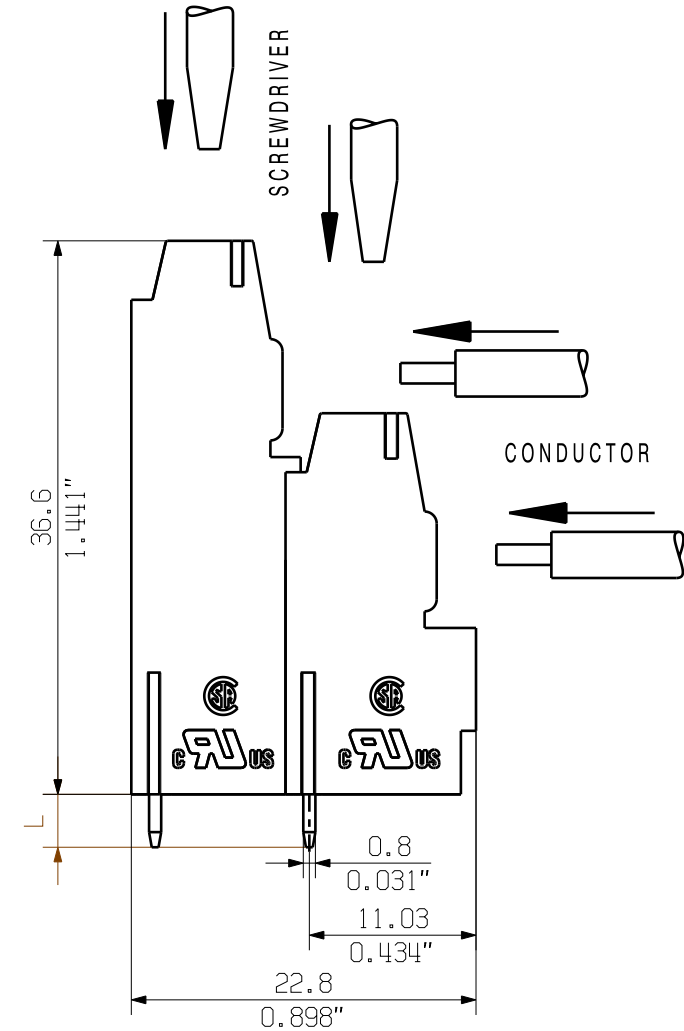

KUNDENZEICHUNG
CUSTOMER DRAWING

48	116.84	4.600
46	111.76	4.400
44	106.68	4.200
42	101.60	4.000
40	96.52	3.800
38	91.44	3.600
36	86.36	3.400
34	81.28	3.200
32	76.20	3.000
30	71.12	2.800
28	66.04	2.600
26	60.96	2.400
24	55.88	2.200
22	50.80	2.000
20	45.72	1.800
18	40.64	1.600
16	35.56	1.400
14	30.48	1.200
12	25.40	1.000
10	20.32	0.800
8	15.24	0.600
6	10.16	0.400
4	5.08	0.200
N	L1 [mm]	L1 [inch]

For the mounting of PCBs, it should be noted that the rated data stated here relates only to the PCB components alone. The necessary creepage and clearance paths must be observed in connection with the respective applicant in accordance to IEC 664 / VDE 0110. The current-carrying capacity and pitch tolerance is to be determined according to DIN IEC 326 part 3 very fine.

Weidmüller PCB components are tested to the DIN EN 61984 standard, and are valid for its field of application. Provided that the components are used to the intended purpose, all requirements with respect to the occurring of electrical, mechanical, thermic and corrosive stress will be satisfied.

SHOWN: LM2H 5.08/10

METRIC TOLERANCES
X. = ±0.3
X.X = ±0.1
X.XX = ±0.05

37682/5
21.08.07 SHI_S 01
MODIFICATION

Weidmüller 

CAT.NO.:
C 41738 
DRAWING NO. ISSUE NO.

	DATE	NAME
DRAWN	01.04.2005	XU_S
RESPONSIBLE		WANG_R
CHECKED	20.07.2007	LIU_ZH
APPROVED		DONG_H

LM2H 5.08/...
LEITERPLATTENKLEMME
PCB TERMINAL
PRODUCT FILE: LM2H 5.08 7065

WEITERGABE SOWIE VERVIELFÄLTIGUNG DIESES DOKUMENTS, VERWERTUNG UND MITTEILUNG SEINES INHALTS SIND VERBOTEN, SOWEIT NICHT AUSDRUECKLICH GESTATET. ZUWIDERHANDLUNGEN VERPFLICHTEN ZU SCHADENSERSATZ. ALLE RECHTE FUER DEN FALL DER PATENT-, GEBRAUCHSMUSTER- ODER GESCHMACKSMUSTERREINTRAGUNG VORBEHALTEN. THE REPRODUCTION, DISTRIBUTION AND UTILIZATION OF THIS DOCUMENT AS WELL AS THE COMMUNICATION OF ITS CONTENTS TO OTHERS WITHOUT EXPLICIT AUTHORIZATION IS PROHIBITED. OFFENDERS WILL BE HELD LIABLE FOR THE PAYMENT OF DAMAGES. ALL RIGHTS RESERVED IN THE EVENT OF A PATENT, UTILITY MODEL OR DESIGN.

Recommended wave soldering profiles

Weidmüller Interface GmbH & Co. KG
 Klängenbergstraße 16
 D-32758 Detmold
 Germany
 Fon: +49 5231 14-0
 Fax: +49 5231 14-292083
 www.weidmueller.com

Single Wave:



Double Wave:



Wave soldering profiles

Wired connection elements should be processed in accordance with the DIN EN 61760-1 standard. We have included two recommendations for practical wave soldering profiles, with which Weidmüller PCB terminals and connectors are qualified.

When choosing a suitable profile for your application, the following factors also need to be considered:

- PCB thickness
- Proportion of Cu in the layers
- Single/double-sided assembly
- Product range
- Heating and cooling rates

The single and double wave profiles each indicate the recommended operating range, including the maximum soldering temperature of 260°C. In practice, the maximum soldering temperature is quite often well below the above maximum profile.