

**SAI-8-F 5P 15M 0.5/1.0U****Weidmüller Interface GmbH & Co. KG**

Klingenbergstraße 26

D-32758 Detmold

Germany

www.weidmueller.com



M12 distributors are available in various versions. The 4, 6 or 8 M12 slots are in 4 or 5 pole design. The group outlet is designed as a fixed cable version, hood version for connection by the user, or with M23. Special versions are also available. For instance, there are 1-to-1 distributors for use with any connection types, or distributors approved for Ex Zone 1.

**General ordering data**

Version	Sensor-actuator passive distributor, M12, Fixed cable version, 15 m, Yes
Order No.	<a href="#">1784510000</a>
Type	SAI-8-F 5P 15M 0.5/1.0U
GTIN (EAN)	4032248190706
Qty.	1 pc(s).

Creation date March 16, 2023 4:57:59 PM CET

Catalogue status 03.03.2023 / We reserve the right to make technical changes.

## SAI-8-F 5P 15M 0.5/1.0U

Weidmüller Interface GmbH &amp; Co. KG

Klingenbergstraße 26

D-32758 Detmold

Germany

www.weidmueller.com

## Technical data

## Dimensions and weights

Height	25 mm	Height (inches)	0.984 inch
Net weight	2,548 g		

## Temperatures

Operating temperature	-20 - 80°C	Operating temperature, min.	-20 °C
Operating temperature, max.	80 °C		

## Connection data

Sheathing stripping length	100 mm	Distributor outlet	Fixed cable version
----------------------------	--------	--------------------	---------------------

## Electrical data

Rated voltage, min.	10 V	Rated voltage, max.	30 V
Test voltage	1 kV	Max. current-carrying capacity per slot	4 A
Total current	9 A	Current per signal	2 A
Electrical isolation available	No	Insulation strength	10 <sup>9</sup> Ω

## General technical data

Plug-in station coding	A	Protection degree	IP68
Number of poles	5	Number of contact sockets	8
Connection thread	M12	Pollution severity	3
Fire behaviour	V-0	Plugging cycles	≤ 50
LED	Yes	LED initiator	Yes
LED colour for indicating operation	green	LED colour for I/O function	yellow

## Material data

Housing main material	Pocan	Material of distributor	Plastic
Housing colour	grey, RAL 7032	Hood sealing material	Viton
Screw socket	Nickel-plated CuZn	Contact material	CuZn
Contact surface	Gold-plated	Contact carrier material	PBT (UL 94 V0)

## Technical data cable

Bending radius, min., moving	10 x cable diameter	Bending radius, min., stationary	5 x cable diameter
Colour coding	blue, brown, Green/yellow, yellow, grey, green, white, pink, red, black, violet, grey / pink, red / blue, white / green, brown / green, white / yellow, Yellow / brown, grey / brown	Number of poles	5
O.D.	12.3 mm	Sheathing colour	Deep black
Wire cross section (Print/Online)	16 x 0.5 mm <sup>2</sup> + 3 x 1.0 mm <sup>2</sup>	Cable length	15 m
Suitable for cable carriers	Yes	Armoured line	16 x 0,5 mm <sup>2</sup> + 3 x 1 mm <sup>2</sup> ;

## SAI-8-F 5P 15M 0.5/1.0U

**Weidmüller Interface GmbH & Co. KG**  
 Klingenbergstraße 26  
 D-32758 Detmold  
 Germany

www.weidmueller.com

# Technical data

### Classifications

ETIM 6.0	EC002585	ETIM 7.0	EC002585
ETIM 8.0	EC002585	ECLASS 9.0	27-44-01-08
ECLASS 9.1	27-44-01-08	ECLASS 10.0	27-44-01-08
ECLASS 11.0	27-44-01-08	ECLASS 12.0	27-44-01-08

### Environmental Product Compliance

REACH SVHC	Lead 7439-92-1
------------	----------------

### Approvals

Approvals



ROHS	Conform
UL File Number Search	UL Website
Certificate No. (cURus)	E141197

### Downloads

Engineering Data	<a href="#">CAD data – STEP</a>
Engineering Data	<a href="#">WSCAD</a>
Catalogues	<a href="#">Catalogues in PDF-format</a>
Brochures	<a href="#">FL FIELDWIRING EN</a> <a href="#">FL FIELDWIRING EN</a>

**SAI-8-F 5P 15M 0.5/1.0U**

**Weidmüller Interface GmbH & Co. KG**  
 Klingenbergstraße 26  
 D-32758 Detmold  
 Germany

www.weidmueller.com

**Drawings**

**Dimensioned drawing**

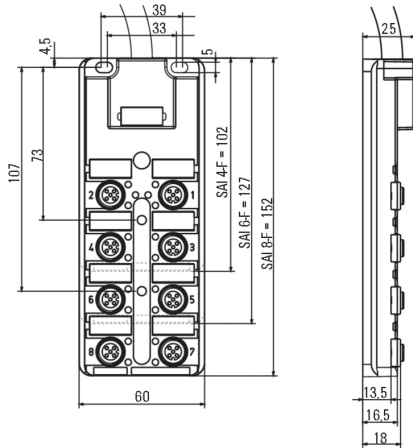

**Wiring diagram**

