

LUP 12.70/07/90 3.2SN GY BX

Weidmüller Interfaces GmbH & Co. KG

Postfach 3030

32760 Detmold

Tel. +49 5231 14-0

Fax. +49 5231 14-2083

info@weidmueller.com

www.weidmueller.com

Product image



Similar to illustration

This PCB terminal provides connections for 1000 V, 76 A and 16 mm² conductor cross-section with proven clamping yoke connection at 12.7 mm pitch, conductor outlet direction in 90° design.

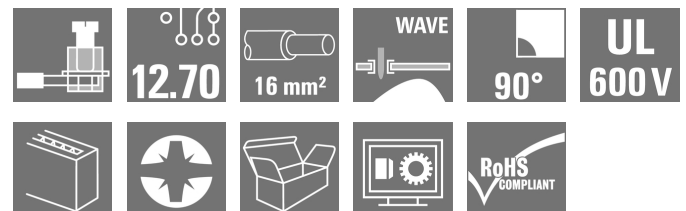

General ordering data

Version	Printed circuit board terminals, 12.70 mm, Number of poles: 7, 90°, Solder pin length (l): 3.2 mm, tinned, Pebble grey, Clamping yoke connection, Clamping range, max.: 16 mm ² , Box
Order No.	1839230000
Type	LUP 12.70/07/90 3.2SN GY BX
GTIN (EAN)	4032248349739
Qty.	20 pc(s).
Product data	IEC: 1000 V / 76 A / 0.5 - 16 mm ² UL: 600 V / 65 A / AWG 22 - AWG 6
Packaging	Box

LUP 12.70/07/90 3.2SN GY BX

Weidmüller Interfaces GmbH & Co. KG

Postfach 3030

32760 Detmold

Tel. +49 5231 14-0

Fax. +49 5231 14-2083

info@weidmueller.com

www.weidmueller.com

Technical data

Dimensions and weights

Depth	25.1 mm	Depth (inches)	0.988 inch
Height	34.7 mm	Height (inches)	1.366 inch
Height of lowest version	31.5 mm	Width	87.16 mm
Width (inches)	3.431 inch	Net weight	72.65 g

Temperatures

Operating temperature, min.	-50 °C	Operating temperature, max.	120 °C
-----------------------------	--------	-----------------------------	--------

System parameters

Product family	OMNIMATE Power - series LUP	Wire connection method	Clamping yoke connection
Mounting onto the PCB	THT solder connection	Conductor outlet direction	90°
Pitch in mm (P)	12.7 mm	Pitch in inches (P)	0.5 inch
Number of poles	7	Pin series quantity	1
Fitted by customer	Yes	Number of rows	1
Max. adjacent poles per row	12	Solder pin length (l)	3.2 mm
Solder pin dimensions	1.2 x 1.2 mm	Solder eyelet hole diameter (D)	1.6 mm
Solder eyelet hole diameter tolerance (D)	+ 0,1 mm	Number of solder pins per pole	2
Screwdriver blade	1.0 x 5.5, PZ 2	Screwdriver blade standard	DIN 5264
Tightening torque, min.	1.2 Nm	Tightening torque, max.	1.5 Nm
Clamping screw	M 4	Stripping length	12 mm
L1 in mm	76.2 mm	L1 in inches	3 inch
Touch-safe protection acc. to DIN VDE 0470	IP20 plugged/ IP10 unplugged	Touch-safe protection acc. to DIN VDE 57 106	Safe from finger touch
Protection degree	IP20	Volume resistance	0.50 mΩ

Material data

Insulating material	Wemid (PA)	Colour	Pebble grey
Colour chart (similar)	RAL 7032	Insulating material group	I
Comparative Tracking Index (CTI)	≥ 600	UL 94 flammability rating	V-0
Contact material	E-Cu	Contact surface	tinned
Layer structure of solder connection	1.5...3 µm Ni / 4...6 µm Sn matt	Storage temperature, min.	-40 °C
Storage temperature, max.	70 °C	Operating temperature, min.	-50 °C
Operating temperature, max.	120 °C	Temperature range, installation, min.	-25 °C
Temperature range, installation, max.	120 °C		

Conductors suitable for connection

Clamping range, min.	0.13 mm ²
Clamping range, max.	16 mm ²
Wire connection cross section AWG, min.	AWG 22
Wire connection cross section AWG, max.	AWG 6
Solid, min. H05(07) V-U	0.5 mm ²
Solid, max. H05(07) V-U	16 mm ²
Stranded, min. H07V-R	6 mm ²
Stranded, max. H07V-R	16 mm ²
Flexible, min. H05(07) V-K	0.5 mm ²
Flexible, max. H05(07) V-K	16 mm ²
w. plastic collar ferrule, DIN 46228 pt 4, 2.5 mm ² min.	

Creation date March 6, 2023 12:00:11 PM CET

LUP 12.70/07/90 3.2SN GY BX

Weidmüller Interfaces GmbH & Co. KG

Postfach 3030

32760 Detmold

Tel. +49 5231 14-0

Fax. +49 5231 14-2083

info@weidmueller.com

www.weidmueller.com

Technical data

w. plastic collar ferrule, DIN 46228 pt 4, 10 mm² max.

w. wire end ferrule, DIN 46228 pt 1, 2.5 mm² min.

w. wire end ferrule, DIN 46228 pt 1, 10 mm² max.

Plug gauge in accordance with EN 60999 a x b; ø 5.4 mm x 5.1 mm; 5.3 mm

Clampable conductor	Cross-section for conductor connection	Type	fine-wired	
		nominal	2.5 mm ²	
	wire end ferrule	Stripping length	nominal	12 mm
		Recommended wire-end ferrule	H2.5/12	
		Stripping length	nominal	14 mm
		Recommended wire-end ferrule	H2.5/19D BL	
	Cross-section for conductor connection	Type	fine-wired	
		nominal	4 mm ²	
	wire end ferrule	Stripping length	nominal	12 mm
		Recommended wire-end ferrule	H4.0/12	
		Stripping length	nominal	14 mm
		Recommended wire-end ferrule	H4.0/20D GR	
	Cross-section for conductor connection	Type	fine-wired	
		nominal	6 mm ²	
	wire end ferrule	Stripping length	nominal	12 mm
		Recommended wire-end ferrule	H6.0/12	
Stripping length		nominal	14 mm	
Recommended wire-end ferrule		H6.0/20 SW		
Cross-section for conductor connection	Type	fine-wired		
	nominal	10 mm ²		
wire end ferrule	Stripping length	nominal	15 mm	
	Recommended wire-end ferrule	H10.0/22 EB		
	Stripping length	nominal	12 mm	
	Recommended wire-end ferrule	H10.0/12		

Reference text Length of ferrules is to be chosen depending on the product and the rated voltage., The outside diameter of the plastic collar should not be larger than the pitch (P)

Rated data acc. to IEC

tested acc. to standard	IEC 60664-1, IEC 61984	Rated current, min. number of poles (Tu=20°C)	76 A
Rated current, max. number of poles (Tu=20°C)	74 A	Rated current, min. number of poles (Tu=40°C)	76 A
Rated current, max. number of poles (Tu=40°C)	64 A	Rated voltage for surge voltage class / pollution degree II/2	1,000 V
Rated voltage for surge voltage class / pollution degree III/2	1,000 V	Rated voltage for surge voltage class / pollution degree III/3	1,000 V
Rated impulse voltage for surge voltage class/ pollution degree II/2	6 kV	Rated impulse voltage for surge voltage class/ pollution degree III/2	8 kV
Rated impulse voltage for surge voltage class/ contamination degree III/3	8 kV	Short-time withstand current resistance	1 x 1s with 700 A

LUP 12.70/07/90 3.2SN GY BX

Weidmüller Interfaces GmbH & Co. KG

Postfach 3030

32760 Detmold

Tel. +49 5231 14-0

Fax. +49 5231 14-2083

info@weidmueller.com

www.weidmueller.com

200039-1198743

Technical data

Rated data acc. to CSA

Institute (CSA)



Certificate No. (CSA)

www.weidmueller.com

Rated voltage (Use group B / CSA) 600 V

Rated current (Use group B / CSA) 65 A

Wire cross-section, AWG, min. AWG 22

Reference to approval values

Specifications are maximum values, details - see approval certificate.

Rated voltage (Use group C / CSA) 600 V

Rated current (Use group C / CSA) 65 A

Wire cross-section, AWG, max. AWG 6

Rated data acc. to UL 1059

Institute (cURus)



Certificate No. (cURus)

E60693

Rated voltage (Use group B / UL 1059) 600 V

Rated current (Use group B / UL 1059) 65 A

Wire cross-section, AWG, min. AWG 22

Reference to approval values

Specifications are maximum values, details - see approval certificate.

Rated voltage (Use group C / UL 1059) 600 V

Rated current (Use group C / UL 1059) 65 A

Wire cross-section, AWG, max. AWG 6

Packing

Packaging	Box	VPE length	309 mm
VPE width	96 mm	VPE height	71 mm

Classifications

ETIM 6.0	EC002643	ETIM 7.0	EC002643
ETIM 8.0	EC002643	ECLASS 9.0	27-44-04-01
ECLASS 9.1	27-44-04-01	ECLASS 10.0	27-44-04-01
ECLASS 11.0	27-46-01-01	ECLASS 12.0	27-46-01-01

LUP 12.70/07/90 3.2SN GY BX

Weidmüller Interfaces GmbH & Co. KG

Postfach 3030

32760 Detmold

Tel. +49 5231 14-0

Fax. +49 5231 14-2083

info@weidmueller.com

www.weidmueller.com

Technical data

Important note

IPC conformity	Conformity: The products are developed, manufactured and delivered according international recognized standards and norms and comply with the assured properties in the data sheet resp. fulfill decorative properties in accordance with IPC-A-610 "Class 2". Further claims on the products can be evaluated on request.
Notes	<ul style="list-style-type: none"> • Additional variants on request • Rated current related to rated cross-section & min. No. of poles. • Wire end ferrule without plastic collar to DIN 46228/1 • Wire end ferrule with plastic collar to DIN 46228/4 • The data given under CSA relates to a cUL approval - E60693 • P on drawing = pitch • Rated data refer only to the component itself. Clearance and creepage distances to other components are to be designed in accordance with the relevant application standards. • Long term storage of the product with average temperature of 50 °C and average humidity 70%, 36 months

Approvals

Approvals



ROHS	Conform
UL File Number Search	UL Website
Certificate No. (cURus)	E60693

Downloads

Approval/Certificate/Document of Conformity	Declaration of the Manufacturer
Engineering Data	CAD data – STEP
Engineering Data	WSCAD
Product Change Notification	20220201 Visual change OMNIMATE® Power PCB terminal blocks and connectors 20220201 Visuelle Änderung OMNIMATE® Power Leiterplattenklemmen und -steckverbinder
User Documentation	QR-Code product handling video
Catalogues	Catalogues in PDF-format
Brochures	FL DRIVES EN MB DEVICE MANUF. EN FL DRIVES DE FL APPL. INVERTER EN FL_BASE_STATION_EN FL ELEVATOR EN FL POWER SUPPLY EN FL 72H SAMPLE SER EN PO OMNIMATE EN

LUP 12.70/07/90 3.2SN GY BX

Weidmüller Interfaces GmbH & Co. KG

Postfach 3030

32760 Detmold

Tel. +49 5231 14-0

Fax. +49 5231 14-2083

Drawings

Dimensional drawing info@weidmueller.com

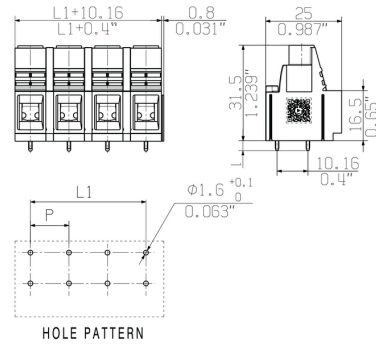

Graph

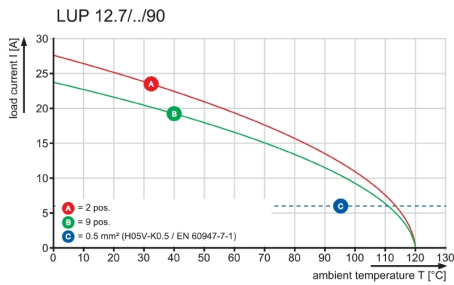

Graph

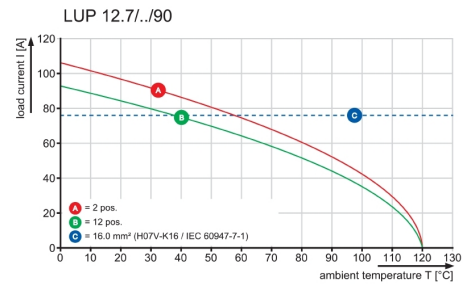

PS 2.0 / ORDER NO.
031000 0000

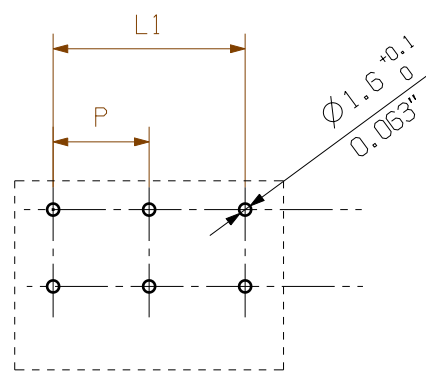
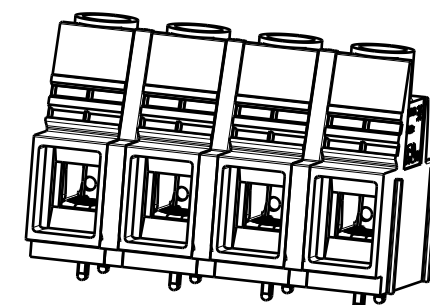
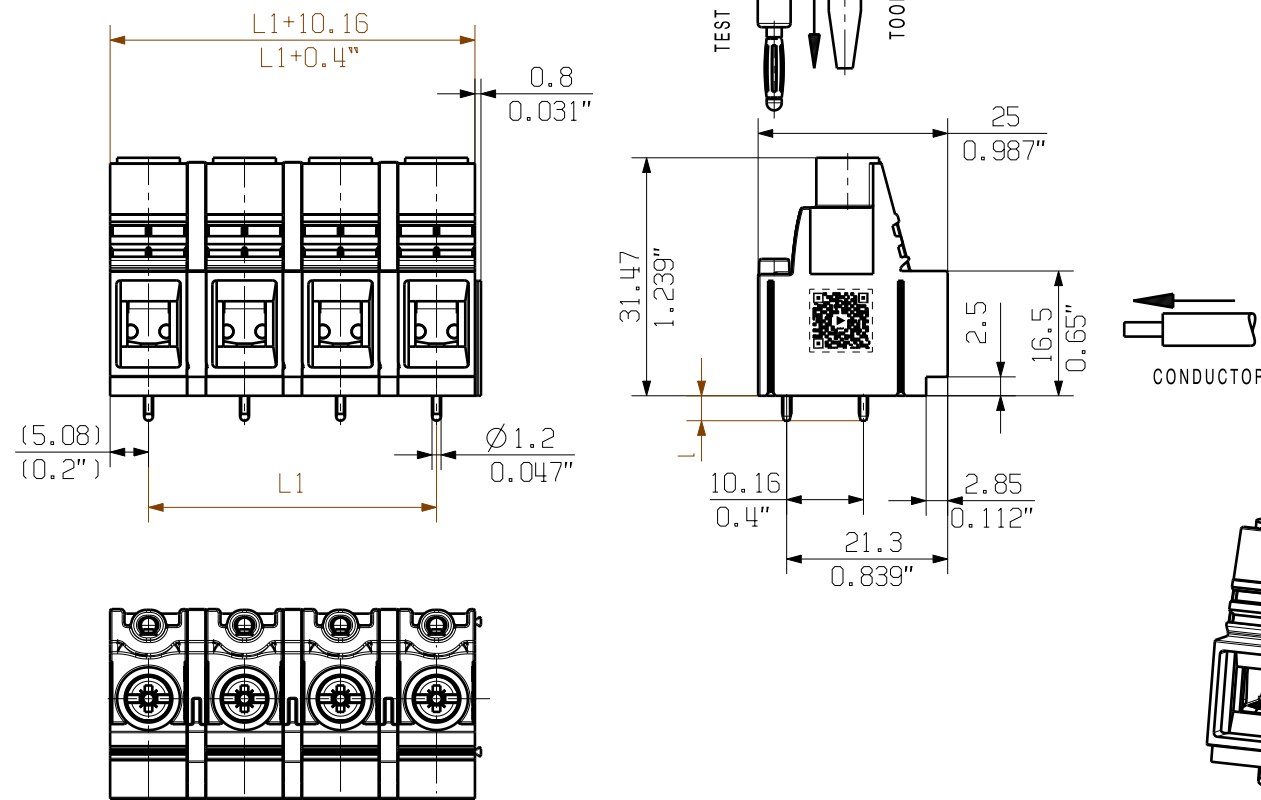

HOLE PATTERN (BLOCK)

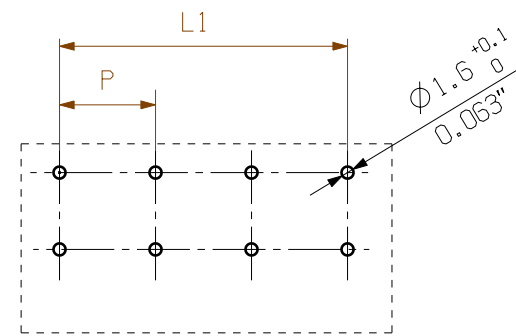

HOLE PATTERN

n=NO OF POLES
 P= PITCH=12.70
 l= STIFTLAENGE/ 5.0mm/0.197"
 PIN LENGTH 3.2mm/0.126"
 SHOWN: LUP 12.70/02/90...SO (BLOCK)
 LUP 12.70/03/90...SO (BLOCK)
 LUP 12.7/04/90... (SINGLE POL)

For the mounting of PCBs, it should be noted that the rated data given in the catalogue relates only to the connection elements. The necessary creepage and clearance paths must be observed in connection with the respective applicant in accordance to VDE 0110. The current-carrying capacity and pitch tolerance is to be determined according to DIN IEC 326 part 3 very fine.

Weidmüller connectors are tested to the DIN VDE 0627 standard, and are valid for its field of application. Provided that the connectors are used to the intended purpose, all requirements with respect to the occurring of electrical, mechanical, thermic and corrosive stress will be satisfied.

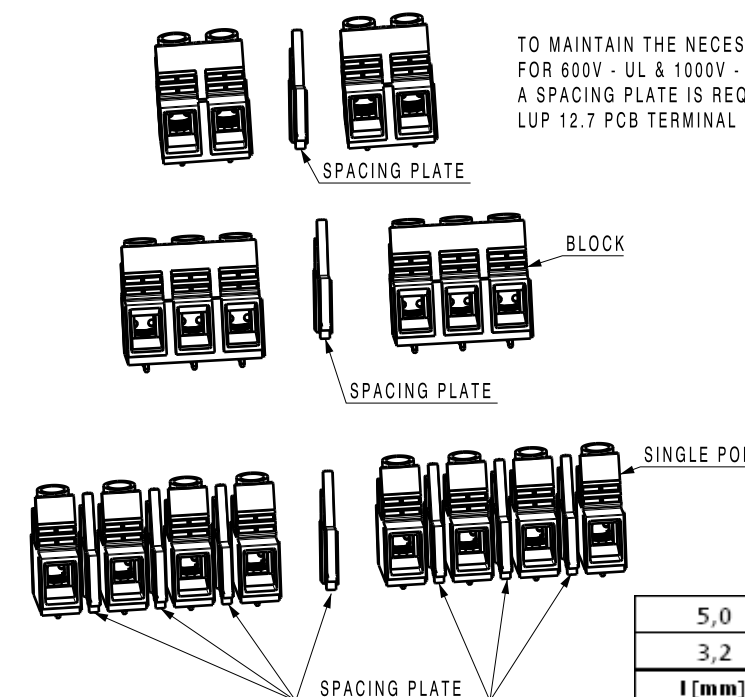

TO MAINTAIN THE NECESSARY VOLTAGE DISTANCES FOR 600V - UL & 1000V - IEC, A SPACING PLATE IS REQUIRED BETWEEN ASSEMBLED LUP 12.7 PCB TERMINAL BLOCKS

12	139,70	5,500	
11	127,00	5,000	
10	114,30	4,500	
9	101,60	4,000	
8	88,90	3,500	
7	76,20	3,000	
6	63,50	2,500	
5	50,80	2,000	
4	38,10	1,500	
5,0	3	25,40	1,000
3,2	2	12,70	0,500
l [mm]	n	L1 [mm]	L1 [inch]

GENERAL TOLERANCE:
DIN ISO 2768-mK

102479	Prim PLM Part No.: 411688	Prim ERP Part No.: 1160810000
RoHS COMPLIANT	First Issue Date 03.03.2018	Modification
Scale: 2:1	Size: A3	Drawings Assembly
Drawn 03.03.2018 Administrator	Date 03.03.2018 Name Administrator	Responsible Amann, Alexander
Approved	Product file: 7233 LUP 10.16/12.7	

Weidmüller

34163

Drawing no. 34163 Issue no. 10

Sheet 02 of 02 sheets

LUP12.70/././90

not released

The reproduction, distribution and utilization of this document as well as the communication of its contents to others without explicit authorization is prohibited. Offenders will be held liable for the payment of damages. Weidmüller exclusively reserves the right to file for patents, utility models or designs.

© Weidmüller Interface GmbH & Co. KG

Recommended wave soldering profiles

Weidmüller Interface GmbH & Co. KG
 Klängenbergstraße 16
 D-32758 Detmold
 Germany
 Fon: +49 5231 14-0
 Fax: +49 5231 14-292083
 www.weidmueller.com

Single Wave:



Double Wave:



Wave soldering profiles

Wired connection elements should be processed in accordance with the DIN EN 61760-1 standard. We have included two recommendations for practical wave soldering profiles, with which Weidmüller PCB terminals and connectors are qualified.

When choosing a suitable profile for your application, the following factors also need to be considered:

- PCB thickness
- Proportion of Cu in the layers
- Single/double-sided assembly
- Product range
- Heating and cooling rates

The single and double wave profiles each indicate the recommended operating range, including the maximum soldering temperature of 260°C. In practice, the maximum soldering temperature is quite often well below the above maximum profile.