

LUP 12.70/05/90 5.0SN BK BX

Weidmüller Interface GmbH & Co. KG
 Klingenbergstraße 26
 D-32758 Detmold
 Germany

www.weidmueller.com

Product image

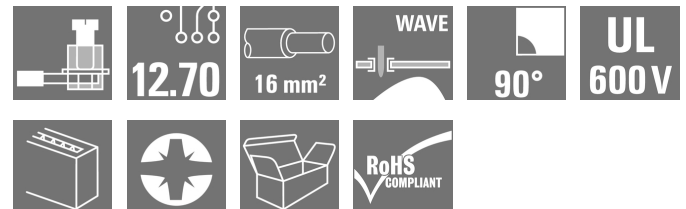

Similar to illustration

This PCB terminal provides connections for 1000 V, 76 A and 16 mm² conductor cross-section with proven clamping yoke connection at 12.7 mm pitch, conductor outlet direction in 90° design.

General ordering data

| | |
|--------------|---|
| Version | Printed circuit board terminals, 12.70 mm, Number of poles: 5, 90°, Solder pin length (l): 5 mm, tinned, black, Clamping yoke connection, Clamping range, max. : 16 mm ² , Box |
| Order No. | 2014420000 |
| Type | LUP 12.70/05/90 5.0SN BK BX |
| GTIN (EAN) | 4050118399776 |
| Qty. | 20 pc(s). |
| Product data | IEC: 1000 V / 76 A / 0.5 - 16 mm ² UL: 600 V / 65 A / AWG 22 - AWG 6 |
| Packaging | Box |

Creation date March 9, 2023 7:05:18 PM CET

LUP 12.70/05/90 5.0SN BK BX

Weidmüller Interface GmbH & Co. KG

Klingenbergstraße 26

D-32758 Detmold

Germany

www.weidmueller.com

Technical data

Dimensions and weights

| | | | |
|--------------------------|------------|-----------------|------------|
| Depth | 25.1 mm | Depth (inches) | 0.988 inch |
| Height | 36.5 mm | Height (inches) | 1.437 inch |
| Height of lowest version | 31.5 mm | Width | 61.76 mm |
| Width (inches) | 2.431 inch | Net weight | 50.6 g |

Temperatures

| | | | |
|-----------------------------|--------|-----------------------------|--------|
| Operating temperature, min. | -50 °C | Operating temperature, max. | 120 °C |
|-----------------------------|--------|-----------------------------|--------|

System parameters

| | | | |
|--|------------------------------|--|--------------------------|
| Product family | OMNIMATE Power - series LUP | Wire connection method | Clamping yoke connection |
| Mounting onto the PCB | THT solder connection | Conductor outlet direction | 90° |
| Pitch in mm (P) | 12.7 mm | Pitch in inches (P) | 0.5 inch |
| Number of poles | 5 | Pin series quantity | 1 |
| Fitted by customer | Yes | Number of rows | 1 |
| Max. adjacent poles per row | 12 | Solder pin length (l) | 5 mm |
| Solder pin dimensions | 1.2 x 1.2 mm | Solder eyelet hole diameter (D) | 1.6 mm |
| Solder eyelet hole diameter tolerance (D)+ | 0,1 mm | Number of solder pins per pole | 2 |
| Screwdriver blade | 1.0 x 5.5, PZ 2 | Screwdriver blade standard | DIN 5264 |
| Tightening torque, min. | 1.2 Nm | Tightening torque, max. | 1.5 Nm |
| Clamping screw | M 4 | Stripping length | 12 mm |
| L1 in mm | 50.8 mm | L1 in inches | 2 inch |
| Touch-safe protection acc. to DIN VDE 0470 | IP20 plugged/ IP10 unplugged | Touch-safe protection acc. to DIN VDE 57 106 | Safe from finger touch |
| Protection degree | IP20 | Volume resistance | 0.50 mΩ |

Material data

| | | | |
|---------------------------------------|----------------------------------|---------------------------------------|--------|
| Insulating material | Wemid (PA) | Colour | black |
| Colour chart (similar) | RAL 9011 | Insulating material group | I |
| Comparative Tracking Index (CTI) | ≥ 600 | UL 94 flammability rating | V-0 |
| Contact material | E-Cu | Contact surface | tinned |
| Layer structure of solder connection | 1.5...3 μm Ni / 4...6 μm Sn matt | Storage temperature, min. | -40 °C |
| Storage temperature, max. | 70 °C | Operating temperature, min. | -50 °C |
| Operating temperature, max. | 120 °C | Temperature range, installation, min. | -25 °C |
| Temperature range, installation, max. | 120 °C | | |

Conductors suitable for connection

| | |
|---|----------------------|
| Clamping range, min. | 0.13 mm ² |
| Clamping range, max. | 16 mm ² |
| Wire connection cross section AWG, min. | AWG 22 |
| Wire connection cross section AWG, max. | AWG 6 |
| Solid, min. H05(07) V-U | 0.5 mm ² |
| Solid, max. H05(07) V-U | 16 mm ² |
| Stranded, min. H07V-R | 6 mm ² |
| Stranded, max. H07V-R | 16 mm ² |
| Flexible, min. H05(07) V-K | 0.5 mm ² |
| Flexible, max. H05(07) V-K | 16 mm ² |
| w. plastic collar ferrule, DIN 46228 pt 4, 2.5 mm ² min. | |

Creation date March 9, 2023 7:05:18 PM CET

LUP 12.70/05/90 5.0SN BK BX

Weidmüller Interface GmbH & Co. KG
 Klingenbergstraße 26
 D-32758 Detmold
 Germany

www.weidmueller.com

Technical data

w. plastic collar ferrule, DIN 46228 pt 4, 10 mm² max.

w. wire end ferrule, DIN 46228 pt 1, 2.5 mm² min.

w. wire end ferrule, DIN 46228 pt 1, 10 mm² max.

Plug gauge in accordance with EN 60999 a x b; ø 5.4 mm x 5.1 mm; 5.3 mm

| Clampable conductor | Cross-section for conductor connection | Type | fine-wired |
|--|--|------------------------------|-----------------------------|
| | | nominal | 2.5 mm ² |
| wire end ferrule | Stripping length | nominal | 12 mm |
| | | Recommended wire-end ferrule | H2.5/12 |
| | Stripping length | nominal | 14 mm |
| | | Recommended wire-end ferrule | H2.5/19D BL |
| Cross-section for conductor connection | Type | fine-wired | |
| | nominal | 4 mm ² | |
| wire end ferrule | Stripping length | nominal | 12 mm |
| | | Recommended wire-end ferrule | H4.0/12 |
| | Stripping length | nominal | 14 mm |
| | | Recommended wire-end ferrule | H4.0/20D GR |
| Cross-section for conductor connection | Type | fine-wired | |
| | nominal | 6 mm ² | |
| wire end ferrule | Stripping length | nominal | 12 mm |
| | | Recommended wire-end ferrule | H6.0/12 |
| | Stripping length | nominal | 14 mm |
| | | Recommended wire-end ferrule | H6.0/20 SW |
| Cross-section for conductor connection | Type | fine-wired | |
| | nominal | 10 mm ² | |
| wire end ferrule | Stripping length | nominal | 15 mm |
| | | Recommended wire-end ferrule | H10.0/22 EB |
| | Stripping length | nominal | 12 mm |
| | | Recommended wire-end ferrule | H10.0/12 |

Reference text Length of ferrules is to be chosen depending on the product and the rated voltage., The outside diameter of the plastic collar should not be larger than the pitch (P)

Rated data acc. to IEC

| tested acc. to standard | | Rated current, min. number of poles (Tu=20°C) | |
|---|------------------------|---|-------------------|
| | IEC 60664-1, IEC 61984 | | 76 A |
| Rated current, max. number of poles (Tu=20°C) | 74 A | Rated current, min. number of poles (Tu=40°C) | 76 A |
| Rated current, max. number of poles (Tu=40°C) | 64 A | Rated voltage for surge voltage class / pollution degree II/2 | 1,000 V |
| Rated voltage for surge voltage class / pollution degree III/2 | 1,000 V | Rated voltage for surge voltage class / pollution degree III/3 | 1,000 V |
| Rated impulse voltage for surge voltage class/ pollution degree II/2 | 6 kV | Rated impulse voltage for surge voltage class/ pollution degree III/2 | 8 kV |
| Rated impulse voltage for surge voltage class/ contamination degree III/3 | 8 kV | Short-time withstand current resistance | 1 x 1s with 700 A |

LUP 12.70/05/90 5.0SN BK BX

Weidmüller Interface GmbH & Co. KG
Klingenbergstraße 26
D-32758 Detmold
Germany

www.weidmueller.com

Technical data

Rated data acc. to CSA

| | | | |
|-----------------------------------|--------|-----------------------------------|-------|
| Rated voltage (Use group B / CSA) | 600 V | Rated voltage (Use group C / CSA) | 600 V |
| Rated current (Use group B / CSA) | 65 A | Rated current (Use group C / CSA) | 65 A |
| Wire cross-section, AWG, min. | AWG 22 | Wire cross-section, AWG, max. | AWG 6 |

Rated data acc. to UL 1059

| | | | |
|---------------------------------------|---|---------------------------------------|--------|
| Institute (cURus) |  | Certificate No. (cURus) | E60693 |
| Rated voltage (Use group B / UL 1059) | 600 V | Rated voltage (Use group C / UL 1059) | 600 V |
| Rated current (Use group B / UL 1059) | 65 A | Rated current (Use group C / UL 1059) | 65 A |
| Wire cross-section, AWG, min. | AWG 22 | Wire cross-section, AWG, max. | AWG 6 |
| Reference to approval values | Specifications are maximum values, details - see approval certificate. | | |

Packing

| | | | |
|-----------|--------|------------|--------|
| Packaging | Box | VPE length | 145 mm |
| VPE width | 133 mm | VPE height | 78 mm |

Classifications

| | | | |
|-------------|-------------|-------------|-------------|
| ETIM 6.0 | EC002643 | ETIM 7.0 | EC002643 |
| ETIM 8.0 | EC002643 | ECLASS 9.0 | 27-44-04-01 |
| ECLASS 9.1 | 27-44-04-01 | ECLASS 10.0 | 27-44-04-01 |
| ECLASS 11.0 | 27-46-01-01 | ECLASS 12.0 | 27-46-01-01 |

Important note

| | |
|----------------|--|
| IPC conformity | Conformity: The products are developed, manufactured and delivered according international recognized standards and norms and comply with the assured properties in the data sheet resp. fulfill decorative properties in accordance with IPC-A-610 "Class 2". Further claims on the products can be evaluated on request. |
| Notes | <ul style="list-style-type: none"> • Additional variants on request • Rated current related to rated cross-section & min. No. of poles. • Wire end ferrule without plastic collar to DIN 46228/1 • Wire end ferrule with plastic collar to DIN 46228/4 • The data given under CSA relates to a cUL approval - E60693 • P on drawing = pitch • Rated data refer only to the component itself. Clearance and creepage distances to other components are to be designed in accordance with the relevant application standards. • Long term storage of the product with average temperature of 50 °C and average humidity 70%, 36 months |

Data sheet

LUP 12.70/05/90 5.0SN BK BX

Weidmüller Interface GmbH & Co. KG
 Klingenbergstraße 26
 D-32758 Detmold
 Germany

www.weidmueller.com

Technical data

Approvals

Approvals



| | |
|-------------------------|------------|
| ROHS | Conform |
| UL File Number Search | UL Website |
| Certificate No. (cURus) | E60693 |

Downloads

| | |
|---|--|
| Approval/Certificate/Document of Conformity | Declaration of the Manufacturer |
| Engineering Data | CAD data – STEP |
| Product Change Notification | 20220201 Visual change OMNIMATE® Power PCB terminal blocks and connectors 20220201 Visuelle Änderung OMNIMATE® Power Leiterplattenklemmen und -steckverbinder |
| User Documentation | QR-Code product handling video |
| Catalogues | Catalogues in PDF-format |
| Brochures | FL DRIVES EN MB DEVICE MANUF. EN FL DRIVES DE FL APPL_INVERTER EN FL_BASE_STATION EN FL ELEVATOR EN FL POWER SUPPLY EN FL 72H SAMPLE SER EN PO OMNIMATE EN |

LUP 12.70/05/90 5.0SN BK BX

Weidmüller Interface GmbH & Co. KG
 Klängenbergstraße 26
 D-32758 Detmold
 Germany

www.weidmueller.com

Drawings

Dimensional drawing

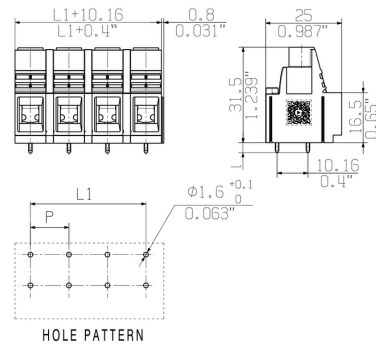

Graph

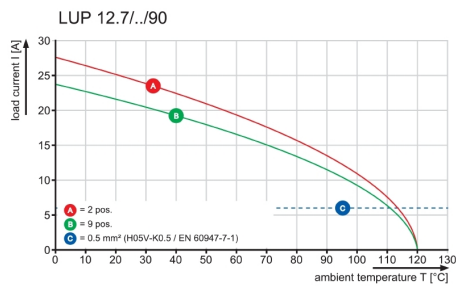

Graph

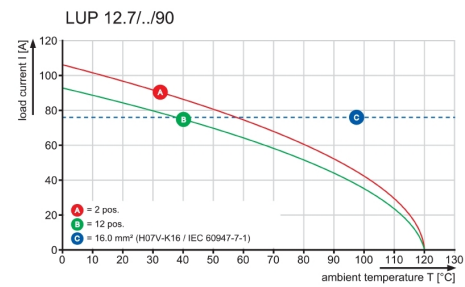

PS 2.0 / ORDER NO.
031000 0000

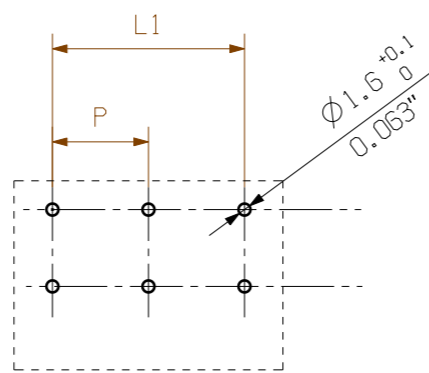
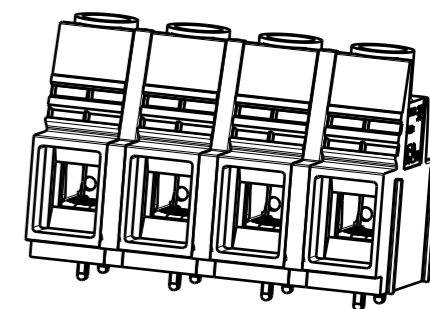
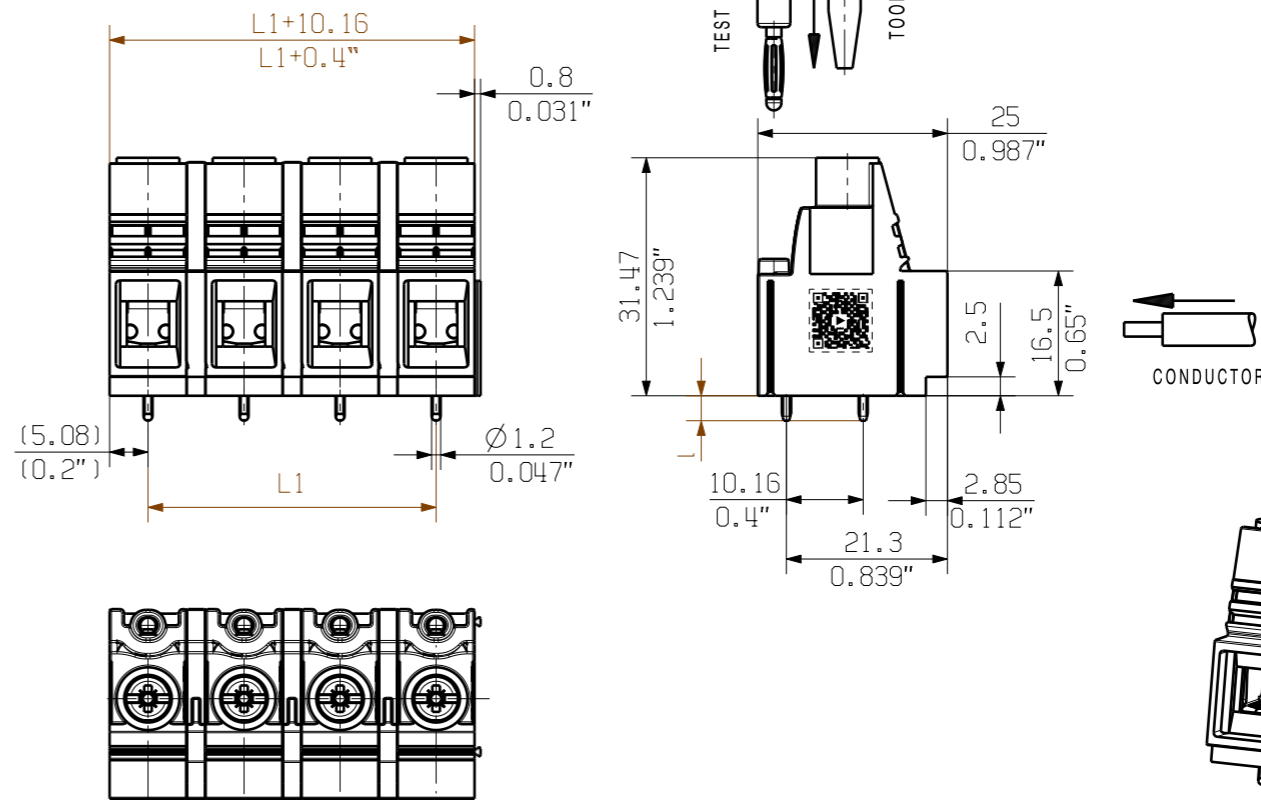

HOLE PATTERN (BLOCK)

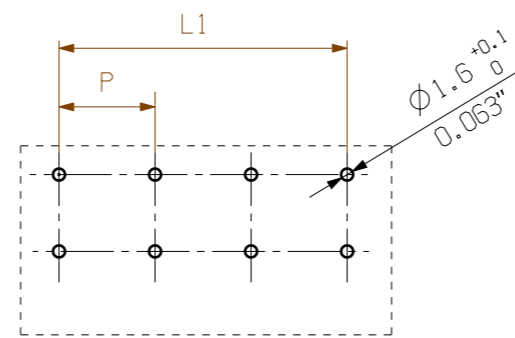

HOLE PATTERN

n=NO OF POLES
 P= PITCH=12.70
 l= STIFTLÄNGE/ 5.0mm/0.197"
 PIN LENGTH 3.2mm/0.126"
 SHOWN: LUP 12.70/02/90...SO (BLOCK)
 LUP 12.70/03/90...SO (BLOCK)
 LUP 12.7/04/90... (SINGLE POL)

For the mounting of PCBs, it should be noted that the rated data given in the catalogue relates only to the connection elements. The necessary creepage and clearance paths must be observed in connection with the respective applicant in accordance to VDE 0110. The current-carrying capacity and pitch tolerance is to be determined according to DIN IEC 326 part 3 very fine.

Weidmüller connectors are tested to the DIN VDE 0627 standard, and are valid for its field of application. Provided that the connectors are used to the intended purpose, all requirements with respect to the occurring of electrical, mechanical, thermic and corrosive stress will be satisfied.

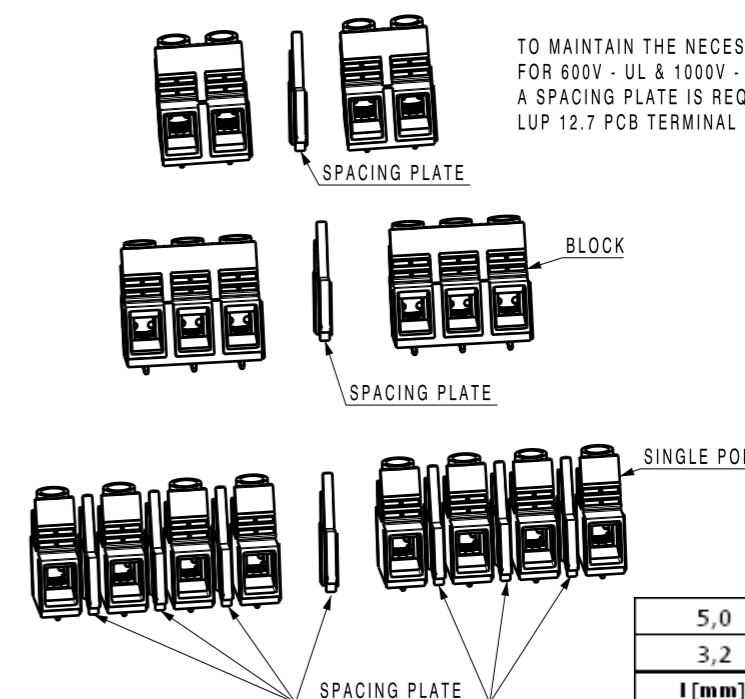

TO MAINTAIN THE NECESSARY VOLTAGE DISTANCES FOR 600V - UL & 1000V - IEC, A SPACING PLATE IS REQUIRED BETWEEN ASSEMBLED LUP 12.7 PCB TERMINAL BLOCKS

| | | |
|--------|--------|-------------------|
| 12 | 139,70 | 5,500 |
| 11 | 127,00 | 5,000 |
| 10 | 114,30 | 4,500 |
| 9 | 101,60 | 4,000 |
| 8 | 88,90 | 3,500 |
| 7 | 76,20 | 3,000 |
| 6 | 63,50 | 2,500 |
| 5 | 50,80 | 2,000 |
| 4 | 38,10 | 1,500 |
| 3 | 25,40 | 1,000 |
| 2 | 12,70 | 0,500 |
| l [mm] | n | L1 [mm] L1 [inch] |

GENERAL TOLERANCE:
DIN ISO 2768-mK

| | | |
|--------------------------------------|---|---------------------------------|
| 102479 | Prim PLM Part No.: 411688 | Prim ERP Part No.: 1160810000 |
| RoHS COMPLIANT | First Issue Date 03.03.2018 | Modification |
| Scale: 2:1 | Size: A3 | Drawings Assembly |
| Drawn 03.03.2018 Administrator | Date 03.03.2018 Name Administrator | Responsible Amann, Alexander |
| Approved | Product file: 7233 LUP 10.16/12.7 | |
| Weidmüller | | 34163 |
| Sheet 02 of 02 sheets | | Issue no. 10 |
| LUP12.70/././90 | | not released |

Recommended wave soldering profiles

Weidmüller Interface GmbH & Co. KG
 Klängenbergstraße 16
 D-32758 Detmold
 Germany
 Fon: +49 5231 14-0
 Fax: +49 5231 14-292083
 www.weidmueller.com

Single Wave:



Double Wave:



Wave soldering profiles

Wired connection elements should be processed in accordance with the DIN EN 61760-1 standard. We have included two recommendations for practical wave soldering profiles, with which Weidmüller PCB terminals and connectors are qualified.

When choosing a suitable profile for your application, the following factors also need to be considered:

- PCB thickness
- Proportion of Cu in the layers
- Single/double-sided assembly
- Product range
- Heating and cooling rates

The single and double wave profiles each indicate the recommended operating range, including the maximum soldering temperature of 260°C. In practice, the maximum soldering temperature is quite often well below the above maximum profile.