

## LUP 12.70/06/90 5.0SN BK BX

**Weidmüller Interface GmbH & Co. KG**  
 Klingenbergstraße 26  
 D-32758 Detmold  
 Germany

www.weidmueller.com

### Product image

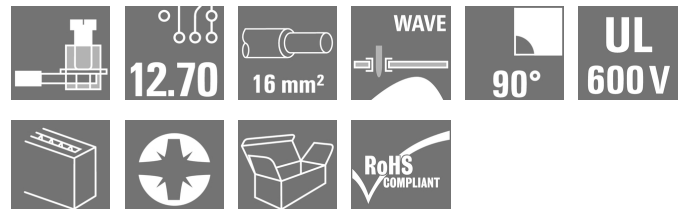

Similar to illustration

This PCB terminal provides connections for 1000 V, 76 A and 16 mm<sup>2</sup> conductor cross-section with proven clamping yoke connection at 12.7 mm pitch, conductor outlet direction in 90° design.

### General ordering data

Version	Printed circuit board terminals, 12.70 mm, Number of poles: 6, 90°, Solder pin length (l): 5 mm, tinned, black, Clamping yoke connection, Clamping range, max. : 16 mm <sup>2</sup> , Box
Order No.	<a href="#">2014590000</a>
Type	LUP 12.70/06/90 5.0SN BK BX
GTIN (EAN)	4050118399066
Qty.	20 pc(s).
Product data	IEC: 1000 V / 76 A / 0.5 - 16 mm <sup>2</sup> UL: 600 V / 65 A / AWG 22 - AWG 6
Packaging	Box

Creation date March 9, 2023 7:05:28 PM CET

## LUP 12.70/06/90 5.0SN BK BX

Weidmüller Interface GmbH &amp; Co. KG

Klingenbergstraße 26

D-32758 Detmold

Germany

www.weidmueller.com

## Technical data

## Dimensions and weights

Depth	25.1 mm	Depth (inches)	0.988 inch
Height	36.5 mm	Height (inches)	1.437 inch
Height of lowest version	31.5 mm	Width	74.46 mm
Width (inches)	2.931 inch	Net weight	60.92 g

## Temperatures

Operating temperature, min.	-50 °C	Operating temperature, max.	120 °C
-----------------------------	--------	-----------------------------	--------

## System parameters

Product family	OMNIMATE Power - series LUP	Wire connection method	Clamping yoke connection
Mounting onto the PCB	THT solder connection	Conductor outlet direction	90°
Pitch in mm (P)	12.7 mm	Pitch in inches (P)	0.5 inch
Number of poles	6	Pin series quantity	1
Fitted by customer	Yes	Number of rows	1
Max. adjacent poles per row	12	Solder pin length (l)	5 mm
Solder pin dimensions	1.2 x 1.2 mm	Solder eyelet hole diameter (D)	1.6 mm
Solder eyelet hole diameter tolerance (D)+	0,1 mm	Number of solder pins per pole	2
Screwdriver blade	1.0 x 5.5, PZ 2	Screwdriver blade standard	DIN 5264
Tightening torque, min.	1.2 Nm	Tightening torque, max.	1.5 Nm
Clamping screw	M 4	Stripping length	12 mm
L1 in mm	63.5 mm	L1 in inches	2.5 inch
Touch-safe protection acc. to DIN VDE 0470	IP20 plugged/ IP10 unplugged	Touch-safe protection acc. to DIN VDE 57 106	Safe from finger touch
Protection degree	IP20	Volume resistance	0.50 mΩ

## Material data

Insulating material	Wemid (PA)	Colour	black
Colour chart (similar)	RAL 9011	Insulating material group	I
Comparative Tracking Index (CTI)	≥ 600	UL 94 flammability rating	V-0
Contact material	E-Cu	Contact surface	tinned
Layer structure of solder connection	1.5...3 μm Ni / 4...6 μm Sn matt	Storage temperature, min.	-40 °C
Storage temperature, max.	70 °C	Operating temperature, min.	-50 °C
Operating temperature, max.	120 °C	Temperature range, installation, min.	-25 °C
Temperature range, installation, max.	120 °C		

## Conductors suitable for connection

Clamping range, min.	0.13 mm <sup>2</sup>
Clamping range, max.	16 mm <sup>2</sup>
Wire connection cross section AWG, min.	AWG 22
Wire connection cross section AWG, max.	AWG 6
Solid, min. H05(07) V-U	0.5 mm <sup>2</sup>
Solid, max. H05(07) V-U	16 mm <sup>2</sup>
Stranded, min. H07V-R	6 mm <sup>2</sup>
Stranded, max. H07V-R	16 mm <sup>2</sup>
Flexible, min. H05(07) V-K	0.5 mm <sup>2</sup>
Flexible, max. H05(07) V-K	16 mm <sup>2</sup>
w. plastic collar ferrule, DIN 46228 pt 4,	2.5 mm <sup>2</sup>
min.	

Creation date March 9, 2023 7:05:28 PM CET

## LUP 12.70/06/90 5.0SN BK BX

**Weidmüller Interface GmbH & Co. KG**  
 Klingenbergstraße 26  
 D-32758 Detmold  
 Germany

www.weidmueller.com

## Technical data

w. plastic collar ferrule, DIN 46228 pt 4, 10 mm<sup>2</sup>  
 max.

w. wire end ferrule, DIN 46228 pt 1, 2.5 mm<sup>2</sup>  
 min.

w. wire end ferrule, DIN 46228 pt 1, 10 mm<sup>2</sup>  
 max.

Plug gauge in accordance with EN 60999 a x b; ø 5.4 mm x 5.1 mm; 5.3 mm

Clampable conductor	Cross-section for conductor connection	Type	fine-wired
		nominal	2.5 mm <sup>2</sup>
wire end ferrule	wire end ferrule	Stripping length	nominal 12 mm
		Recommended wire-end ferrule	<a href="#">H2.5/12</a>
		Stripping length	nominal 14 mm
		Recommended wire-end ferrule	<a href="#">H2.5/19D BL</a>
Cross-section for conductor connection	Type	fine-wired	
	nominal	4 mm <sup>2</sup>	
wire end ferrule	wire end ferrule	Stripping length	nominal 12 mm
		Recommended wire-end ferrule	<a href="#">H4.0/12</a>
		Stripping length	nominal 14 mm
		Recommended wire-end ferrule	<a href="#">H4.0/20D GR</a>
Cross-section for conductor connection	Type	fine-wired	
	nominal	6 mm <sup>2</sup>	
wire end ferrule	wire end ferrule	Stripping length	nominal 12 mm
		Recommended wire-end ferrule	<a href="#">H6.0/12</a>
		Stripping length	nominal 14 mm
		Recommended wire-end ferrule	<a href="#">H6.0/20 SW</a>
Cross-section for conductor connection	Type	fine-wired	
	nominal	10 mm <sup>2</sup>	
wire end ferrule	wire end ferrule	Stripping length	nominal 15 mm
		Recommended wire-end ferrule	<a href="#">H10.0/22 EB</a>
		Stripping length	nominal 12 mm
		Recommended wire-end ferrule	<a href="#">H10.0/12</a>

Reference text Length of ferrules is to be chosen depending on the product and the rated voltage., The outside diameter of the plastic collar should not be larger than the pitch (P)

### Rated data acc. to IEC

tested acc. to standard		Rated current, min. number of poles (Tu=20°C)	
	IEC 60664-1, IEC 61984		76 A
Rated current, max. number of poles (Tu=20°C)	74 A	Rated current, min. number of poles (Tu=40°C)	76 A
Rated current, max. number of poles (Tu=40°C)	64 A	Rated voltage for surge voltage class / pollution degree II/2	1,000 V
Rated voltage for surge voltage class / pollution degree III/2	1,000 V	Rated voltage for surge voltage class / pollution degree III/3	1,000 V
Rated impulse voltage for surge voltage class/ pollution degree II/2	6 kV	Rated impulse voltage for surge voltage class/ pollution degree III/2	8 kV
Rated impulse voltage for surge voltage class/ contamination degree III/3	8 kV	Short-time withstand current resistance	1 x 1s with 700 A

## LUP 12.70/06/90 5.0SN BK BX

**Weidmüller Interface GmbH & Co. KG**  
Klingenbergstraße 26  
D-32758 Detmold  
Germany

www.weidmueller.com

## Technical data

## Rated data acc. to CSA

Rated voltage (Use group B / CSA)	600 V	Rated voltage (Use group C / CSA)	600 V
Rated current (Use group B / CSA)	65 A	Rated current (Use group C / CSA)	65 A
Wire cross-section, AWG, min.	AWG 22	Wire cross-section, AWG, max.	AWG 6

## Rated data acc. to UL 1059

Institute (cURus)		Certificate No. (cURus)	E60693
Rated voltage (Use group B / UL 1059)	600 V	Rated voltage (Use group C / UL 1059)	600 V
Rated current (Use group B / UL 1059)	65 A	Rated current (Use group C / UL 1059)	65 A
Wire cross-section, AWG, min.	AWG 22	Wire cross-section, AWG, max.	AWG 6
Reference to approval values	Specifications are maximum values, details - see approval certificate.		

## Packing

Packaging	Box	VPE length	315 mm
VPE width	87 mm	VPE height	68 mm

## Classifications

ETIM 6.0	EC002643	ETIM 7.0	EC002643
ETIM 8.0	EC002643	ECLASS 9.0	27-44-04-01
ECLASS 9.1	27-44-04-01	ECLASS 10.0	27-44-04-01
ECLASS 11.0	27-46-01-01	ECLASS 12.0	27-46-01-01

## Important note

IPC conformity	Conformity: The products are developed, manufactured and delivered according international recognized standards and norms and comply with the assured properties in the data sheet resp. fulfill decorative properties in accordance with IPC-A-610 "Class 2". Further claims on the products can be evaluated on request.
Notes	<ul style="list-style-type: none"> <li>• Additional variants on request</li> <li>• Rated current related to rated cross-section &amp; min. No. of poles.</li> <li>• Wire end ferrule without plastic collar to DIN 46228/1</li> <li>• Wire end ferrule with plastic collar to DIN 46228/4</li> <li>• The data given under CSA relates to a cUL approval - E60693</li> <li>• P on drawing = pitch</li> <li>• Rated data refer only to the component itself. Clearance and creepage distances to other components are to be designed in accordance with the relevant application standards.</li> <li>• Long term storage of the product with average temperature of 50 °C and average humidity 70%, 36 months</li> </ul>

## LUP 12.70/06/90 5.0SN BK BX

**Weidmüller Interface GmbH & Co. KG**  
Klingenbergstraße 26  
D-32758 Detmold  
Germany

[www.weidmueller.com](http://www.weidmueller.com)

## Technical data

### Approvals

Approvals



ROHS	Conform
UL File Number Search	UL Website
Certificate No. (cURus)	E60693

### Downloads

Approval/Certificate/Document of Conformity	<a href="#">Declaration of the Manufacturer</a>
Engineering Data	<a href="#">CAD data – STEP</a>
Product Change Notification	<a href="#">20220201 Visual change OMNIMATE® Power PCB terminal blocks and connectors</a> <a href="#">20220201 Visuelle Änderung OMNIMATE® Power Leiterplattenklemmen und -steckverbinder</a>
User Documentation	<a href="#">QR-Code product handling video</a>
Catalogues	<a href="#">Catalogues in PDF-format</a>
Brochures	<a href="#">FL DRIVES EN</a> <a href="#">MB DEVICE MANUF. EN</a> <a href="#">FL DRIVES DE</a> <a href="#">FL APPL_INVERTER EN</a> <a href="#">FL_BASE_STATION EN</a> <a href="#">FL ELEVATOR EN</a> <a href="#">FL POWER SUPPLY EN</a> <a href="#">FL 72H SAMPLE SER EN</a> <a href="#">PO OMNIMATE EN</a>

**LUP 12.70/06/90 5.0SN BK BX**

**Weidmüller Interface GmbH & Co. KG**  
 Klängenbergstraße 26  
 D-32758 Detmold  
 Germany

www.weidmueller.com

Drawings

Dimensional drawing

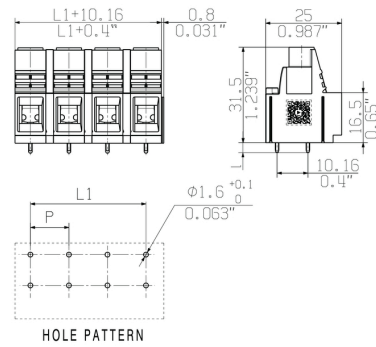

Graph

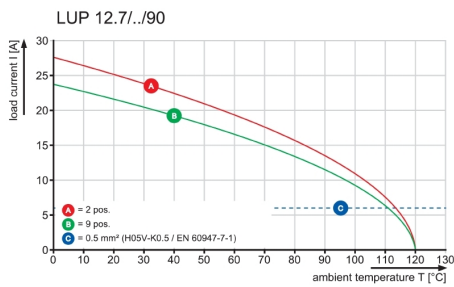

Graph

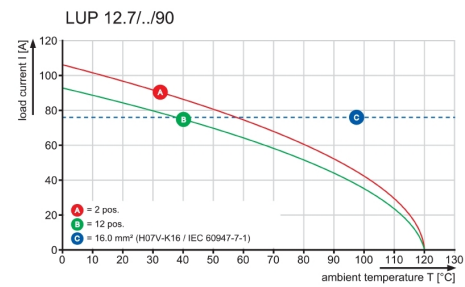

PS 2.0 / ORDER NO.  
031000 0000

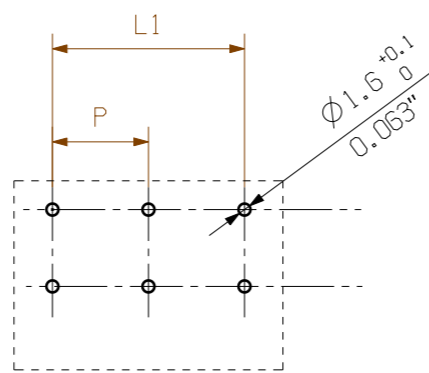
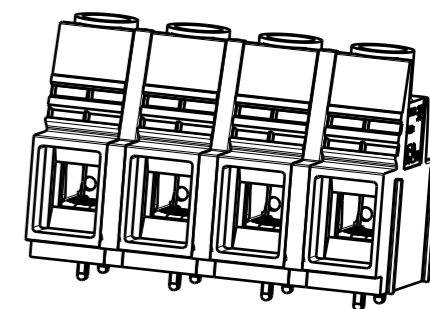
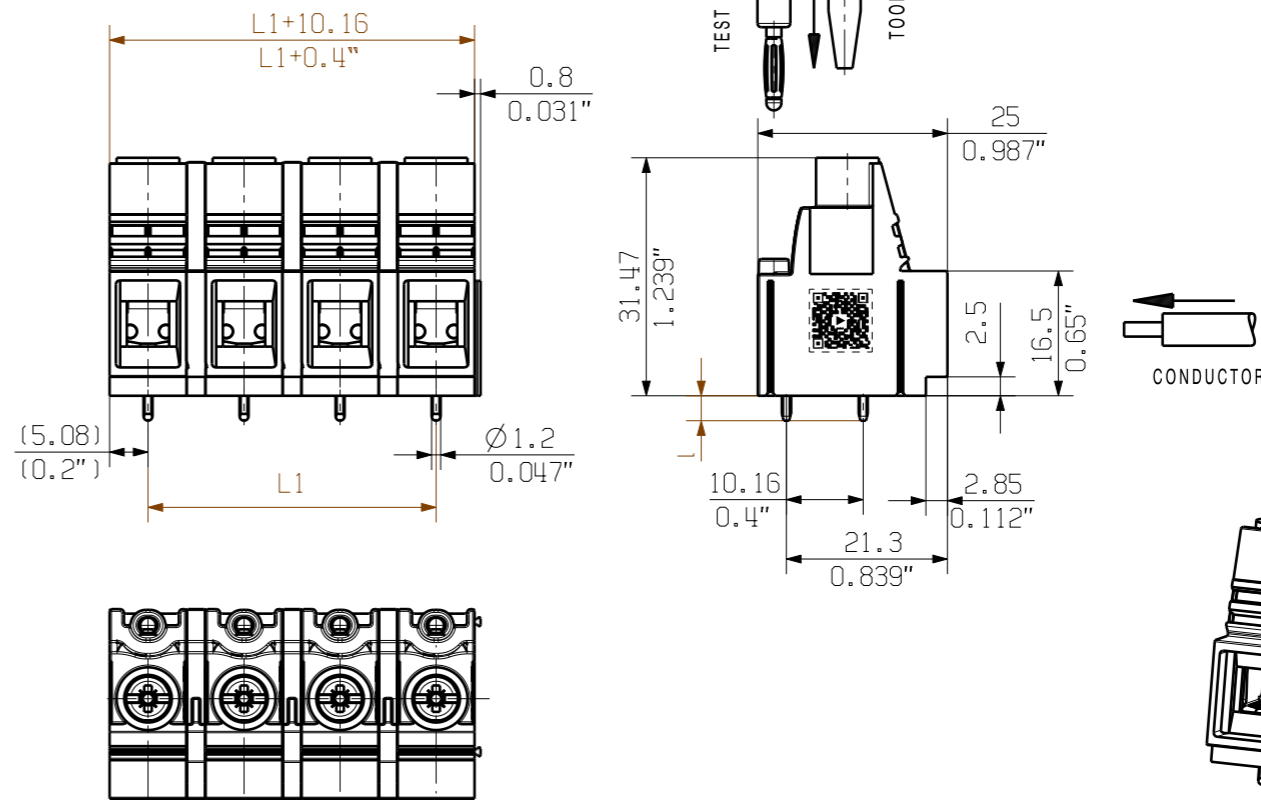

HOLE PATTERN (BLOCK)

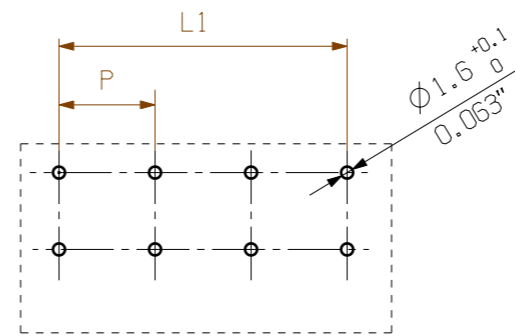

HOLE PATTERN

n=NO OF POLES  
 P= PITCH=12.70  
 l= STIFTLAENGE/ 5.0mm/0.197"  
 PIN LENGTH 3.2mm/0.126"  
 SHOWN: LUP 12.70/02/90...SO (BLOCK)  
 LUP 12.70/03/90...SO (BLOCK)  
 LUP 12.7/04/90... (SINGLE POL)

For the mounting of PCBs, it should be noted that the rated data given in the catalogue relates only to the connection elements. The necessary creepage and clearance paths must be observed in connection with the respective applicant in accordance to VDE 0110. The current-carrying capacity and pitch tolerance is to be determined according to DIN IEC 326 part 3 very fine.

Weidmüller connectors are tested to the DIN VDE 0627 standard, and are valid for its field of application. Provided that the connectors are used to the intended purpose, all requirements with respect to the occurring of electrical, mechanical, thermic and corrosive stress will be satisfied.

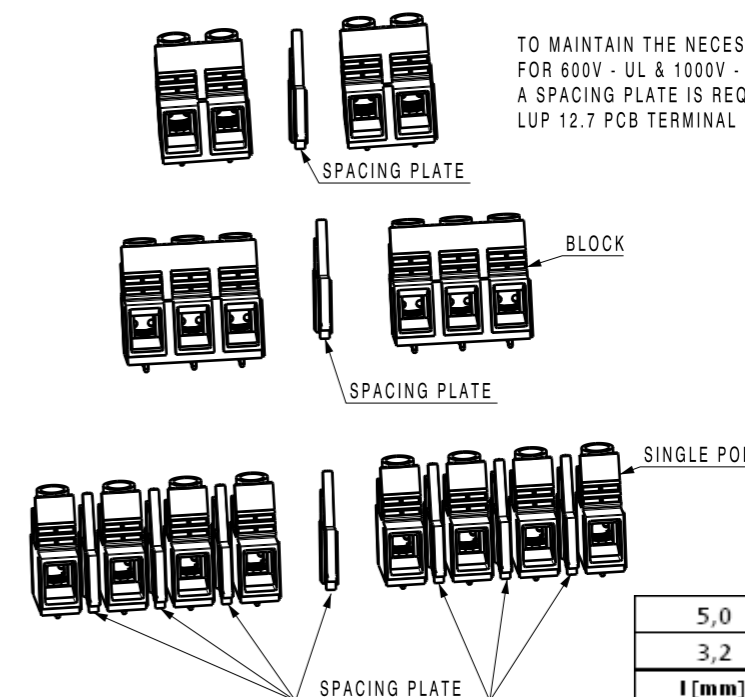

TO MAINTAIN THE NECESSARY VOLTAGE DISTANCES FOR 600V - UL & 1000V - IEC, A SPACING PLATE IS REQUIRED BETWEEN ASSEMBLED LUP 12.7 PCB TERMINAL BLOCKS

12	139,70	5,500
11	127,00	5,000
10	114,30	4,500
9	101,60	4,000
8	88,90	3,500
7	76,20	3,000
6	63,50	2,500
5	50,80	2,000
4	38,10	1,500
5,0	3	25,40 1,000
3,2	2	12,70 0,500
l [mm]	n	L1 [mm] L1 [inch]

GENERAL TOLERANCE:  
DIN ISO 2768-mK

102479	Prim PLM Part No.: 411688	Prim ERP Part No.: 1160810000
RoHS COMPLIANT	First Issue Date 03.03.2018	Modification
Scale: 2:1	Size: A3	Drawings Assembly
	Date: 03.03.2018 Name: Administrator Responsible: Amann, Alexander Approved:	Drawing no. <b>34163</b> Issue no. <b>10</b> Sheet 02 of 02 sheets
LUP12.70/././90		Product file: 7233 LUP 10.16/12.7

not released

## Recommended wave soldering profiles

**Weidmüller Interface GmbH & Co. KG**  
 Klängenbergstraße 16  
 D-32758 Detmold  
 Germany  
 Fon: +49 5231 14-0  
 Fax: +49 5231 14-292083  
 www.weidmueller.com

### Single Wave:



### Double Wave:



### Wave soldering profiles

Wired connection elements should be processed in accordance with the DIN EN 61760-1 standard. We have included two recommendations for practical wave soldering profiles, with which Weidmüller PCB terminals and connectors are qualified.

When choosing a suitable profile for your application, the following factors also need to be considered:

- PCB thickness
- Proportion of Cu in the layers
- Single/double-sided assembly
- Product range
- Heating and cooling rates

The single and double wave profiles each indicate the recommended operating range, including the maximum soldering temperature of 260°C. In practice, the maximum soldering temperature is quite often well below the above maximum profile.