

LUF 10.00/10/90V 5.0SN BK BX

Weidmüller Interface GmbH & Co. KG
 Klingenbergstraße 26
 D-32758 Detmold
 Germany

www.weidmueller.com

Product image

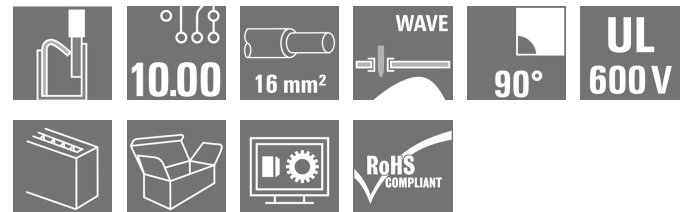

Similar to illustration

High-performance PCB terminal with a PUSH IN connection system for conductor cross-sections up to 16 mm².

- Fast connection without tools thanks to pushers to open the contact point, or direct plug-in method
- Securely closed contact point, with the "Connection Safety Concept" the conductor is always clamped securely
- Integrated test point for PS 2.0 test plug
- Central tip test point for test probes on the upper side of the terminal
- Increased derating reserves because WEMID insulating material is used.
- Conductor outlet direction of 180°

General ordering data

Version	Printed circuit board terminals, 10.00 mm, Number of poles: 10, 90°, Solder pin length (l): 5 mm, black, PUSH IN with actuator, Clamping range, max. : 16 mm ² , Box
Order No.	2453770000
Type	LUF 10.00/10/90V 5.0SN BK BX
GTIN (EAN)	4050118493672
Qty.	10 pc(s).
Product data	IEC: 1000 V / 92 A / 0.5 - 25 mm ² UL: 600 V / 58 A / AWG 18 - AWG 6
Packaging	Box

Creation date March 9, 2023 8:56:00 PM CET

LUF 10.00/10/90V 5.0SN BK BX**Weidmüller Interface GmbH & Co. KG**

Klingenbergstraße 26

D-32758 Detmold

Germany

www.weidmueller.com

Technical data**Dimensions and weights**

Depth	26.45 mm	Depth (inches)	1.041 inch
Height	47.03 mm	Height (inches)	1.852 inch
Height of lowest version	42.03 mm	Width	101.58 mm
Width (inches)	3.999 inch	Net weight	104.4 g

Temperatures

Operating temperature, min.	-40 °C	Operating temperature, max.	120 °C
-----------------------------	--------	-----------------------------	--------

System parameters

Product family	OMNIMATE Power - series LU	Wire connection method	PUSH IN with actuator
Mounting onto the PCB	THT solder connection	Conductor outlet direction	90°
Pitch in mm (P)	10 mm	Pitch in inches (P)	0.394 inch
Number of poles	10	Pin series quantity	1
Fitted by customer	No	Number of rows	1
Solder pin length (l)	5 mm	Solder pin dimensions	d = 1.2 mm, Octagonal
Solder eyelet hole diameter (D)	1.6 mm	Solder eyelet hole diameter tolerance (D)	+ 0, 1 mm
Number of solder pins per pole	2	Screwdriver blade	0.8 x 4.0
Stripping length	18 mm	L1 in mm	90 mm
L1 in inches	3.543 inch	Touch-safe protection acc. to DIN VDE 0470	IP20 plugged/ IP10 unplugged
Touch-safe protection acc. to DIN VDE 57 106	touch-safe with connected connectors from 6 mm ²	Protection degree	IP20

Material data

Insulating material	Wemid (PA)	Colour	black
Colour chart (similar)	RAL 9011	Insulating material group	I
Comparative Tracking Index (CTI)	≥ 600	UL 94 flammability rating	V-0
Contact base material	E-Cu	Storage temperature, min.	-40 °C
Storage temperature, max.	70 °C	Operating temperature, min.	-40 °C
Operating temperature, max.	120 °C		

Conductors suitable for connection

Clamping range, min.	0.5 mm ²
Clamping range, max.	16 mm ²
Solid, min. H05(07) V-U	0.5 mm ²
Solid, max. H05(07) V-U	16 mm ²
Stranded, min. H07V-R	6 mm ²
Stranded, max. H07V-R	25 mm ²
Flexible, min. H05(07) V-K	0.5 mm ²
Flexible, max. H05(07) V-K	25 mm ²
w. plastic collar ferrule, DIN 46228 pt 4, 0.5 mm ² min.	
w. plastic collar ferrule, DIN 46228 pt 4, 16 mm ² max.	
w. wire end ferrule, DIN 46228 pt 1, min.	0.5 mm ²
w. wire end ferrule, DIN 46228 pt 1, max.	16 mm ²
Plug gauge in accordance with EN 60999 a x b; ø	5.3mm (B6)

Creation date March 9, 2023 8:56:00 PM CET

Catalogue status 03.03.2023 / We reserve the right to make technical changes.

2

LUF 10.00/10/90V 5.0SN BK BX

Weidmüller Interface GmbH & Co. KG
 Klingenbergstraße 26
 D-32758 Detmold
 Germany

www.weidmueller.com

Technical data

Clampable conductor	Cross-section for conductor connection	Type	fine-wired	
		nominal	2.5 mm ²	
	wire end ferrule	Stripping length	nominal	20 mm
		Recommended wire-end ferrule	H2.5/25D BL	
		Stripping length	nominal	18 mm
		Recommended wire-end ferrule	H2.5/18	
	Cross-section for conductor connection	Type	fine-wired	
		nominal	4 mm ²	
	wire end ferrule	Stripping length	nominal	20 mm
		Recommended wire-end ferrule	H4.0/26D GR	
		Stripping length	nominal	18 mm
		Recommended wire-end ferrule	H4.0/18	
	Cross-section for conductor connection	Type	fine-wired	
		nominal	6 mm ²	
	wire end ferrule	Stripping length	nominal	20 mm
		Recommended wire-end ferrule	H6.0/26 SW	
		Stripping length	nominal	18 mm
		Recommended wire-end ferrule	H6.0/18	
	Cross-section for conductor connection	Type	fine-wired	
		nominal	10 mm ²	
	wire end ferrule	Stripping length	nominal	21 mm
		Recommended wire-end ferrule	H10.0/28 EB	
		Stripping length	nominal	18 mm
		Recommended wire-end ferrule	H10.0/18	
Cross-section for conductor connection	Type	fine-wired		
	nominal	16 mm ²		
wire end ferrule	Stripping length	nominal	21 mm	
	Recommended wire-end ferrule	H16.0/28 GN		
	Stripping length	nominal	18 mm	
	Recommended wire-end ferrule	H16.0/18		
Cross-section for conductor connection	Type	fine-wired		
	nominal	1.5 mm ²		
wire end ferrule	Stripping length	nominal	20 mm	
	Recommended wire-end ferrule	H1.5/24 R		
	Stripping length	nominal	18 mm	
	Recommended wire-end ferrule	H1.5/18		

Reference text Length of ferrules is to be chosen depending on the product and the rated voltage., The outside diameter of the plastic collar should not be larger than the pitch (P)

LUF 10.00/10/90V 5.0SN BK BX

Weidmüller Interface GmbH & Co. KG

Klingenbergstraße 26

D-32758 Detmold

Germany

www.weidmueller.com

Technical data

Rated data acc. to IEC

tested acc. to standard	IEC 60947-7-4	Rated current, min. number of poles (Tu=20°C)	92 A
Rated current, max. number of poles (Tu=20°C)	80 A	Rated current, min. number of poles (Tu=40°C)	82 A
Rated current, max. number of poles (Tu=40°C)	76 A	Rated voltage for surge voltage class / pollution degree II/2	1,000 V
Rated voltage for surge voltage class / pollution degree III/2	690 V	Rated voltage for surge voltage class / pollution degree III/3	1,000 V
Rated impulse voltage for surge voltage class/ pollution degree II/2	6 kV	Rated impulse voltage for surge voltage class/ pollution degree III/2	6 kV
Rated impulse voltage for surge voltage class/ contamination degree III/3	8 kV		

Rated data acc. to CSA

Rated voltage (Use group B / CSA)	600 V	Rated voltage (Use group C / CSA)	600 V
Rated voltage (Use group D / CSA)	600 V	Rated current (Use group B / CSA)	58 A
Rated current (Use group C / CSA)	58 A	Rated current (Use group D / CSA)	5 A
Wire cross-section, AWG, min.	AWG 18	Wire cross-section, AWG, max.	AWG 6

Rated data acc. to UL 1059

Institute (cURus)		Certificate No. (cURus)	E60693
Rated voltage (Use group B / UL 1059)	600 V	Rated voltage (Use group C / UL 1059)	600 V
Rated voltage (Use group D / UL 1059)	600 V	Rated current (Use group B / UL 1059)	58 A
Rated current (Use group C / UL 1059)	58 A	Rated current (Use group D / UL 1059)	5 A
Wire cross-section, AWG, min.	AWG 18	Wire cross-section, AWG, max.	AWG 6
Reference to approval values	Specifications are maximum values, details - see approval certificate.		

Packing

Packaging	Box	VPE length	317 mm
VPE width	111 mm	VPE height	53 mm

Type tests

Test: Durability of markings	Standard	IEC 60947-1 section 8.2.4.5.1 / 06.07, IEC 60512-1-1:2002-02
	Test	mark of origin, type identification, pitch, durability
	Evaluation	available

LUF 10.00/10/90V 5.0SN BK BX

Weidmüller Interface GmbH & Co. KG
 Klingenbergstraße 26
 D-32758 Detmold
 Germany

www.weidmueller.com

Technical data

Test: Clampable cross section	Standard	IEC 60999-1 section 7 and 9.1 / 11.99, IEC 60947-1 section 8.2.4.5.1 / 03.11	
	Conductor type	Type of conductor and conductor cross-section	solid 0.5 mm ²
		Type of conductor and conductor cross-section	stranded 0.5 mm ²
		Type of conductor and conductor cross-section	solid 16 mm ²
		Type of conductor and conductor cross-section	stranded 16 mm ²
		Type of conductor and conductor cross-section	H07V-U16
		Type of conductor and conductor cross-section	H07V-U6
		Type of conductor and conductor cross-section	H07V-K16
Evaluation	passed		
Test for damage to and accidental loosening of conductors	Standard	IEC 60999-1 section 9.4 / 11.99	
	Requirement	0.3 kg	
	Conductor type	Type of conductor and conductor cross-section	AWG 20/1
		Type of conductor and conductor cross-section	AWG 20/19
		Type of conductor and conductor cross-section	H05V-U0.5
		Type of conductor and conductor cross-section	H05V-K0.5
	Evaluation	passed	
	Requirement	2.9 kg	
Conductor type	Type of conductor and conductor cross-section	H07V-U16	
	Type of conductor and conductor cross-section	H07V-K16	
Evaluation	passed		

LUF 10.00/10/90V 5.0SN BK BX

Weidmüller Interface GmbH & Co. KG
 Klingenbergstraße 26
 D-32758 Detmold
 Germany

www.weidmueller.com

Technical data

Pull-out test	Standard	IEC 60999-1 section 9.5 / 11.99		
	Requirement	≥20 N		
	Conductor type	Type of conductor and conductor cross-section	AWG 20/1	
		Type of conductor and conductor cross-section	AWG 20/19	
		Type of conductor and conductor cross-section	H05V-U0.5	
		Type of conductor and conductor cross-section	H05V-K0.5	
	Evaluation	passed		
	Requirement	≥100 N		
	Conductor type	Type of conductor and conductor cross-section	H07V-U16	
		Type of conductor and conductor cross-section	H07V-K16	
Evaluation	passed			

Classifications

ETIM 6.0	EC002643	ETIM 7.0	EC002643
ETIM 8.0	EC002643	ECLASS 9.0	27-44-04-01
ECLASS 9.1	27-44-04-01	ECLASS 10.0	27-44-04-01
ECLASS 11.0	27-46-01-01	ECLASS 12.0	27-46-01-01

Important note

IPC conformity	Conformity: The products are developed, manufactured and delivered according international recognized standards and norms and comply with the assured properties in the data sheet resp. fulfill decorative properties in accordance with IPC-A-610 "Class 2". Further claims on the products can be evaluated on request.
Notes	<ul style="list-style-type: none"> • Additional variants on request • Rated current related to rated cross-section & min. No. of poles. • Wire end ferrule without plastic collar to DIN 46228/1 • Wire end ferrule with plastic collar to DIN 46228/4 • P on drawing = pitch • Rated data refer only to the component itself. Clearance and creepage distances to other components are to be designed in accordance with the relevant application standards. • The test point can only be used as potential-pickup point. • The single-position PCB terminal block can be used for voltages up to 1500 V (DC) and 1000 V (AC). The relevant device standard and the appropriate required clearances and creepage distances should be observed in the application • Long term storage of the product with average temperature of 50 °C and average humidity 70%, 36 months

LUF 10.00/10/90V 5.0SN BK BX**Weidmüller Interface GmbH & Co. KG**

Klingenbergstraße 26

D-32758 Detmold

Germany

www.weidmueller.com

Technical data**Approvals**

Approvals



ROHS	Conform
UL File Number Search	UL Website
Certificate No. (cURus)	E60693

Downloads

Approval/Certificate/Document of Conformity	Declaration of the Manufacturer
Engineering Data	CAD data – STEP
Engineering Data	WSCAD
Product Change Notification	20210909 Color Change of Actuator to LLF(S) and LUF(S) Family 20210909 LLF(S) und LUF(S) Familie - Farbänderung des Betätigungselementes
User Documentation	QR-Code product handling video Assembly instruction_Montageanleitung_LLFLUF_EN_DE
Catalogues	Catalogues in PDF-format
Brochures	FL DRIVES EN MB DEVICE MANUF. EN FL DRIVES DE FL APPL_INVERTER EN FL_BASE_STATION EN FL ELEVATOR EN FL POWER SUPPLY EN FL 72H SAMPLE SER EN PO OMNIMATE EN

LUF 10.00/10/90V 5.0SN BK BX

Weidmüller Interface GmbH & Co. KG
 Klingenbergstraße 26
 D-32758 Detmold
 Germany

www.weidmueller.com

Drawings

Dimensional drawing

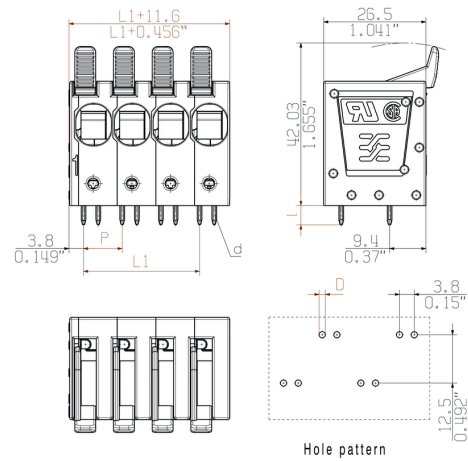

Derating curve

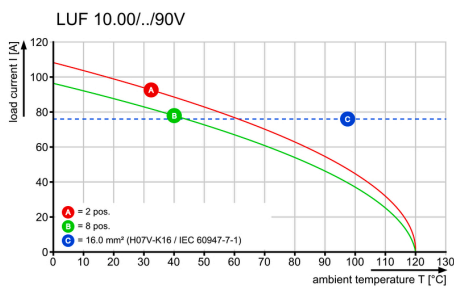

Derating curve

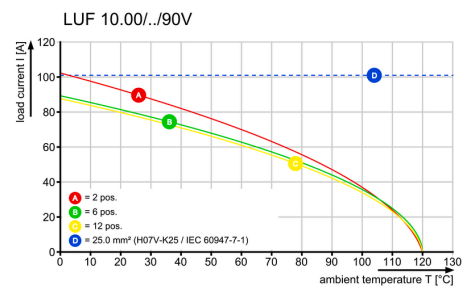

Product benefits

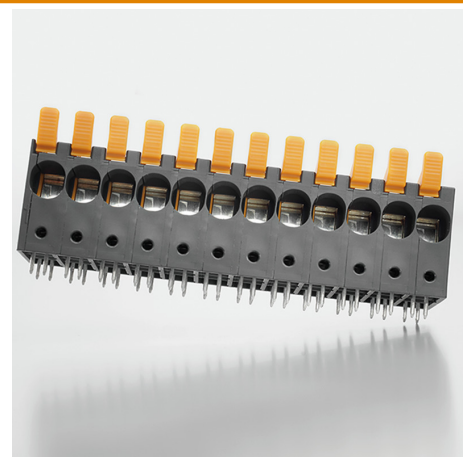

High stability through pin design

Data sheet**LUF 10.00/10/90V 5.0SN BK BX**

Weidmüller Interface GmbH & Co. KG
Klingenbergstraße 26
D-32758 Detmold
Germany

www.weidmueller.com

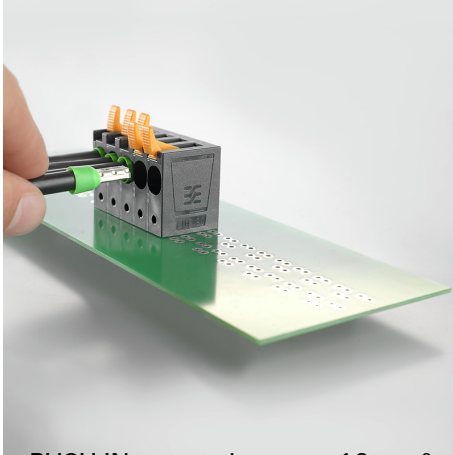
Drawings**Product benefits**

PUSH IN connection up to 16 mm²

Recommended wave soldering profiles

Weidmüller Interface GmbH & Co. KG
 Klingenbergstraße 16
 D-32758 Detmold
 Germany
 Fon: +49 5231 14-0
 Fax: +49 5231 14-292083
 www.weidmueller.com

Single Wave:



Double Wave:

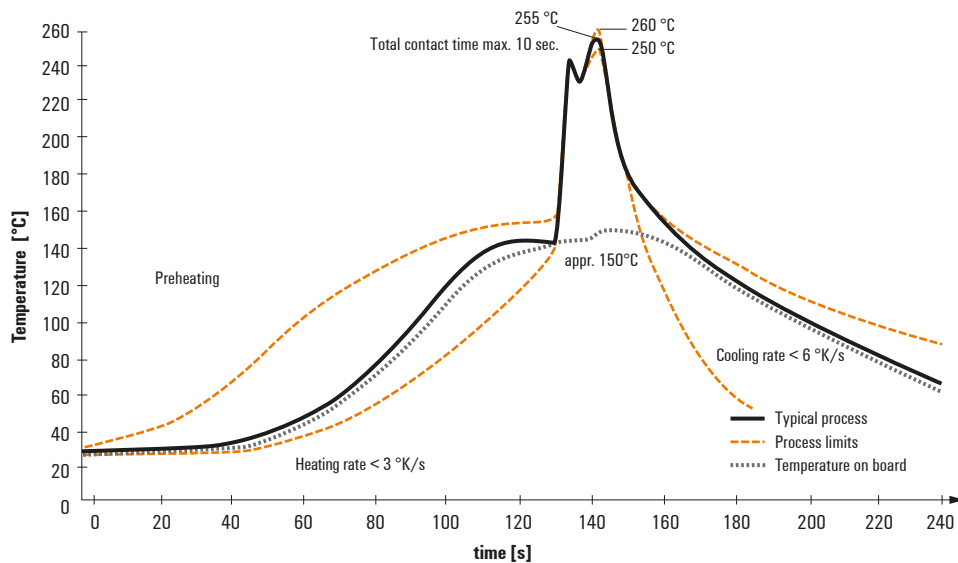

Wave soldering profiles

Wired connection elements should be processed in accordance with the DIN EN 61760-1 standard. We have included two recommendations for practical wave soldering profiles, with which Weidmüller PCB terminals and connectors are qualified.

When choosing a suitable profile for your application, the following factors also need to be considered:

- PCB thickness
- Proportion of Cu in the layers
- Single/double-sided assembly
- Product range
- Heating and cooling rates

The single and double wave profiles each indicate the recommended operating range, including the maximum soldering temperature of 260°C. In practice, the maximum soldering temperature is quite often well below the above maximum profile.