

LLFS 7.50/12/180V 5.0SN BK BX

Weidmüller Interfaces GmbH & Co. KG

Postfach 3030

32760 Detmold

Tel. +49 5231 14-0

Fax. +49 5231 14-2083

info@weidmueller.com

www.weidmueller.com

Product image

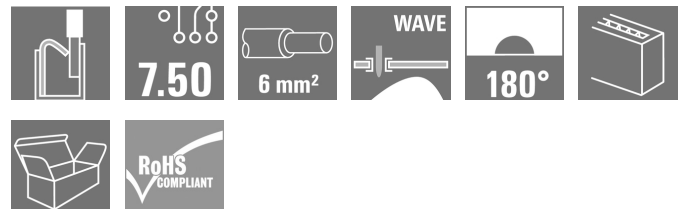
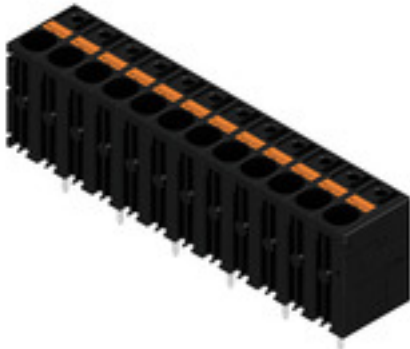

The sturdy, direct connection for extreme current and voltage requirements in all power electronics applications such as solar inverters, frequency converters, servo-controllers and power supplies.

General ordering data

Version	Printed circuit board terminals, 7.50 mm, Number of poles: 12, 180°, Solder pin length (l): 5 mm, tinned, black, PUSH IN without actuator, Clamping range, max. : 6 mm², Box
Order No.	2491720000
Type	LLFS 7.50/12/180V 5.0SN BK BX
GTIN (EAN)	4050118607758
Qty.	20 Stück
Product data	IEC: 1000 V / 41 A / 0.5 - 6 mm² UL: 600 V / 37 A / AWG 24 - AWG 8
Packaging	Box

LLFS 7.50/12/180V 5.0SN BK BX

Weidmüller Interfaces GmbH & Co. KG

Postfach 3030

32760 Detmold

Tel. +49 5231 14-0

Fax. +49 5231 14-2083

info@weidmueller.com

www.weidmueller.com

Technische Daten

Dimensions and weights

Depth	18.5 mm	Depth (inches)	0.728 inch
Height	29.15 mm	Height (inches)	1.148 inch
Height of lowest version	24.15 mm	Width	91.8 mm
Width (inches)	3.614 inch	Net weight	43.23 g

Temperatures

Operating temperature, min.	-40 °C	Operating temperature, max.	120 °C
-----------------------------	--------	-----------------------------	--------

System parameters

Product family	OMNIMATE Power - series LL	Wire connection method	PUSH IN without actuator
Mounting onto the PCB	THT solder connection	Conductor outlet direction	180°
Pitch in mm (P)	7.5 mm	Pitch in inches (P)	0.295 inch
Number of poles	12	Pin series quantity	1
Fitted by customer	No	Number of rows	1
Solder pin length (l)	5 mm	Solder pin dimensions	d = 1.5 mm
Solder eyelet hole diameter (D)	2 mm	Solder eyelet hole diameter tolerance (D)	+ 0,1 mm
Number of solder pins per pole	1	Stripping length	12 mm
L1 in mm	82.5 mm	L1 in inches	3.248 inch
Touch-safe protection acc. to DIN VDE 0470	IP 20	Touch-safe protection acc. to DIN VDE 57 106	Safe from finger touch
Protection degree	IP20		

Material data

Insulating material	Wemid (PA)	Colour	black
Colour chart (similar)	RAL 9011	Insulating material group	I
Insulation strength	≥ 10 ⁸ Ω	UL 94 flammability rating	V-0
Contact material	E-Cu	Contact surface	tinned
Layer structure of solder connection	4...10 μ Sn matt	Storage temperature, min.	-40 °C
Storage temperature, max.	70 °C	Operating temperature, min.	-40 °C
Operating temperature, max.	120 °C		

Conductors suitable for connection

Clamping range, min.	0.25 mm ²
Clamping range, max.	6 mm ²
Wire connection cross section AWG, min.	AWG 24
Wire connection cross section AWG, max.	AWG 8
Solid, min. H05(07) V-U	0.5 mm ²
Solid, max. H05(07) V-U	6 mm ²
Stranded, min. H07V-R	0.5 mm ²
Flexible, min. H05(07) V-K	0.5 mm ²
Flexible, max. H05(07) V-K	6 mm ²
w. plastic collar ferrule, DIN 46228 pt 4, 0.25 mm ² min.	
w. plastic collar ferrule, DIN 46228 pt 4, 6 mm ² max.	
w. wire end ferrule, DIN 46228 pt 1, 0.25 mm ² min.	
w. wire end ferrule, DIN 46228 pt 1, 6 mm ² max.	

Erstellungs-Datum May 31, 2023 1:54:37 PM CEST

LLFS 7.50/12/180V 5.0SN BK BX

Weidmüller Interfaces GmbH & Co. KG

Postfach 3030

32760 Detmold

Tel. +49 5231 14-0

Fax. +49 5231 14-2083

Technische Daten

Clampable conductor	Cross-section for conductor connection	Type	fine-wired
		nominal	0.5 mm ²
wire end ferrule	Stripping length	nominal	14 mm
	Recommended wire-end ferrule	H0.5/18 OR	
Cross-section for conductor connection	Type	fine-wired	
	nominal	1 mm ²	
wire end ferrule	Stripping length	nominal	15 mm
	Recommended wire-end ferrule	H1.0/18 GE	
Cross-section for conductor connection	Type	fine-wired	
	nominal	1.5 mm ²	
wire end ferrule	Stripping length	nominal	15 mm
	Recommended wire-end ferrule	H1.5/18D SW	
	Stripping length	nominal	12 mm
	Recommended wire-end ferrule	H1.5/12	
Cross-section for conductor connection	Type	fine-wired	
	nominal	0.75 mm ²	
wire end ferrule	Stripping length	nominal	14 mm
	Recommended wire-end ferrule	H0.75/18 W	
Cross-section for conductor connection	Type	fine-wired	
	nominal	2.5 mm ²	
wire end ferrule	Stripping length	nominal	14 mm
	Recommended wire-end ferrule	H2.5/19D BL	
	Stripping length	nominal	12 mm
	Recommended wire-end ferrule	H2.5/12	
Cross-section for conductor connection	Type	fine-wired	
	nominal	4 mm ²	
wire end ferrule	Stripping length	nominal	12 mm
	Recommended wire-end ferrule	H4.0/12	
	Stripping length	nominal	14 mm
	Recommended wire-end ferrule	H4.0/20D GR	
Cross-section for conductor connection	Type	fine-wired	
	nominal	6 mm ²	
wire end ferrule	Stripping length	nominal	14 mm
	Recommended wire-end ferrule	H6.0/20 SW	
	Stripping length	nominal	12 mm
	Recommended wire-end ferrule	H6.0/12	

Reference text Length of ferrules is to be chosen depending on the product and the rated voltage., The outside diameter of the plastic collar should not be larger than the pitch (P)

LLFS 7.50/12/180V 5.0SN BK BX

Weidmüller Interfaces GmbH & Co. KG

Postfach 3030

32760 Detmold

Tel. +49 5231 14-0

Fax. +49 5231 14-2083

info@weidmueller.com

www.weidmueller.com

Technische Daten

Rated data acc. to IEC

tested acc. to standard	In accordance with IEC 60947-7-1	Rated current, min. number of poles (Tu=20°C)	41 A
Rated current, max. number of poles (Tu=20°C)	32 A	Rated current, min. number of poles (Tu=40°C)	38 A
Rated current, max. number of poles (Tu=40°C)	28 A	Rated voltage for surge voltage class / pollution degree II/2	1,000 V
Rated voltage for surge voltage class / pollution degree III/2	1,000 V	Rated voltage for surge voltage class / pollution degree III/3	1,000 V
Rated impulse voltage for surge voltage class/ pollution degree II/2	8 kV	Rated impulse voltage for surge voltage class/ pollution degree III/2	8 kV
Rated impulse voltage for surge voltage class/ contamination degree III/3	8 kV		

Rated data acc. to CSA

Rated voltage (Use group B / CSA)	600 V	Rated voltage (Use group C / CSA)	600 V
Rated voltage (Use group D / CSA)	600 V	Rated current (Use group B / CSA)	37 A
Rated current (Use group C / CSA)	37 A	Rated current (Use group D / CSA)	5 A

Rated data acc. to UL 1059

Institute (cURus)		Certificate No. (cURus)	E60693
Rated voltage (Use group B / UL 1059)	600 V	Rated voltage (Use group C / UL 1059)	600 V
Rated voltage (Use group D / UL 1059)	600 V	Rated current (Use group B / UL 1059)	37 A
Rated current (Use group C / UL 1059)	37 A	Rated current (Use group D / UL 1059)	5 A
Wire cross-section, AWG, min.	AWG 24	Wire cross-section, AWG, max.	AWG 8
Reference to approval values	Specifications are maximum values, details - see approval certificate.		

Packing

Packaging	Box	VPE length	216 mm
VPE width	211 mm	VPE height	48 mm

Type tests

Test: Durability of markings	Test	mark of origin, type identification, type of material, pitch, durability
	Evaluation	available

LLFS 7.50/12/180V 5.0SN BK BX

Weidmüller Interfaces GmbH & Co. KG

Postfach 3030

32760 Detmold

Tel. +49 5231 14-0

Technische Daten

Fax. +49 5231 14-2083

IEC 60999-1 section 7 and 9.1 / 11.99, IEC 60947-1 section 8.2.1.5, IEC 603.11

info@weidmueller.com

www.weidmueller.com

Test: Clampable cross section

Standard

Conductor type

Type of conductor and conductor cross-section solid 0.5 mm²

Type of conductor and conductor cross-section stranded 0.5 mm²

Type of conductor and conductor cross-section solid 6 mm²

Type of conductor and conductor cross-section stranded 6 mm²

Type of conductor and conductor cross-section AWG 24/19

Type of conductor and conductor cross-section AWG 24/1

Type of conductor and conductor cross-section AWG 10/1

Type of conductor and conductor cross-section AWG 10/19

Type of conductor and conductor cross-section H07V-K10

Evaluation

passed

LLFS 7.50/12/180V 5.0SN BK BX

Weidmüller Interfaces GmbH & Co. KG

Postfach 3030

32760 Detmold

Tel. +49 5231 14-0

Technische Daten

Fax. +49 5231 14-2083

IEC 60999-1 section 9.4 / 11.99, IEC 60999-1 section 9.5 / 11.99

info@weidmueller.com

Test for damage to and accidental loosening of conductors

Standard	IEC 60999-1 section 9.4 / 11.99, IEC 60999-1 section 9.5 / 11.99	
Requirement	0.3 kg	
Conductor type	Type of conductor and conductor cross-section	H05V-K0.5
	Type of conductor and conductor cross-section	H05V-U0.5
Evaluation	passed	
Requirement	0.7 kg	
Conductor type	Type of conductor and conductor cross-section	H07V-K2.5
	Type of conductor and conductor cross-section	H07V-U2.5
Evaluation	passed	
Requirement	0.9 kg	
Conductor type	Type of conductor and conductor cross-section	H07V-K4
	Type of conductor and conductor cross-section	H07V-U4.0
Evaluation	passed	
Requirement	1.4 kg	
Conductor type	Type of conductor and conductor cross-section	H07V-K6
	Type of conductor and conductor cross-section	H07V-U6
Evaluation	passed	

LLFS 7.50/12/180V 5.0SN BK BX

Weidmüller Interfaces GmbH & Co. KG

Postfach 3030

32760 Detmold

Tel. +49 5231 14-0

Fax. +49 5231 14-2083

Technische Daten

Pull-out test	Standard	DIN EN 60999-1 section 9.5 / 12.00		
	Requirement	≥20 N info@weidmueller.com		
	Conductor type	Type of conductor and conductor cross-section	H05V-K0.5	info@weidmueller.com
		Type of conductor and conductor cross-section	H05V-U0.5	
	Evaluation	passed		
	Requirement	≥50 N		
	Conductor type	Type of conductor and conductor cross-section	H07V-K2.5	
		Type of conductor and conductor cross-section	H07V-U2.5	
	Evaluation	passed		
	Requirement	≥60 N		
	Conductor type	Type of conductor and conductor cross-section	H07V-K4	
		Type of conductor and conductor cross-section	H07V-U4.0	
	Evaluation	passed		
	Requirement	≥80 N		
	Conductor type	Type of conductor and conductor cross-section	H07V-K6	
		Type of conductor and conductor cross-section	H07V-U6	
	Evaluation	passed		

Classifications

ETIM 6.0	EC002643	ETIM 7.0	EC002643
ETIM 8.0	EC002643	ECLASS 9.0	27-44-04-01
ECLASS 9.1	27-44-04-01	ECLASS 10.0	27-44-04-01
ECLASS 11.0	27-46-01-01	ECLASS 12.0	27-46-01-01

LLFS 7.50/12/180V 5.0SN BK BX

Weidmüller Interfaces GmbH & Co. KG

Postfach 3030

32760 Detmold

Tel. +49 5231 14-0

Fax. +49 5231 14-2083

Technische Daten

info@weidmueller.com

www.weidmueller.com

Important note

IPC conformity Conformity: The products are developed, manufactured and delivered according international recognized standards and norms and comply with the assured properties in the data sheet resp. fulfill decorative properties in accordance with IPC-A-610 "Class 2". Further claims on the products can be evaluated on request.

- Notes
- Additional variants on request
 - Rated current related to rated cross-section & min. No. of poles.
 - Wire end ferrule without plastic collar to DIN 46228/1
 - Wire end ferrule with plastic collar to DIN 46228/4
 - P on drawing = pitch
 - Rated data refer only to the component itself. Clearance and creepage distances to other components are to be designed in accordance with the relevant application standards.
 - The test point can only be used as potential-pickup point.
 - The single-position PCB terminal block can be used for voltages up to 1500 V (DC) and 1000 V (AC). The relevant device standard and the appropriate required clearances and creepage distances should be observed in the application
 - Long term storage of the product with average temperature of 50 °C and average humidity 70%, 36 months

Approvals

Approvals



ROHS	Conform
UL File Number Search	UL Website
Certificate No. (cURus)	E60693

Downloads

Engineering Data	CAD data – STEP
Product Change Notification	20200806 Montageoptimierung LLFS 7.50180 20200806 Assembly optimization to LLFS 7.50180 20210909 Color Change of Actuator to LLF(S) and LUF(S) Family 20210909 LLF(S) und LUF(S) Familie - Farbänderung des Betätigungselementes
User Documentation	Assembly instruction Montageanleitung_LLFS_LUFS_EN_DE
Catalogues	Catalogues in PDF-format

LLFS 7.50/12/180V 5.0SN BK BX

Weidmüller Interfaces GmbH & Co. KG

Postfach 3030

32760 Detmold

Tel. +49 5231 14-0

Fax. +49 5231 14-2083

Zeichnungen

Product image

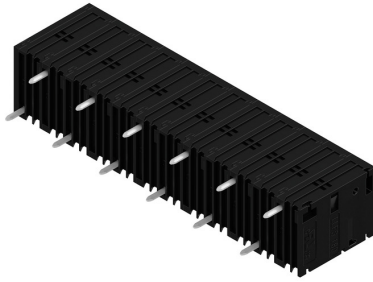

Dimensional drawing info@weidmueller.com

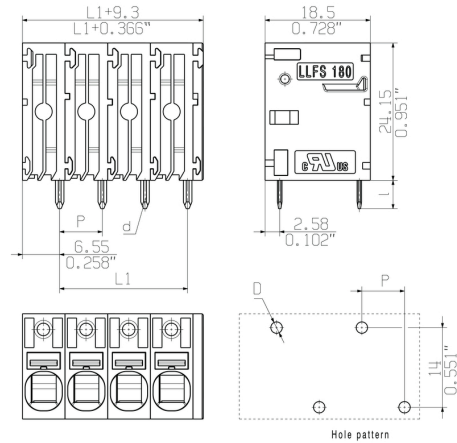

Derating curve

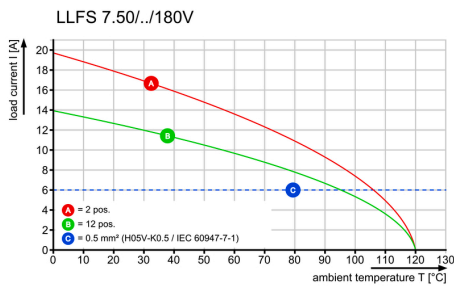

Derating curve

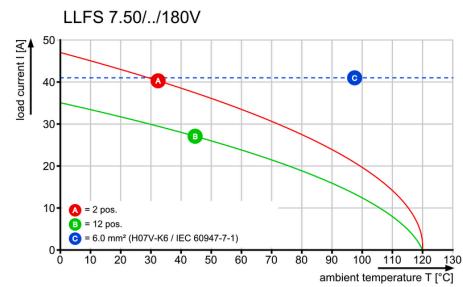

Product benefits

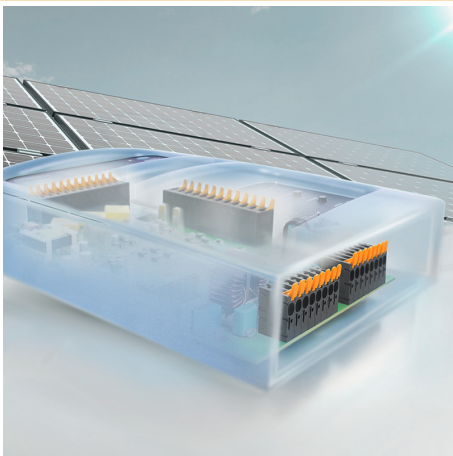

Power up to UL 600 V
Offset solder pins

Product benefits

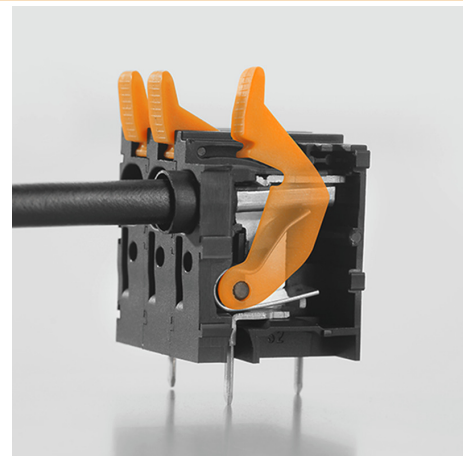

Tool-free wiring
Top contact security

General customer drawing, topical version only if required

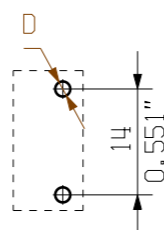
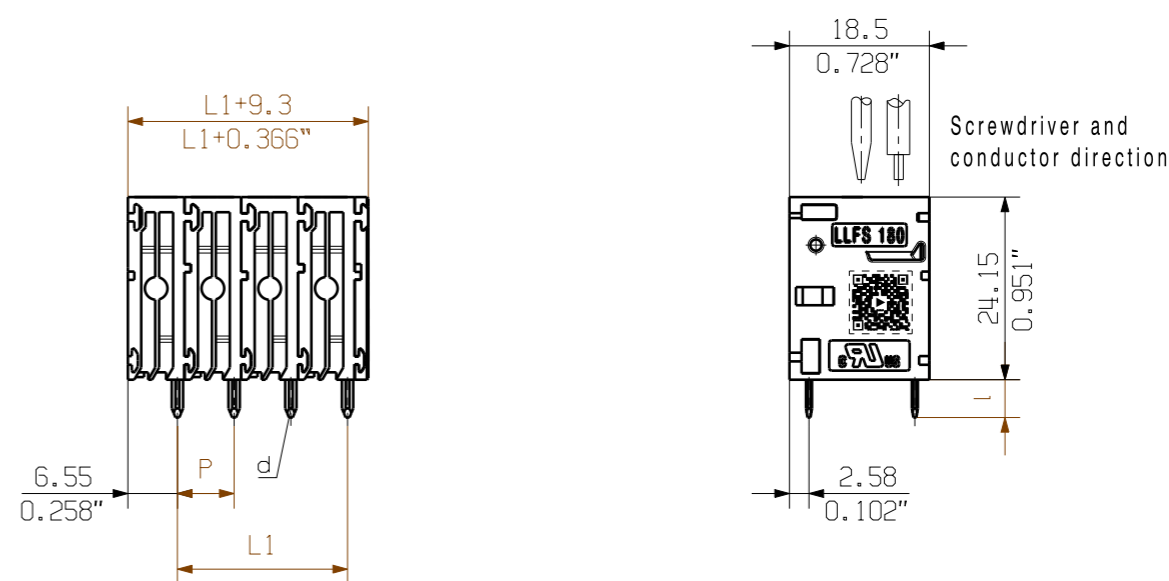
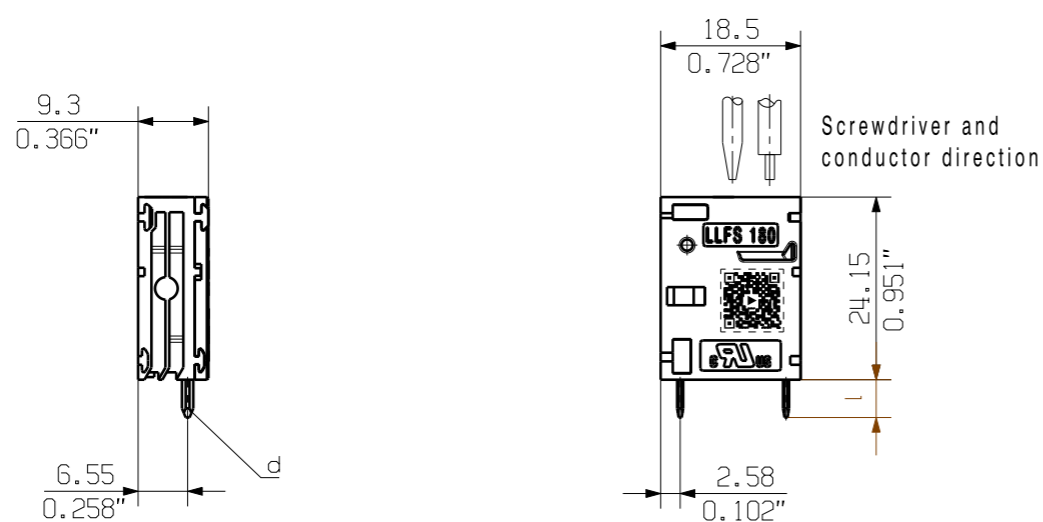

Hole pattern

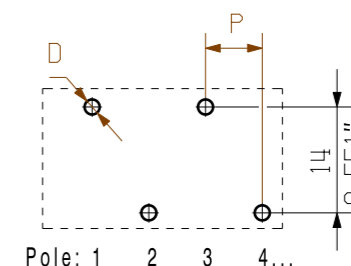
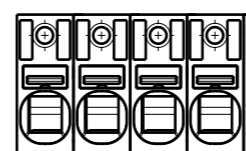

Hole pattern

Pole: 1 2 3 4...

Pole: 1 2 3 4...

For the mounting of PCBs, it should be noted that the rated data relates only to the PCB components alone. The necessary creepage and clearance paths must be observed in connection with the respective applicant in accordance to IEC 60664-1 (VDE 0110). The current-carrying capacity and pitch tolerance is to be determined according to DIN IEC 60326-3 very fine.

Weidmüller PCB components are tested to the IEC 60947-7-4 standard, and are valid for its field of application. Provided that the components are used to the intended purpose, all requirements with respect to the occurring of electrical, mechanical, thermic and corrosive stress will be satisfied.

General tolerance:
DIN ISO 2768-mK

P = 7.50
0.295" (Pitch)
D = Ø2 +0.1
0.079"
d = 1.5x0.8
0.059"x0.031"
l = 5.0 +0.2 -0.6
0.197"

12	82.50	3.248
11	75.00	2.953
10	67.50	2.657
9	60.00	2.362
8	52.50	2.067
7	45.00	1.772
6	37.50	1.476
5	30.00	1.181
4	22.50	0.886
3	15.00	0.591
2	7.50	0.295
n Poles	L1 [mm]	L1 [inch]

	EC00000693	01	Prim PLM Part No.: 337396		Prim ERP Part No.: 2491640000	
	First Issue Date	22.09.2016	Max. nos.			
Modification			64139 6 Drawing no. Issue no. Sheet 01 of 01 sheets			
	Drawn	28.04.2019	Date		Name	
	Responsible		Date		Name	
Approved	29.04.2019	Date		Name		
Scale: 1/1	Size: A3	Drawings Assembly		Product file: 7416 LLF 7.50		

LLFS 7.50/.../180 ...
LEITERPLATTENKLEMME
PCB TERMINAL

The reproduction, distribution and utilization of this document as well as the communication of its contents to others without explicit authorization is prohibited. Offenders will be held liable for the payment of damages. Weidmüller exclusively reserves the right to file for patents, utility models or designs. © Weidmüller Interface GmbH & Co. KG

Recommended wave soldering profiles

Weidmüller Interface GmbH & Co. KG
 Klängenbergstraße 16
 D-32758 Detmold
 Germany
 Fon: +49 5231 14-0
 Fax: +49 5231 14-292083
 www.weidmueller.com

Single Wave:



Double Wave:



Wave soldering profiles

Wired connection elements should be processed in accordance with the DIN EN 61760-1 standard. We have included two recommendations for practical wave soldering profiles, with which Weidmüller PCB terminals and connectors are qualified.

When choosing a suitable profile for your application, the following factors also need to be considered:

- PCB thickness
- Proportion of Cu in the layers
- Single/double-sided assembly
- Product range
- Heating and cooling rates

The single and double wave profiles each indicate the recommended operating range, including the maximum soldering temperature of 260°C. In practice, the maximum soldering temperature is quite often well below the above maximum profile.