

LL 10.00/02/90 3.2SN OR BX

Weidmüller Interface GmbH & Co. KG
 Klingenbergstraße 26
 D-32758 Detmold
 Germany

www.weidmueller.com

Product image

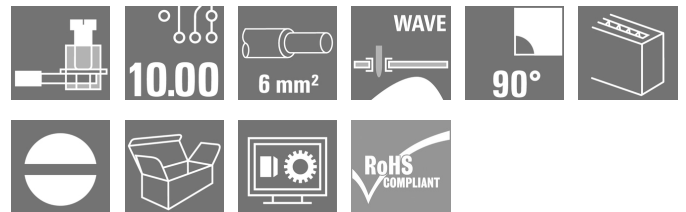

PCB terminal with proven clamping-yoke connection in 10 and 10.16 mm pitches, with 90° wire outlet angle. Suitable for conductor cross-sections up to 6.0 mm².

General ordering data

Version	Printed circuit board terminals, 10.00 mm, Number of poles: 2, 90°, Solder pin length (l): 3.2 mm, tinned, orange, Clamping yoke connection, Clamping range, max. : 6 mm ² , Box
Order No.	2613390000
Type	LL 10.00/02/90 3.2SN OR BX
GTIN (EAN)	4050118674750
Qty.	100 Stück
Product data	IEC: 1000 V / 32 A / 0.5 - 6 mm ² UL: 300 V / 30 A / AWG 26 - AWG 10
Packaging	Box

Erstellungs-Datum May 25, 2023 3:15:15 PM CEST

LL 10.00/02/90 3.2SN OR BX

Weidmüller Interface GmbH & Co. KG
 Klingenbergstraße 26
 D-32758 Detmold
 Germany

www.weidmueller.com

Technische Daten

Dimensions and weights

Depth	11 mm	Depth (inches)	0.433 inch
Height	20.3 mm	Height (inches)	0.799 inch
Height of lowest version	17.1 mm	Width	15 mm
Width (inches)	0.591 inch	Net weight	0.008 g

Temperatures

Operating temperature, min.	-50 °C	Operating temperature, max.	120 °C
-----------------------------	--------	-----------------------------	--------

System parameters

Product family	OMNIMATE Signal - series LL	Wire connection method	Clamping yoke connection
Property, clamping point	WireReady	Mounting onto the PCB	THT solder connection
Conductor outlet direction	90°	Pitch in mm (P)	10 mm
Pitch in inches (P)	0.394 inch	Number of poles	2
Pin series quantity	1	Fitted by customer	Yes
Number of rows	1	Max. adjacent poles per row	12
Solder pin length (l)	3.2 mm	Solder pin dimensions	0.75 x 0.9 mm
Solder eyelet hole diameter (D)	1.3 mm	Solder eyelet hole diameter tolerance (D)+	0, 1 mm
Number of solder pins per pole	1	Screwdriver blade	0.6 x 3.5
Screwdriver blade standard	DIN 5264	Tightening torque, min.	0.5 Nm
Tightening torque, max.	0.6 Nm	Clamping screw	M 3
Stripping length	6 mm	L1 in mm	10 mm
L1 in inches	0.394 inch	Protection degree	IP20

Material data

Insulating material	Wemid (PA)	Colour	orange
Colour chart (similar)	RAL 2000	Insulating material group	I
Comparative Tracking Index (CTI)	≥ 600	UL 94 flammability rating	V-0
Contact material	Copper alloy	Contact surface	tinned
Coating	4-6 µm SN	Tinning type	matt
Layer structure of solder connection	2...4 µm Ni / 4...6 µm Sn	Storage temperature, min.	-40 °C
Storage temperature, max.	70 °C	Operating temperature, min.	-50 °C
Operating temperature, max.	120 °C	Temperature range, installation, min.	-25 °C
Temperature range, installation, max.	120 °C		

Conductors suitable for connection

Clamping range, min.	0.13 mm ²	Clamping range, max.	6 mm ²
Wire connection cross section AWG, min.	AWG 26	Wire connection cross section AWG, max.	AWG 10
Solid, min. H05(07) V-U	0.5 mm ²	Solid, max. H05(07) V-U	6 mm ²
Flexible, min. H05(07) V-K	0.5 mm ²	Flexible, max. H05(07) V-K	4 mm ²
w. plastic collar ferrule, DIN 46228 pt 4, min.	0.5 mm ²	w. plastic collar ferrule, DIN 46228 pt 4, max.	2.5 mm ²
w. wire end ferrule, DIN 46228 pt 1, min.	0.5 mm ²	w. wire end ferrule, DIN 46228 pt 1, max.	2.5 mm ²
Plug gauge in accordance with EN 60999 a x b; ø		Reference text	Length of ferrules is to be chosen depending on the product and the rated voltage., The outside diameter of the plastic collar should not be larger than the pitch (P)
	2.8 mm x 2.4 mm; 3.0 mm		

Erstellungs-Datum May 25, 2023 3:15:15 PM CEST

LL 10.00/02/90 3.2SN OR BX

Weidmüller Interface GmbH & Co. KG
 Klingenbergstraße 26
 D-32758 Detmold
 Germany

www.weidmueller.com

Technische Daten

Rated data acc. to IEC

tested acc. to standard	IEC 60664-1, IEC 61984	Rated current, min. number of poles (Tu=20°C)	32 A
Rated current, max. number of poles (Tu=20°C)	32 A	Rated current, min. number of poles (Tu=40°C)	32 A
Rated current, max. number of poles (Tu=40°C)	30.5 A	Rated voltage for surge voltage class / pollution degree II/2	1,000 V
Rated voltage for surge voltage class / pollution degree III/2	630 V	Rated voltage for surge voltage class / pollution degree III/3	630 V
Rated impulse voltage for surge voltage class/ pollution degree II/2	1,000 V	Rated impulse voltage for surge voltage class/ pollution degree III/2	8 kV
Rated impulse voltage for surge voltage class/ contamination degree III/3	8 kV	Short-time withstand current resistance	3 x 1s with 120 A

Rated data acc. to CSA

Institute (CSA)		Certificate No. (CSA)	200039-1202191
Rated voltage (Use group B / CSA)	300 V	Rated voltage (Use group D / CSA)	300 V
Rated current (Use group B / CSA)	30 A	Rated current (Use group D / CSA)	10 A
Wire cross-section, AWG, min.	AWG 26	Wire cross-section, AWG, max.	AWG 10
Reference to approval values	Specifications are maximum values, details - see approval certificate.		

Rated data acc. to UL 1059

Institute (UR)		Certificate No. (UR)	E60693
Rated voltage (Use group B / UL 1059)	300 V	Rated voltage (Use group C / UL 1059)	150 V
Rated voltage (Use group D / UL 1059)	300 V	Rated current (Use group B / UL 1059)	30 A
Rated current (Use group D / UL 1059)	10 A	Wire cross-section, AWG, min.	AWG 26
Wire cross-section, AWG, max.	AWG 10	Reference to approval values	Specifications are maximum values, details - see approval certificate.

Packing

Packaging	Box	VPE length	338 mm
VPE width	130 mm	VPE height	27 mm

Classifications

ETIM 6.0	EC002643	ETIM 7.0	EC002643
ETIM 8.0	EC002643	ECLASS 9.0	27-44-04-01
ECLASS 9.1	27-44-04-01	ECLASS 10.0	27-44-04-01
ECLASS 11.0	27-46-01-01	ECLASS 12.0	27-46-01-01

LL 10.00/02/90 3.2SN OR BX

Weidmüller Interface GmbH & Co. KG
Klingenbergstraße 26
D-32758 Detmold
Germany

www.weidmueller.com

Technische Daten

Important note

IPC conformity	Conformity: The products are developed, manufactured and delivered according international recognized standards and norms and comply with the assured properties in the data sheet resp. fulfill decorative properties in accordance with IPC-A-610 "Class 2". Further claims on the products can be evaluated on request.
Notes	<ul style="list-style-type: none">• Long term storage of the product with average temperature of 50 °C and average humidity 70%, 36 months

Approvals

Approvals



UL File Number Search	UL Website
Certificate No. (UR)	E60693

Downloads

Engineering Data	CAD data – STEP
Catalogues	Catalogues in PDF-format

LL 10.00/02/90 3.2SN OR BX

Weidmüller Interface GmbH & Co. KG
 Klingenbergstraße 26
 D-32758 Detmold
 Germany

www.weidmueller.com

Zeichnungen

Product image

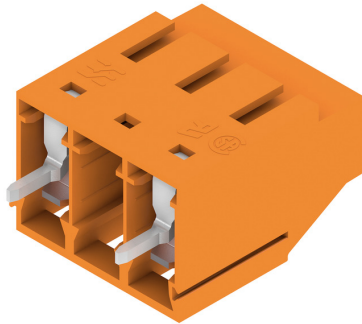

Dimensional drawing

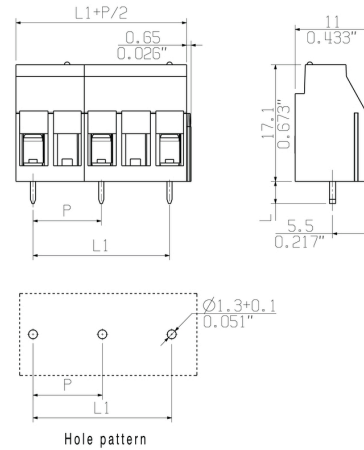

Recommended wave soldering profiles

Weidmüller Interface GmbH & Co. KG
 Klängenbergstraße 16
 D-32758 Detmold
 Germany
 Fon: +49 5231 14-0
 Fax: +49 5231 14-292083
 www.weidmueller.com

Single Wave:



Double Wave:



Wave soldering profiles

Wired connection elements should be processed in accordance with the DIN EN 61760-1 standard. We have included two recommendations for practical wave soldering profiles, with which Weidmüller PCB terminals and connectors are qualified.

When choosing a suitable profile for your application, the following factors also need to be considered:

- PCB thickness
- Proportion of Cu in the layers
- Single/double-sided assembly
- Product range
- Heating and cooling rates

The single and double wave profiles each indicate the recommended operating range, including the maximum soldering temperature of 260°C. In practice, the maximum soldering temperature is quite often well below the above maximum profile.