

TRP 12VDC 1CO EMPTY

Weidmüller Interface GmbH & Co. KG
 Klingenbergstraße 26
 D-32758 Detmold
 Germany

www.weidmueller.com

Product image

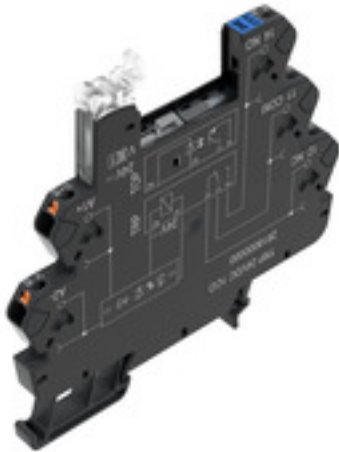

Similar to illustration

TERMSERIES empty sockets with:

- 1 CO contact
- Unique multi-voltage input from 24 to 230 V UC
- Input voltages with coloured marking: DC: blue, UC: white
- Due to high-quality design and no sharp edges no risk of injuries during installation
- Partition plates for optical separation and reinforcement of insulation

General ordering data

Version	TERMSERIES, Relay socket, Number of contacts: 1, CO contact, Rated control voltage: 12 V DC \pm 20 %, Continuous current: 10 A, PUSH IN
Order No.	2618930000
Type	TRP 12VDC 1CO EMPTY
GTIN (EAN)	4050118669909
Qty.	10 Stück

Erstellungs-Datum May 26, 2023 9:04:01 AM CEST

Katalogstand 12.05.2023 / Technische Änderungen vorbehalten

TRP 12VDC 1CO EMPTY

Weidmüller Interface GmbH & Co. KG
 Klingenbergstraße 26
 D-32758 Detmold
 Germany

www.weidmueller.com

Technische Daten

Dimensions and weights

Depth	87.8 mm	Depth (inches)	3.457 inch
Height	89.6 mm	Height (inches)	3.528 inch
Width	6.4 mm	Width (inches)	0.252 inch
Net weight	19.7 g		

Temperatures

Storage temperature	-40 °C...85 °C	Operating temperature	-40 °C...60 °C
Operating temperature, min.	-40 °C	Operating temperature, max.	60 °C
Humidity	5-95% relative humidity, T _u = 40°C, without condensation		

Rated data UL

Ambient temperature (operational), max. 60 °C		Connection cross-section AWG, min.	AWG 26
Connection cross-section AWG, max.	AWG 14	Type of conductor	rigid copper conductor, flexible copper conductor
Pollution severity level	2	Certificate No. (cURus)	E223759

Control side

Rated control voltage	12 V DC ±20 %	Status indicator	Green LED
-----------------------	---------------	------------------	-----------

Load side

Rated switching voltage	250 V AC	Continuous current	10 A
Max. switching voltage, AC	250 V	Max. switching voltage, DC	250 V
Contact type	1 CO contact		

General data

Operating altitude	≤ 2000 m, above sea level		
Rail	TS 35		
Colour	black		
UL94 flammability rating component	Component	Housing	
	UL94 flammability rating	V-0	
	Component	Retaining clip	
	UL94 flammability rating	V-0	
	Component	Pusher	
	UL94 flammability rating	V-0	

Insulation coordination

Rated voltage	300 V	Pollution severity	2
Surge voltage category	III	Dielectric strength to mounting rail	4 kV _{eff} / 1 Min.
Impulse withstand voltage	6 kV (1.2/50 μs)	Protection degree	IP20

Further details of approvals / standards

Certificate No. (cURus)	E223759
-------------------------	---------

TRP 12VDC 1CO EMPTY

Weidmüller Interface GmbH & Co. KG
 Klingenbergstraße 26
 D-32758 Detmold
 Germany

www.weidmueller.com

Technische Daten

Connection data

Wire connection method	PUSH IN	Stripping length, rated connection	9 mm
Clamping range, rated connection	1.5 mm ²	Clamping range, min.	0.14 mm ²
Clamping range, max.	2.5 mm ²	Wire connection cross section AWG, min.	AWG 26
Wire connection cross section AWG, max.	AWG 14	Wire cross-section, solid, min.	0.14 mm ²
Wire cross-section, solid, max.	1.5 mm ²	Wire cross-section, solid, min. (AWG)	AWG 26
Wire cross-section, solid, max. (AWG)	AWG 16	Wire connection cross section, finely stranded, min.	0.14 mm ²
Wire connection cross section, finely stranded, max.	2.5 mm ²	Wire cross-section, finely stranded, min. (AWG)	AWG 26
Wire cross-section, finely stranded, max. (AWG)	AWG 14	Wire connection cross-section, finely stranded with wire-end ferrules DIN 46228/4, min.	0.15 mm ²
Wire connection cross-section, finely stranded with wire-end ferrules DIN 46228/4, max.	1.5 mm ²	Conductor cross-section, flexible, AEH (DIN 46228-1), min.	0.15 mm ²
Conductor cross-section, flexible, AEH (DIN 46228-1), max.	1.5 mm ²	Twin wire-end ferrules, min.	0.5 mm ²
Twin wire-end ferrules, max.	1 mm ²	Blade size	0.4 x 2.0 mm

Classifications

ETIM 6.0	EC001456	ETIM 7.0	EC001456
ETIM 8.0	EC001456	ECLASS 9.0	27-37-16-03
ECLASS 9.1	27-37-16-03	ECLASS 10.0	27-37-16-03
ECLASS 11.0	27-37-16-03	ECLASS 12.0	27-37-16-03

Environmental Product Compliance

REACH SVHC	Lead 7439-92-1
SCIP	9e2cbc49-76d9-4611-b8ec-5b4f549a0aa9

Approvals

Approvals



ROHS	Conform
UL File Number Search	UL Website
Certificate No. (cURus)	E223759

Downloads

Approval/Certificate/Document of Conformity	EU Konformitätserklärung / EU Declaration of Conformity
Engineering Data	CAD data – STEP
Engineering Data	EPLAN
User Documentation	Beipackzettel / Package Insert – multilingual
Catalogues	Catalogues in PDF-format

TRP 12VDC 1CO EMPTY

Weidmüller Interface GmbH & Co. KG
Klingenbergstraße 26
D-32758 Detmold
Germany

www.weidmueller.com

Zeichnungen

Wiring diagram

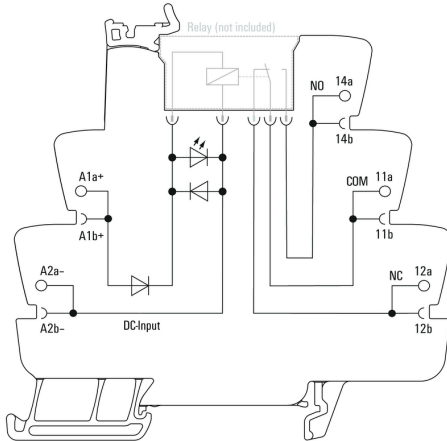

Dimensional drawing

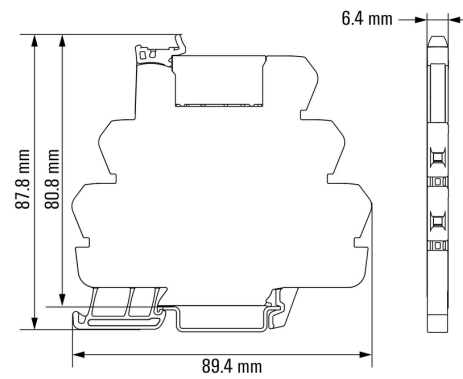

TRP 12VDC 1CO EMPTY

Weidmüller Interface GmbH & Co. KG
 Klingenbergstraße 26
 D-32758 Detmold
 Germany

www.weidmueller.com

Zeichnungen

Miscellaneous

Type code TERMSERIES empty sockets

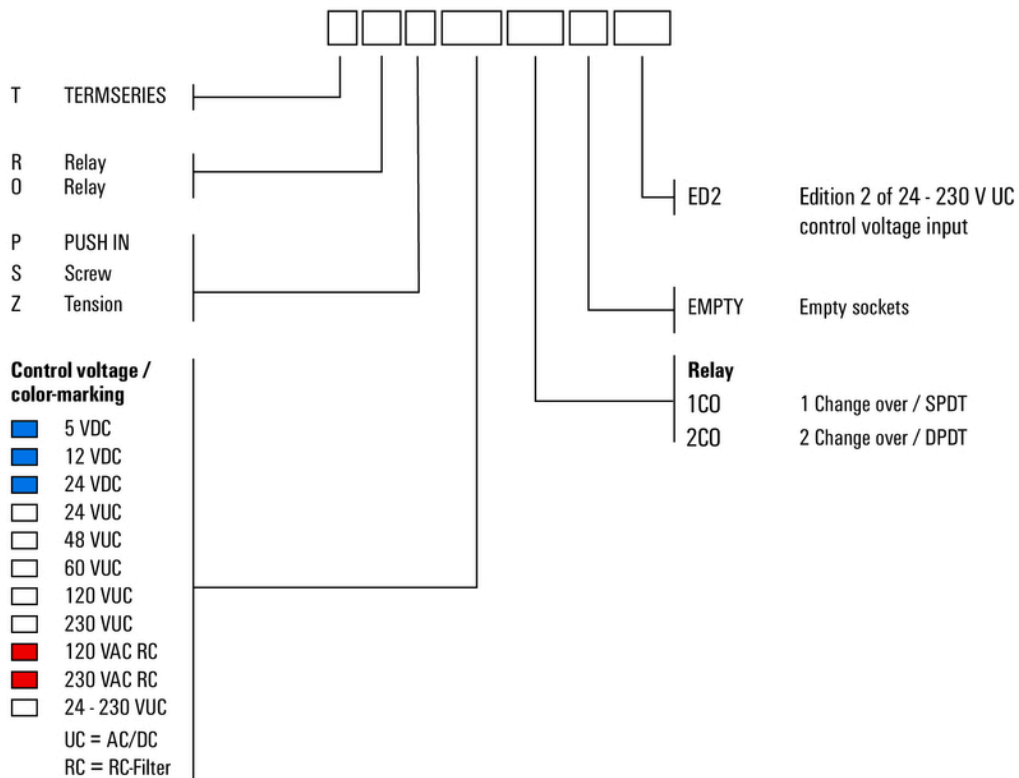

Type codes