

TCS 3.81/09/90 3.5SN GN BX

Weidmüller Interface GmbH & Co. KG
Klingenbergstraße 26
D-32758 Detmold
Germany

www.weidmueller.com

**General ordering data**

Order No.	2650500000
Type	TCS 3.81/09/90 3.5SN GN BX
GTIN (EAN)	4050118636475
Qty.	192 Stück
Product data	IEC: 320 V / 10 A / 0.2 - 1.5 mm ² UL: 150 V / 10 A / AWG 26 - AWG 16
Packaging	Box

Erstellungs-Datum May 26, 2023 1:35:10 PM CEST

Katalogstand 12.05.2023 / Technische Änderungen vorbehalten

TCS 3.81/09/90 3.5SN GN BX

Weidmüller Interface GmbH & Co. KG
 Klingenbergstraße 26
 D-32758 Detmold
 Germany

www.weidmueller.com

Technische Daten

Dimensions and weights

Net weight 4.14 g

Temperatures

Operating temperature, min. -40 °C Operating temperature, max. 105 °C

System parameters

Product family	OMNIMATE basic – Series TCS	Wire connection method	Clamping yoke connection
Mounting onto the PCB	THT solder connection	Conductor outlet direction	90°
Pitch in mm (P)	3.81 mm	Pitch in inches (P)	0.15 inch
Number of poles	9	Pin series quantity	1
Number of rows	1	Solder pin length (l)	3.5 mm
Solder pin dimensions	0.5 x 0.9mm	Solder eyelet hole diameter (D)	1.3 mm
Number of solder pins per pole	1	Screwdriver blade	0.4 x 2.5
Tightening torque, min.	0.2 Nm	Tightening torque, max.	0.23 Nm
Clamping screw	M 2	Stripping length	5 mm
L1 in mm	30.48 mm	L1 in inches	1.2 inch
Protection degree	IP20		

Material data

Insulating material	PA	Colour	Pale green
Colour chart (similar)	RAL 6021	Insulating material group	I
UL 94 flammability rating	V-0	Contact material	Copper alloy
Contact surface	tinned	Tinning type	matt
Storage temperature, min.	-40 °C	Storage temperature, max.	70 °C
Operating temperature, min.	-40 °C	Operating temperature, max.	105 °C

Conductors suitable for connection

Clamping range, min.	0.2 mm ²	Clamping range, max.	1.5 mm ²
Wire connection cross section AWG, min.	AWG 26	Wire connection cross section AWG, max.	AWG 16
Solid, min. H05(07) V-U	0.2 mm ²	Solid, max. H05(07) V-U	1.5 mm ²
Flexible, min. H05(07) V-K	0.2 mm ²	Flexible, max. H05(07) V-K	1 mm ²
w. plastic collar ferrule, DIN 46228 pt 4, min.	0.25 mm ²	w. plastic collar ferrule, DIN 46228 pt 4, max.	1 mm ²
w. wire end ferrule, DIN 46228 pt 1, min.	0.25 mm ²	w. wire end ferrule, DIN 46228 pt 1, max.	1 mm ²

Rated data acc. to IEC

Rated current, min. number of poles (Tu=20°C)	10 A	Rated voltage for surge voltage class / pollution degree II/2	320 V
Rated voltage for surge voltage class / pollution degree III/2	250 V	Rated voltage for surge voltage class / pollution degree III/3	160 V
Rated impulse voltage for surge voltage class/ pollution degree II/2	2.5 kV	Rated impulse voltage for surge voltage class/ pollution degree III/2	2.5 kV
Rated impulse voltage for surge voltage class/ contamination degree III/3	2.5 kV		

TCS 3.81/09/90 3.5SN GN BX

Weidmüller Interface GmbH & Co. KG
 Klingenbergstraße 26
 D-32758 Detmold
 Germany

www.weidmueller.com

Technische Daten

Rated data acc. to CSA

Rated voltage (Use group B / CSA)	150 V	Rated current (Use group B / CSA)	10 A
Wire cross-section, AWG, min.	AWG 26	Wire cross-section, AWG, max.	AWG 16

Rated data acc. to UL 1059

Institute (cURus)		Certificate No. (cURus)	E60693
Rated voltage (Use group B / UL 1059)	150 V	Rated current (Use group B / UL 1059)	10 A
Wire cross-section, AWG, min.	AWG 26	Wire cross-section, AWG, max.	AWG 16
Reference to approval values	Specifications are maximum values, details - see approval certificate.		

Packing

Packaging	Box	VPE length	168 mm
VPE width	133 mm	VPE height	47 mm

Classifications

ETIM 6.0	EC002643	ETIM 7.0	EC002643
ETIM 8.0	EC002643	ECLASS 9.0	27-44-04-01
ECLASS 9.1	27-44-04-01	ECLASS 10.0	27-44-04-01
ECLASS 11.0	27-46-01-01	ECLASS 12.0	27-46-01-01

Environmental Product Compliance

REACH SVHC	Lead 7439-92-1
SCIP	e8ca8b50-189f-4e0d-bdaa-5c8b34abe5bd

Important note

- Notes
- Only compatible with OMNIMATE basic products
 - P on drawing = pitch
 - Rated current related to rated cross-section & min. No. of poles.
 - Rated data refer only to the component itself. Clearance and creepage distances to other components are to be designed in accordance with the relevant application standards.
 - In the case of a two-pole terminal, the insulating body must be held against the terminal when tightening the screw.
 - Long term storage of the product with average temperature of 50 °C and average humidity 70%, 36 months

TCS 3.81/09/90 3.5SN GN BX

Weidmüller Interface GmbH & Co. KG
Klingenbergstraße 26
D-32758 Detmold
Germany

www.weidmueller.com

Technische Daten

Approvals

Approvals



ROHS Conform

UL File Number Search [UL Website](#)

Certificate No. (cURus) E60693

Downloads

Catalogues [Catalogues in PDF-format](#)

TCS 3.81/09/90 3.5SN GN BX

Weidmüller Interface GmbH & Co. KG
Klingenbergstraße 26
D-32758 Detmold
Germany

Zeichnungen

www.weidmueller.com

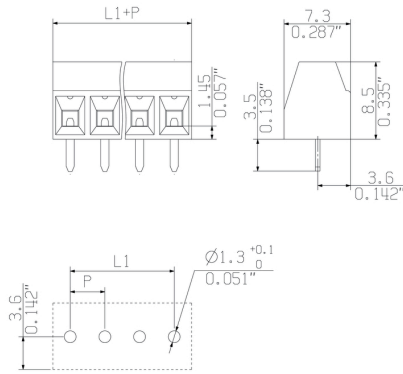

Recommended wave soldering profiles

Weidmüller Interface GmbH & Co. KG
 Klängenbergstraße 16
 D-32758 Detmold
 Germany
 Fon: +49 5231 14-0
 Fax: +49 5231 14-292083
 www.weidmueller.com

Single Wave:



Double Wave:



Wave soldering profiles

Wired connection elements should be processed in accordance with the DIN EN 61760-1 standard. We have included two recommendations for practical wave soldering profiles, with which Weidmüller PCB terminals and connectors are qualified.

When choosing a suitable profile for your application, the following factors also need to be considered:

- PCB thickness
- Proportion of Cu in the layers
- Single/double-sided assembly
- Product range
- Heating and cooling rates

The single and double wave profiles each indicate the recommended operating range, including the maximum soldering temperature of 260°C. In practice, the maximum soldering temperature is quite often well below the above maximum profile.