

DRM270012L

Weidmüller Interface GmbH & Co. KG
 Klingenbergstraße 26
 D-32758 Detmold
 Germany

www.weidmueller.com

Product image



Similar to illustration

Individual relays within the D-SERIES DRM

- 2 CO contacts
- AC coils
- With integrated status LED

General ordering data

| | |
|------------|--|
| Version | D-SERIES DRM, Relay, Number of contacts: 2, CO contact, AgNi flash gold-plated, Rated control voltage: 12 V DC, Continuous current: 10 A, Plug-in connection |
| Order No. | 7760056059 |
| Type | DRM270012L |
| GTIN (EAN) | 4032248855964 |
| Qty. | 20 Stück |

Erstellungs-Datum June 1, 2023 10:59:03 AM CEST

Katalogstand 26.05.2023 / Technische Änderungen vorbehalten

DRM270012L

Weidmüller Interface GmbH & Co. KG

Klingenbergstraße 26

D-32758 Detmold

Germany

www.weidmueller.com

Technische Daten

Dimensions and weights

| | | | |
|------------|---------|-----------------|------------|
| Depth | 35.7 mm | Depth (inches) | 1.406 inch |
| Height | 27.4 mm | Height (inches) | 1.079 inch |
| Width | 21 mm | Width (inches) | 0.827 inch |
| Net weight | 35.3 g | | |

Temperatures

| | | | |
|-----------------------------|--|-----------------------------|----------------|
| Storage temperature | -40 °C...70 °C | Operating temperature | -40 °C...60 °C |
| Operating temperature, min. | -40 °C | Operating temperature, max. | 60 °C |
| Humidity | 35...85 % rel. humidity, no condensation | | |

Rated data UL

| | |
|-------------------------|---------|
| Certificate No. (cURus) | E312083 |
|-------------------------|---------|

Control side

| | | | |
|-----------------------|--------------|--------------------------------|----------------|
| Rated control voltage | 12 V DC | Rated current DC | 75 mA |
| Power rating | 0.9 W | Pull-in/drop-out voltage, typ. | 9 V / 1.2 V DC |
| Coil resistance | 160 Ω ± 10 % | Coil tolerance | 10 % |
| Status indicator | Green LED | | |

Load side

| | | | |
|---|---------------------------------------|---|---------------------------------------|
| Rated switching voltage | 250 V AC | Continuous current | 10 A |
| Max. switching frequency at rated load | 0.1 Hz | Inrush current | 20 A / 50 ms |
| AC switching capacity (resistive), max. | 2500 VA | DC switching capacity (resistive), max. | 240 W @ 24 V |
| Switch-on delay | < 20 ms | Switch-off delay | < 20 ms |
| Contact type | 2 CO contact (AgNi flash gold-plated) | Mechanical service life | 20 x 10 ⁶ switching cycles |
| Min. switching power | 10 mA @ 12 V, 100 mA @ 5 V | | |

General data

| | | |
|--------------------------------------|--------------------------|-----------------|
| Test button available | No | |
| Mechanical switch position indicator | Yes | |
| Colour | Transparent | |
| UL94 flammability rating component | Component | Relay cover |
| | UL94 flammability rating | V-2 |
| | Component | Relay baseplate |
| | UL94 flammability rating | V-0 |
| Component | Relay status indicator | |
| | UL94 flammability rating | HB |

Insulation coordination

| | | | |
|--|--------------------------------|---|-----------------------------|
| Rated voltage | 250 V | Pollution severity | 2 |
| Surge voltage category | III | Clearance and creepage distances for control side - load side | ≥ 5.5 mm |
| Dielectric strength for control side - load side | 1.8 kV _{eff} / 1 min. | Dielectric strength of neighbouring contacts | 1 kV _{eff} / 1 min |
| Dielectric strength of open contact | 1 kV _{eff} / 1 min | Impulse withstand voltage | 6 kV (1.2/50 μs) |
| Protection degree | IP20 | | |

Erstellungs-Datum June 1, 2023 10:59:03 AM CEST

DRM270012L

Weidmüller Interface GmbH & Co. KG
 Klingenbergstraße 26
 D-32758 Detmold
 Germany

www.weidmueller.com

Technische Daten

Further details of approvals / standards

Certificate No. (cURus) E312083

Connection data

Wire connection method Plug-in connection

Classifications

| | | | |
|-------------|-------------|-------------|-------------|
| ETIM 6.0 | EC001437 | ETIM 7.0 | EC001437 |
| ETIM 8.0 | EC001437 | ECLASS 9.0 | 27-37-16-01 |
| ECLASS 9.1 | 27-37-16-01 | ECLASS 10.0 | 27-37-16-01 |
| ECLASS 11.0 | 27-37-16-01 | ECLASS 12.0 | 27-37-16-01 |

Environmental Product Compliance

REACH SVHC Lead 7439-92-1

Approvals

Approvals



ROHS Conform

UL File Number Search UL Website

Certificate No. (cURus) E312083

Downloads

| | |
|---|--|
| Approval/Certificate/Document of Conformity | EU Konformitätserklärung / EU Declaration of Conformity |
| Engineering Data | CAD data – STEP |
| Engineering Data | WSCAD, EPLAN |
| Product Change Notification | 20230124 Product consolidation D-SERIES DRM relays 20230124 Produktkonsolidierung D-SERIES DRM Relais |
| Catalogues | Catalogues in PDF-format |
| Brochures | |

Zeichnungen

Wiring diagram

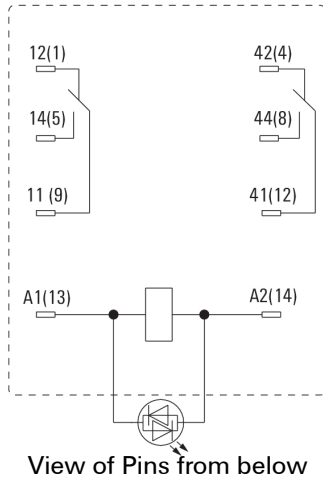

Graph

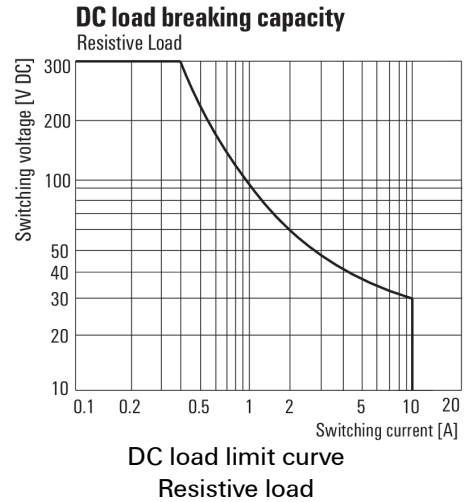

Graph

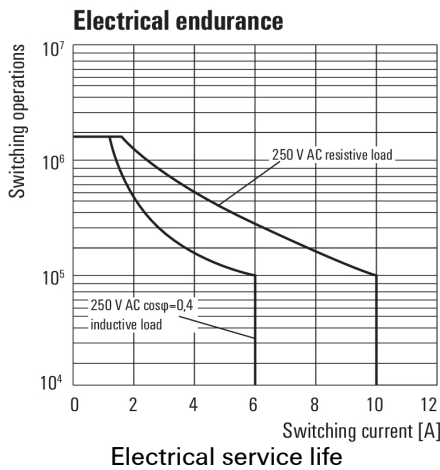

Graph

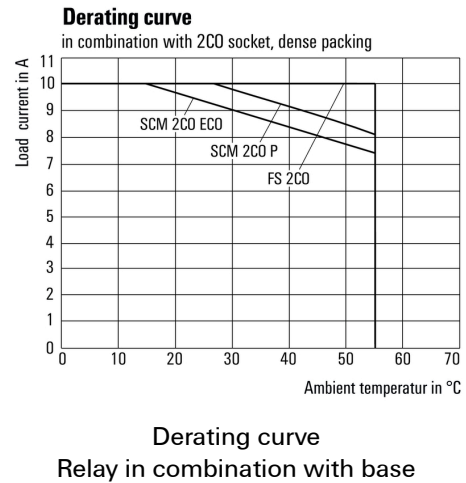

Graph

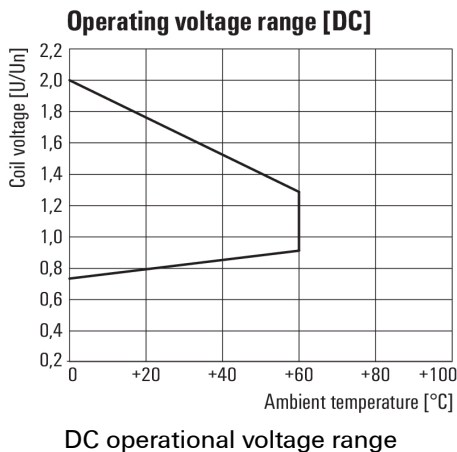

Dimensional drawing

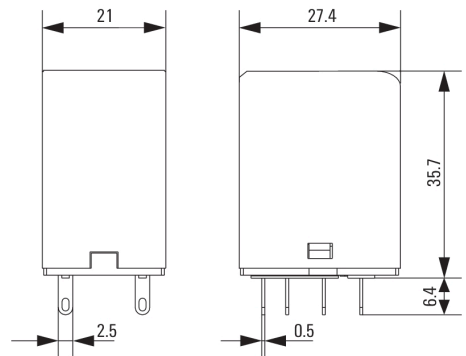

DRM270012L

Weidmüller Interface GmbH & Co. KG
 Klingenbergstraße 26
 D-32758 Detmold
 Germany

www.weidmueller.com

Zeichnungen

Miscellaneous

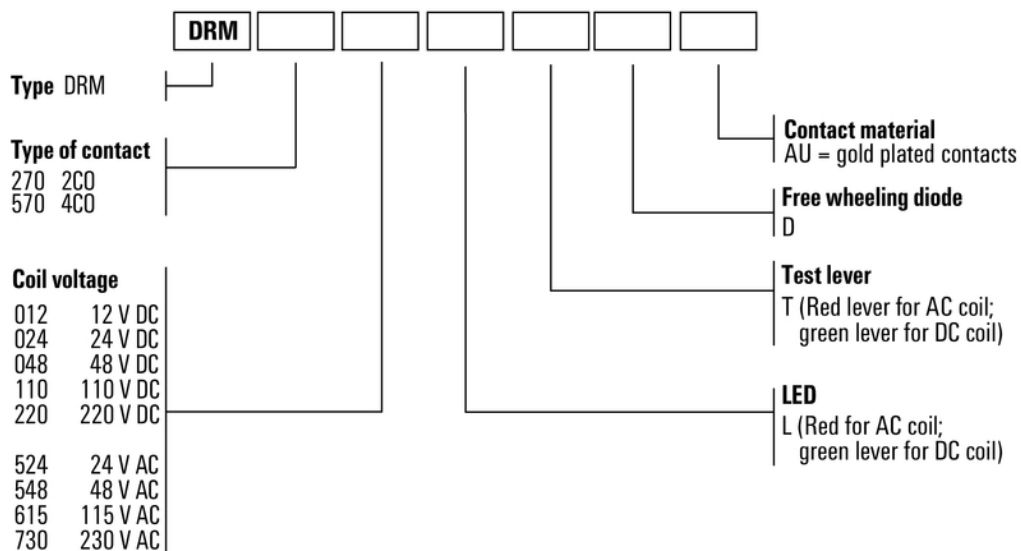

Type codes