

## DRM270548L

**Weidmüller Interface GmbH & Co. KG**

Klingenbergstraße 26

D-32758 Detmold

Germany

www.weidmueller.com

### Product image



Similar to illustration

Individual relays within the D-SERIES DRM

- 2 CO contacts
- AC coils
- With integrated status LED

### General ordering data

Version	D-SERIES DRM, Relay, Number of contacts: 2, CO contact, AgNi flash gold-plated, Rated control voltage: 48 V AC, Continuous current: 10 A, Plug-in connection
Order No.	<a href="#">7760056065</a>
Type	DRM270548L
GTIN (EAN)	4032248855902
Qty.	20 Stück

Erstellungs-Datum June 1, 2023 11:00:05 AM CEST

Katalogstand 26.05.2023 / Technische Änderungen vorbehalten

**DRM270548L**

**Weidmüller Interface GmbH & Co. KG**  
 Klingenbergstraße 26  
 D-32758 Detmold  
 Germany

www.weidmueller.com

## Technische Daten

### Dimensions and weights

Depth	35.7 mm	Depth (inches)	1.406 inch
Height	27.4 mm	Height (inches)	1.079 inch
Width	21 mm	Width (inches)	0.827 inch
Net weight	35.3 g		

### Temperatures

Storage temperature	-40 °C...70 °C	Operating temperature	-40 °C...55 °C
Operating temperature, min.	-40 °C	Operating temperature, max.	55 °C
Humidity	35...85 % rel. humidity, no condensation		

### Rated data UL

Certificate No. (cURus)	E312083
-------------------------	---------

### Control side

Rated control voltage	48 V AC	Rated current AC	33.3 mA (50 Hz), 27.8 mA (60 Hz)
Power rating	1.0...1.2VA (60HZ)	Pull-in/drop-out voltage, typ.	38.4 V / 14.4 V AC
Coil resistance	600 Ω ± 10 %	Coil tolerance	10 %
Status indicator	red LED		

### Load side

Rated switching voltage	250 V AC	Continuous current	10 A
Max. switching frequency at rated load	0.1 Hz	Inrush current	20 A / 50 ms
AC switching capacity (resistive), max.	2500 VA	DC switching capacity (resistive), max.	240 W @ 24 V
Switch-on delay	< 20 ms	Switch-off delay	< 20 ms
Contact type	2 CO contact (AgNi flash gold-plated)	Mechanical service life	20 x 10 <sup>6</sup> switching cycles
Min. switching power	10 mA @ 12 V, 100 mA @ 5 V		

### General data

Test button available	No	
Mechanical switch position indicator	Yes	
Colour	Transparent	
UL94 flammability rating component	Component	Relay cover
	UL94 flammability rating	V-2
	Component	Relay baseplate
	UL94 flammability rating	V-0
	Component	Relay status indicator
	UL94 flammability rating	HB

**DRM270548L**

**Weidmüller Interface GmbH & Co. KG**  
 Klingenbergstraße 26  
 D-32758 Detmold  
 Germany

www.weidmueller.com

## Technische Daten

### Insulation coordination

Rated voltage	250 V	Pollution severity	2
Surge voltage category	III	Clearance and creepage distances for control side - load side	≥ 5.5 mm
Dielectric strength for control side - load side	1.8 kV <sub>eff</sub> / 1 min.	Dielectric strength of neighbouring contacts	1 kV <sub>eff</sub> / 1 min
Dielectric strength of open contact	1 kV <sub>eff</sub> / 1 min	Impulse withstand voltage	6 kV (1.2/50 μs)
Protection degree	IP20		

### Further details of approvals / standards

Certificate No. (cURus)	E312083
-------------------------	---------

### Connection data

Wire connection method	Plug-in connection
------------------------	--------------------

### Classifications

ETIM 6.0	EC001437	ETIM 7.0	EC001437
ETIM 8.0	EC001437	ECLASS 9.0	27-37-16-01
ECLASS 9.1	27-37-16-01	ECLASS 10.0	27-37-16-01
ECLASS 11.0	27-37-16-01	ECLASS 12.0	27-37-16-01

### Environmental Product Compliance

REACH SVHC	Lead 7439-92-1
------------	----------------

### Approvals

Approvals



ROHS	Conform
UL File Number Search	UL Website
Certificate No. (cURus)	E312083

### Downloads

Approval/Certificate/Document of Conformity	<a href="#">EU Konformitätserklärung / EU Declaration of Conformity</a>
Engineering Data	<a href="#">CAD data – STEP</a>
Engineering Data	<a href="#">WSCAD, EPLAN</a>
Product Change Notification	<a href="#">20230124 Product consolidation D-SERIES DRM relays</a> <a href="#">20230124 Produktkonsolidierung D-SERIES DRM Relais</a>
Catalogues	<a href="#">Catalogues in PDF-format</a>
Brochures	

Zeichnungen

Wiring diagram

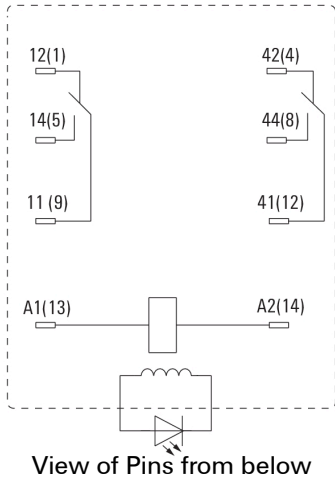

Graph

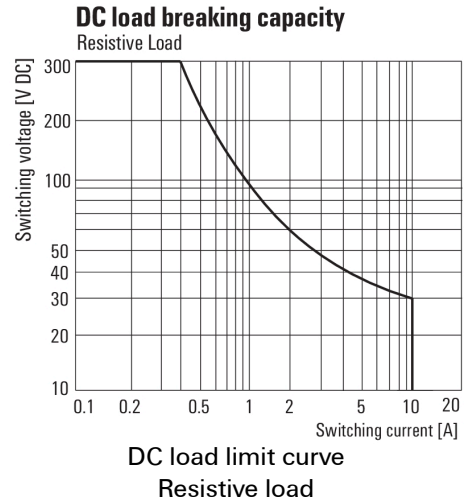

Graph

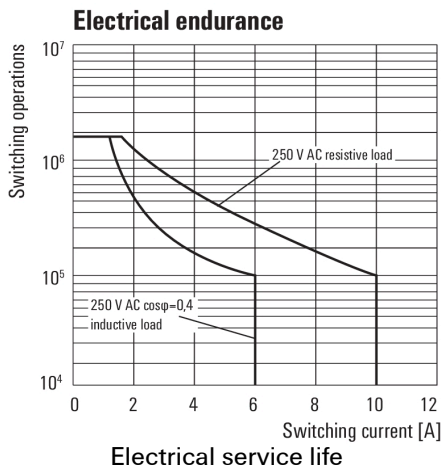

Graph

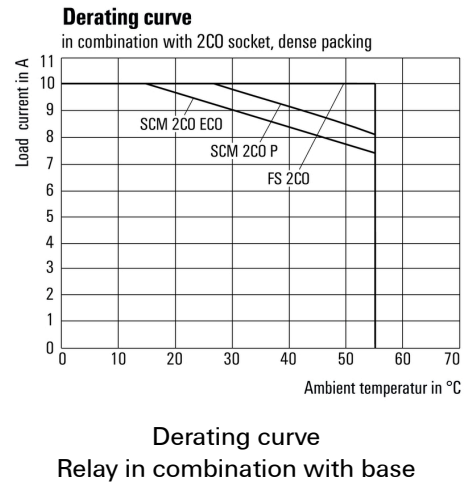

Graph

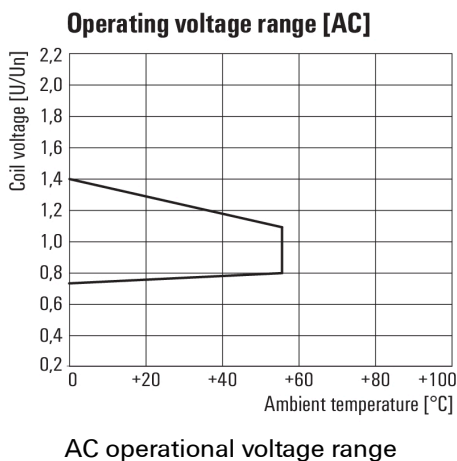

Dimensional drawing

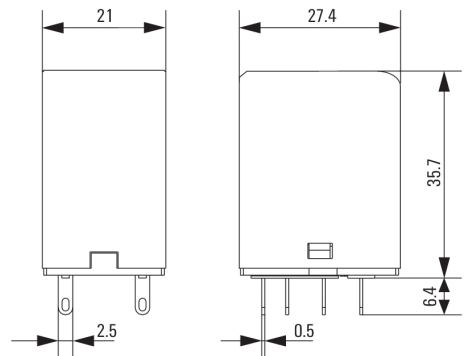

## DRM270548L

**Weidmüller Interface GmbH & Co. KG**  
 Klingenbergstraße 26  
 D-32758 Detmold  
 Germany

www.weidmueller.com

## Zeichnungen

### Miscellaneous

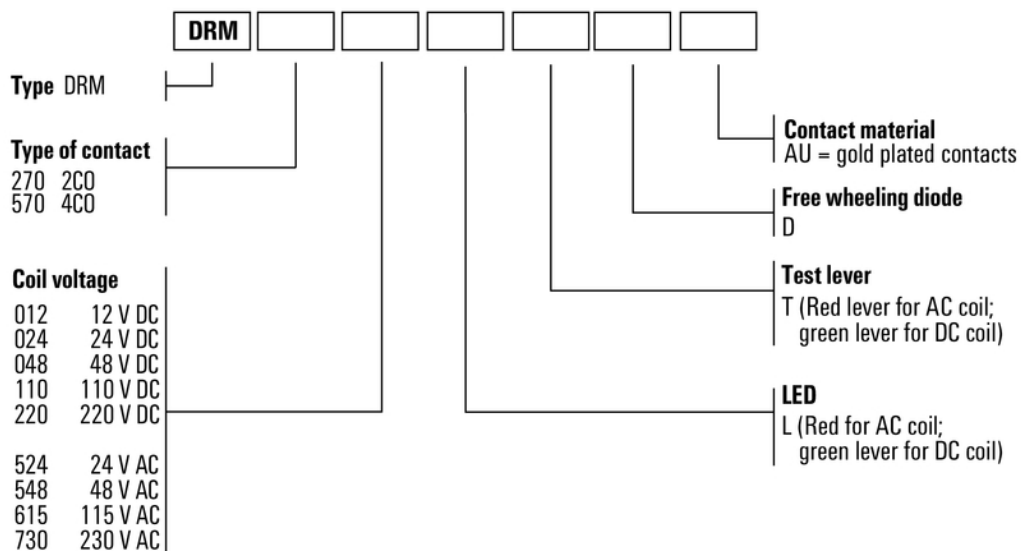

Type codes