

## SAIL-M12GM8G-3-6.4U

**Weidmüller Interface GmbH & Co. KG**  
 Klingenbergstraße 26  
 D-32758 Detmold  
 Germany

www.weidmueller.com



Sensor/actuator cables are used for wiring sensors and actuators and for transmitting data or power in various applications. The moulded cable offers connected and tested connection of the plug-in connector to the cable ex-works. The cables may be exposed to a wide range of conditions, such as humidity, dust, heat, cold, shock or vibration.

Our developers have focused specifically on this issue and designed a host of different M8 and M12 sensor-actuator cables so you are bound to find the solution you need for your application.

Is there something you have not managed to find or you feel needs explanation? Talk to us!

### General ordering data

Version	Sensor/actuator line, Connecting line, M12 / M8, Number of poles : 3, 6.4 m, pin, straight - socket, straight, Shielded: No, LED: No, Sheath material: PUR, Halogen: No
Order No.	<a href="#">9457770640</a>
Type	SAIL-M12GM8G-3-6.4U
GTIN (EAN)	4050118627091
Qty.	1 Stück

Erstellungs-Datum May 24, 2023 4:54:18 PM CEST

Katalogstand 12.05.2023 / Technische Änderungen vorbehalten

## SAIL-M12GM8G-3-6.4U

**Weidmüller Interface GmbH & Co. KG**

Klingenbergstraße 26

D-32758 Detmold

Germany

www.weidmueller.com

## Technische Daten

### Dimensions and weights

Net weight 250 g

### Technical specifications for cable

Acceleration	5 m/s <sup>2</sup>	Bending cycles	12 Mio
Bending cycles at torsion	> 5 Mio.	Bending radius, min., moving	10 x cable diameter
Bending radius, min., stationary	5 x cable diameter	Cable length	6.4 m
Colour coding	brown, blue, black	Configurable cable length	No
Core cross-section	0.25 mm <sup>2</sup>	Core in accordance with UL AWM style	10493 (80 °C / 300 V)
Halogen	No	Hydrolysis and microbe resistant	Yes
Insulation	PP	Irradiation crosslinked	No
Length of torsion	1 m	Number of poles	3
Outer cladding in accordance with UL AWM style	20549 (80 °C / 300 V)	Outside diameter	4.1 mm ± 0.2 mm
Resistance to oils	in accordance with IEC 60811:404	Resistance to spread of flame	in accordance with IEC 60332-2-2, In accordance with UL1581 UL / CUL FT2
Resistant to welding beads	No	Sheath material	PUR
Sheathing colour	black	Shielded	No
Speed	5 m/s	Suitable for cable carriers	Yes
Temperature range, moving	-25...80 °C	Temperature range, stationary	-40...80 °C
Torsion resistance	360 °/m	Welding spark resistance	No

### General technical data

Connection thread	M12 / M8	Contact surface	Gold-plated
Housing main material	PUR	Insulation strength	10 <sup>8</sup> Ω
LED	No	Plugging cycles	≥ 100
Pollution severity	3	Protection degree	IP69, IP65, IP66
Rated current	4 A	Rated voltage	60 V
Temperature range of housing	-40 ... +85 °C	Threaded ring material	Brass, nickel-plated, Diecast zinc
Version	pin, straight - socket, straight		

### Electrical properties

Insulation strength 10<sup>8</sup> Ω      Rated voltage 60 V

## SAIL-M12GM8G-3-6.4U

**Weidmüller Interface GmbH & Co. KG**  
 Klingenbergstraße 26  
 D-32758 Detmold  
 Germany

www.weidmueller.com

## Technische Daten

### Plug

Plug	Cable side	left
	Version of contact face	M12
	Coding of plug	A
	Protection degree (IP)	IP69
	Gender of contact	male contact
	Outlet direction	straight
	Housing main material	Plastic
	Shielding available	No
	Cable side	right
	Version of contact face	M8
	Protection degree (IP)	IP69
	Gender of contact	female contact
	Outlet direction	straight
	Housing main material	Plastic
	Status indicator available	Yes
	Status indicator	LED
	Shielding available	No
	Plug left	M12, A, IP69, male contact, straight, Plastic, unshielded
Plug right	M8, IP69, female contact, straight, Plastic, LED, unshielded	

### Classifications

ETIM 6.0	EC001855	ETIM 7.0	EC001855
ETIM 8.0	EC001855	ECLASS 9.0	27-06-03-11
ECLASS 9.1	27-06-03-11	ECLASS 10.0	27-06-03-11
ECLASS 11.0	27-06-03-11	ECLASS 12.0	27-06-03-11

### Environmental Product Compliance

REACH SVHC	Lead 7439-92-1
SCIP	1c533b66-fcff-4da5-b89f-fd55fbf5cb55

### Approvals

Approvals	
ROHS	Conform

### Downloads

Engineering Data	<a href="#">CAD data – STEP</a>
Catalogues	<a href="#">Catalogues in PDF-format</a>

**SAIL-M12GM8G-3-6.4U**

**Weidmüller Interface GmbH & Co. KG**  
 Klingenbergstraße 26  
 D-32758 Detmold  
 Germany

www.weidmueller.com

**Zeichnungen**

**Dimensioned drawing**

**Dimensioned drawing**

Male, straight

Straight socket

**Pole scheme**

**Pole scheme**

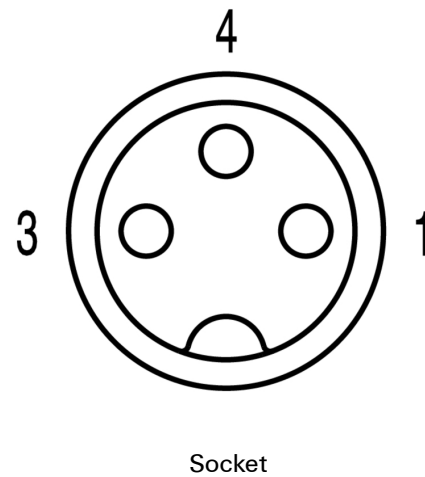
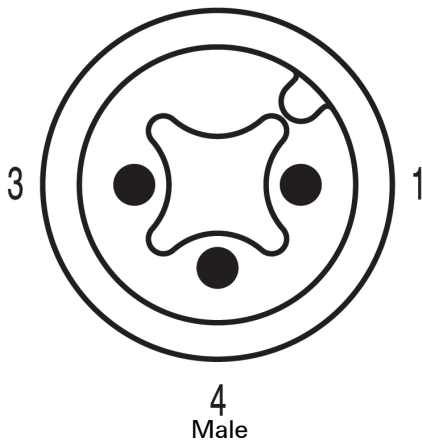

**Wiring diagram**

**The ideal tool: Screwty® with torque function**

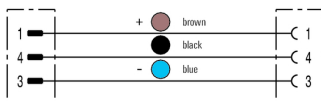

Light, securely screwed-in round plug-in connectors. Screwty set DM / VPE: 1 / Order No.: 1920000000 Adapters: M12, M12 F, M8, M8 F