

# STANDARD HOLE PROCESSING EXAMPLES ④

Unless indicated otherwise, the end face of the hole plates is C0.5. The applications illustrated here are just processing examples. In actual application, it is necessary to consider a wide array of conditions and requirements, including pitch precision between holes, perpendicularity of the holes, surface roughness, roundness, plate material, parallelism, whether or not quenching is required, molding machine precision, product production volume, and tool wear. For this reason, please understand that MISUMI cannot accept any responsibility for problems that may arise from use of these examples.

## Precision Leader Pin

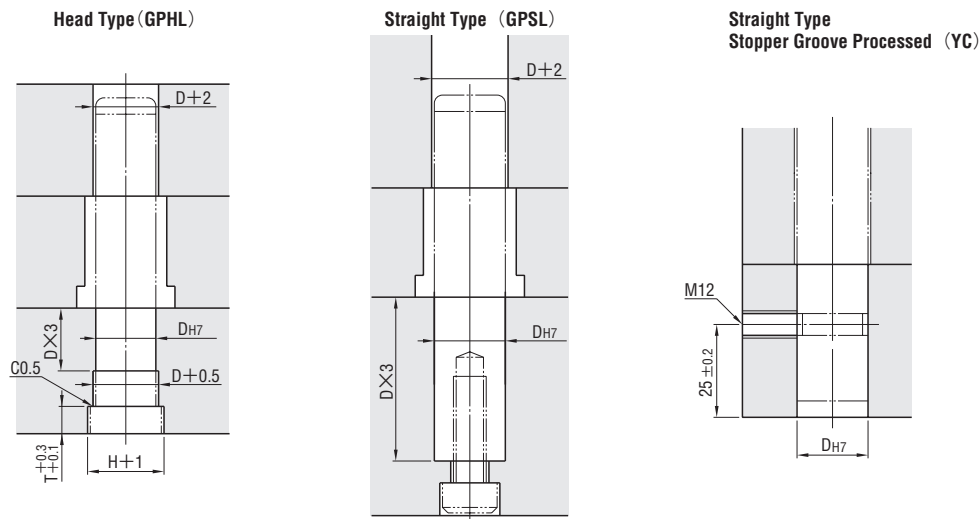

## Precision Leader Bushing

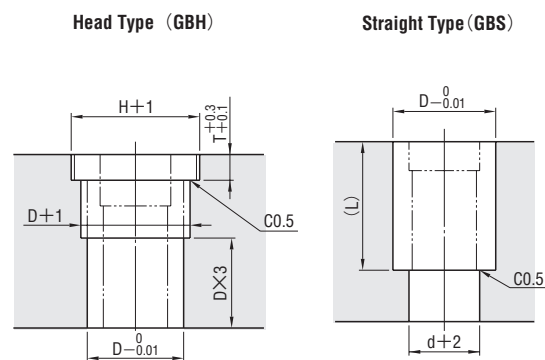

## Support Pin - Support Pin Collar

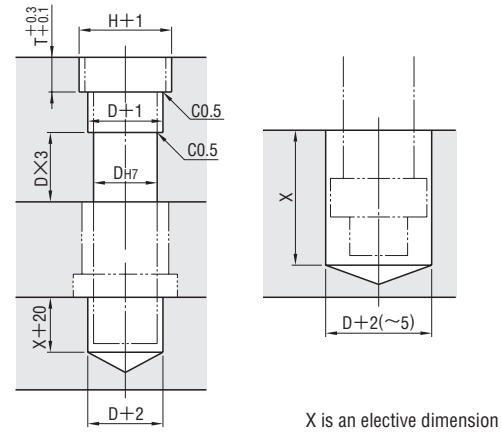

## Precision Ejector Leader Pin

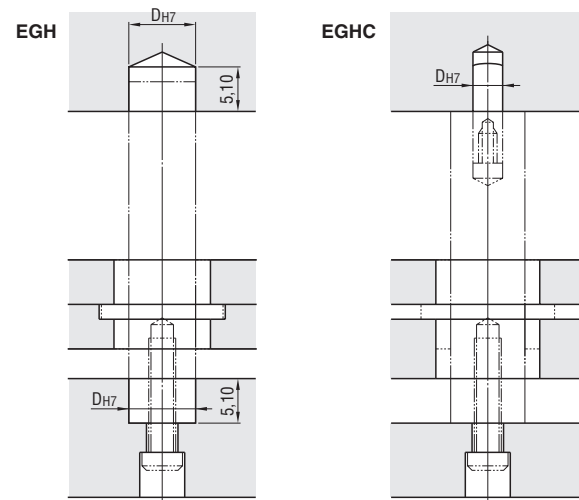

## Ejector Leader Pin

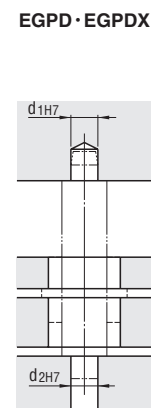

## Ejector Leader Bushing

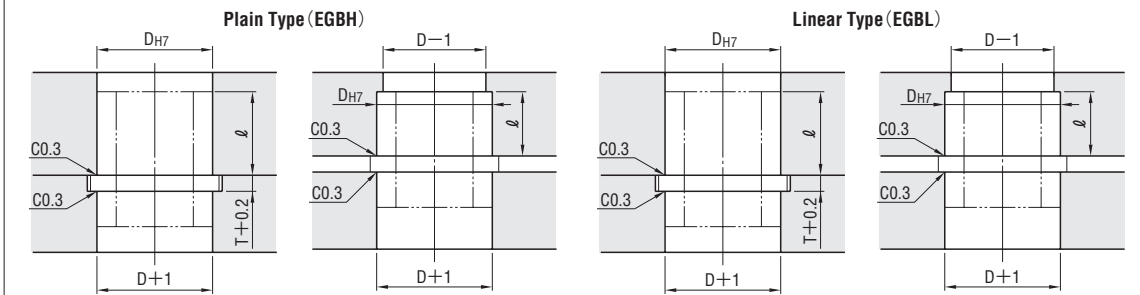

## EGBZ

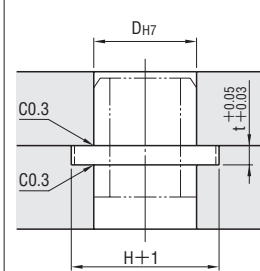

## Return Pin

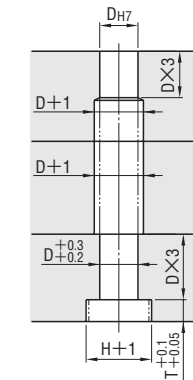

## Support Pillar

(SPL)

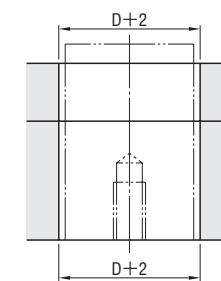

## Stop Pin

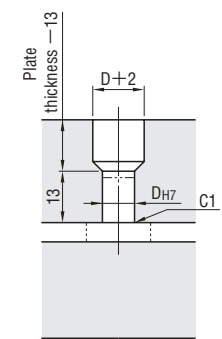

## Tension Link Retainer

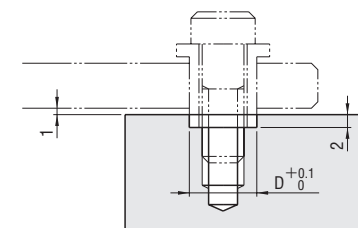

## Stopper Bolt · Puller Bolt

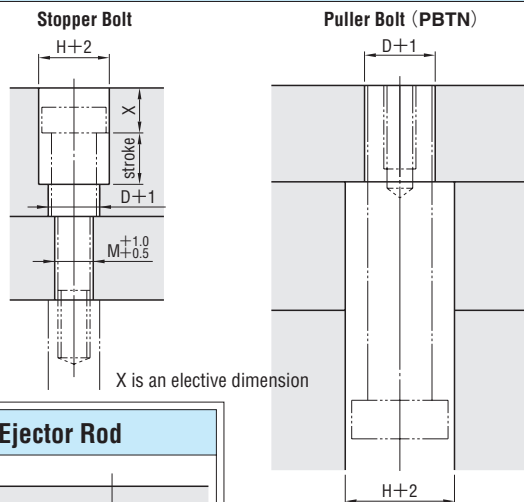

## Joint Plug

(JTW · JTWS)

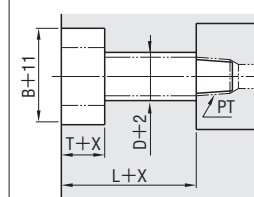

## Cooling Pipe

(WCP · WCSP)

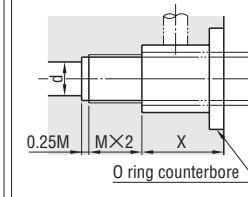

## Ejector Rod

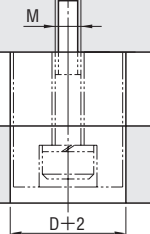

## Puller Bolt Collar

