

# BA 281709-7035

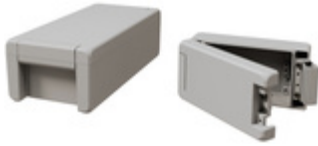

Bocube Alu  
Enclosure with smooth lid, light grey, hinged

Order no.: 00116335

**Colour of enclosure group**

Graphite grey, similar to RAL 7024; light grey, similar to RAL 7035; special colours on request

**Protection class**

IP 66 / IP 67 / IP 69 DIN EN 60529

**Enclosure material**

Enclosure: GD Al Si 12, seal PU foamed; Hinges / covers: Al Mg Si 0.5 powder-coated / natural-coloured anodised

Scope of delivery: enclosure incl. hinge and fixing material

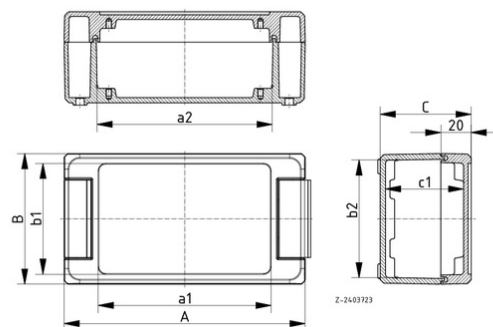

<b>A</b>	299 mm
<b>B</b>	173 mm
<b>C</b>	90 mm
<b>a1</b>	- mm
<b>a2</b>	254,5 mm
<b>b1</b>	- mm
<b>b2</b>	163,5 mm
<b>c1</b>	83,5 mm

**Technical drawings**

Catalogue drawing in DXF format:

[00116335\\_BA-281709-7035.dxf](#) (3.0 MB)

Catalogue drawing in PDF format:

[00116335\\_BA-281709-7035.pdf](#) (239 KB)

3D product data in STEP format:

[Registration necessary](#)

Basic drawing for processing work:

[00116335\\_BA-281709-7035-G.dxf](#) (2.1 MB)

**Assembly instructions**

[Bocube Alu\\_00911501.pdf](#) (127 KB)

**Chapter download**

[Bocube Alu\\_GB.pdf](#) (1.7 MB)

\* = Available on request