

SEDECO BN-0751 230V NEON INDICATOR LIGHT

Unit: mm

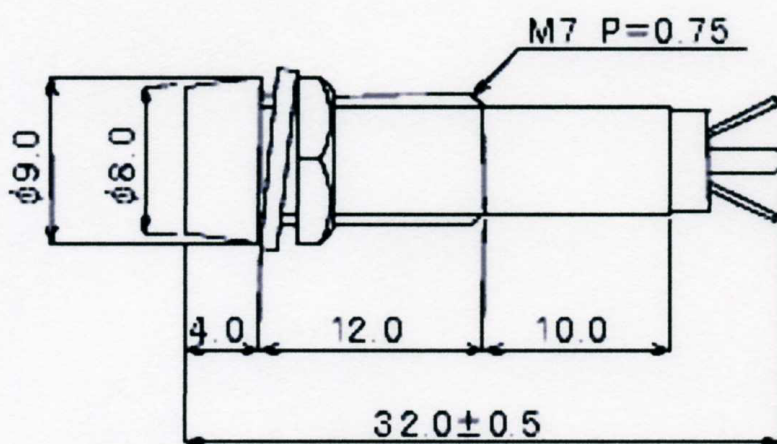

DATA	
Material of Body	Chrome Plated Brass +Polycarbonate Lens
Color	Red, Transparent
Voltage	230V AC
Resistor (Built-in)	1/2W 120K Ω (for 220V ~ 240V)
Operating Temperature	-20 $^{\circ}$ C ~ +75 $^{\circ}$ C
Shape of Terminal	Solder Terminal
Thread	Φ 7.0mm X L 12.0mm Pitch = 0.75mm
Mounting Hole (Recommended)	Φ 7.2mm