

# APEM

## IA series

### Low profile pushbutton switches

- Resistant to frost, sand and hydrocarbons
- Front panel sealed to IP 67
- Tactile feedback

#### ELECTRICAL AND GENERAL SPECIFICATIONS

- Max. current/voltage rating with resistive load : 2A 24VDC
- Initial contact resistance : 100mΩ max.
- Insulation resistance : 100 MΩ min. at 500VDC
- Dielectric strength : 1.000 VAC rms
- Electrical life at full load : 1 000.000 cycles
- Panel thickness : 7 mm (.276) max.
- Total travel : 1,5 mm +/- 0,3 (.059 +/- .012)
- Operating force : 6,5 N ±2N

#### ENVIRONMENTAL SPECIFICATIONS

- Front panel sealing (see drawings below) :
  - With O-ring above the panel : IP67
  - With O-ring under the panel : IP64
- Operating temperature : -20°C to +65°C

#### MATERIALS

- Case/bushing : thermoplastic
- Actuator : polyurethane
- Contacts : silver
- Terminal seal : epoxy

#### PANEL MOUNTING

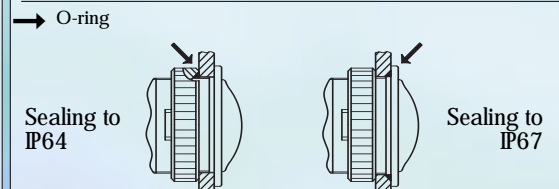

IA						
SERIES	Electrical function	Contacts	Plunger col.	Case colour	Shape	Terminals
	3 Normally open (NO) 5 NC/NO combined	1 Silver	1 Blue 2 Black 3 Green 5 Yellow 6 Red 7/1 White 9 Orange	00 Black	R Round	F Wire leads

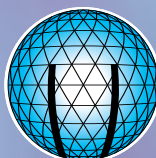

APEM



# IA series - Low profile pushbutton switches

## Bushing Ø 16 (.629)

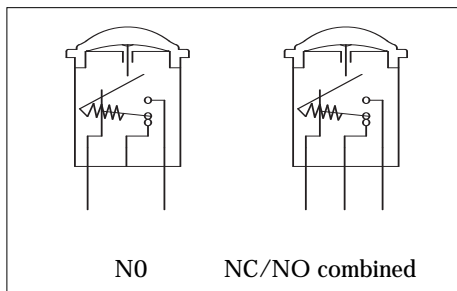

- Panel cut-out Ø 16,2 mm (.657)
- Min. pitch for matrix mounting : 20 x 20 mm (.787x.787)
- Standard hardware supplied : 1 knurled nut and 1 O-ring
- Packaging unit : 25 pieces

### MODEL STRUCTURE

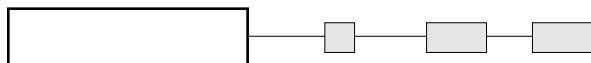

NO model has 2 terminals only.

### Models



Normally open  
IAR3F



NC/NO combined  
IAR5F

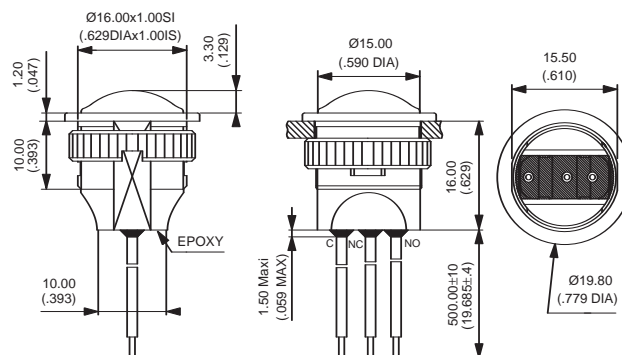

Wire colours (NC/NO) : black = common, brown = NC, blue = NO

### CONTACT MATERIAL

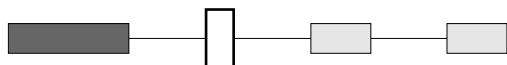

1 Silver

### PLUNGER COLOUR

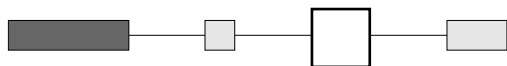

1 : blue - 2 : black - 3 : green - 5 : yellow - 6 : red - 7/1 : white - 9 : orange

### CASE COLOUR

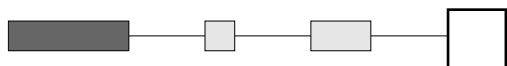

00 : black

Dimensions : First dimensions are in mm while inches are shown as bracketed numbers.

Tolerance : The general tolerance for dimensions is +/- 0,3 (.012).

Dimensions, specifications and data are subject to change without notice.