



Bajonett Steckverbinder

Bayonet connectors

Kabelsteckverbinder

- Steckverbinder mit Bajonettverriegelung
- Schutzart IP40 ¹⁾
- Integrierte Kabelzugentlastung
- Transparenter Kabelknickschutz

Cable Connector

- Connector with bayonet locking
- Degree of protection IP40 ¹⁾
- Internal strain relief
- Transparent cable bushing



Aufbau des Steckverbinders:
Construction of the connector:

Kabelstecker und
 Flanschdose
*Male cable connector and
 female socket connector*

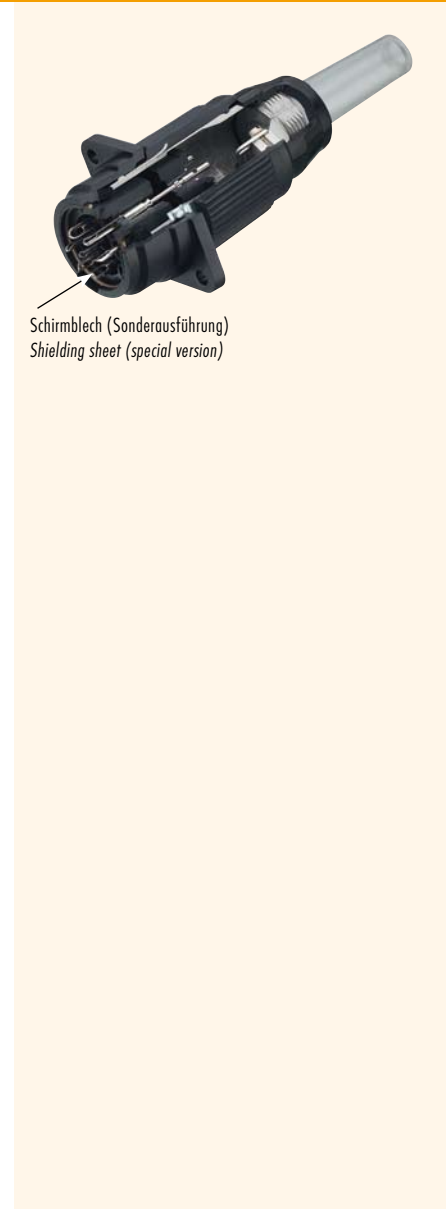

Schirmblech (Sonderausführung)
Shielding sheet (special version)

- ü
- Ti
- SI IP40
- SI IP67
- Bajonett
- MPP IP67
- PP IP67
- M9 IP40
- M9 IP67
- SI IP67
- Bajonett
- PP IP67
- M16 IP40
- M16 IP67
- M23
- Bajonett
- M25
- RD24
- RD30
- M5
- M8
- M12-A
- VL
- Verteiler
- M12-B
- M12-D
- M12-US
- M18
- 7/8"
- BF-A
- BF-B
- BF-C
- R

Leistungs Steckverbinder Serie 690 Power connectors series 690

Bezeichnung
Description

Kabelstecker
Male cable connector

Kabeldose
Female cable connector

Abbildung
Figure



Maßzeichnung
Drawing

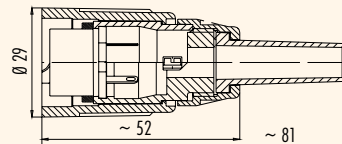
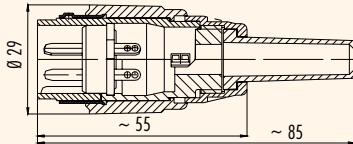

Bestell-Nr.
Ordering-No.

Polzahl Contacts	Bestell-Nr. Ordering-No.
3	09-0055-00-03
5	09-0059-00-05
7	09-0063-00-07
12	09-0467-00-12

Polzahl Contacts	Bestell-Nr. Ordering-No.
3	09-0056-00-03
5	09-0060-00-05
7	09-0064-00-07
12	09-0468-00-12

Technische Daten
Specifications

	3	5	7	12	
Polzahl	3	5	7	12	Number of contacts
Steckverbinder Verriegelung	bajonett/bayonet				Connector locking system
Anschlussart	löten/solder				Termination
Anschlussquerschnitt	max. 2,5 mm ² (max. AWG 16)		max. 0,75 mm ² (max. AWG 20)		Wire gauge
Kabeldurchlass	5-8 mm				Cable outlet
Schutzart	IP40				Degree of protection
Mechanische Lebensdauer	> 500 Steckzyklen/> 500 mating cycles				Mechanical operation
Obere Grenztemperatur	+ 85 °C				Upper temperature
Untere Grenztemperatur	- 40 °C				Lower temperature
Bemessungsspannung	250 V		125 V		Rated voltage
Bemessungs-Stoßspannung	2500 V		1500 V		Rated impulse voltage
Verschmutzungsgrad	I				Pollution degree
Überspannungskategorie	II				Overvoltage categorie
Isolierstoffgruppe	III				Material group
Bemessungsstrom (40 °C)	10 A		5 A		Rated current (40 °C)
Durchgangswiderstand	≤ 5 mΩ		≤ 8 mΩ		Contact resistance
Material Kontakt	Stift/pin CuZn (Messing/brass), Buchse/socket CuSn (Bronze/bronze)				Material of contact
Kontaktoberfläche	Ag (Silber/silver) Stift 7+12 pol. CuZnSn (male contact 7+12 contacts CuZnSn)				Contact plating
Material Kontaktkörper	PET (UL 94 V-0)				Material of contact body
Material Gehäuse	GD-Al (eloxiert/anodized)				Material of housing

Leistungs Steckverbinder Serie 690 Power connectors series 690

Bezeichnung
Description

Abbildung
Figure

Flanschstecker
Male socket



Flanschdose
Female socket



Flanschdose mit Schirmblech
Female socket with shielding sheet



Maßzeichnung
Drawing

Ansicht ohne Polbild
View without contacts

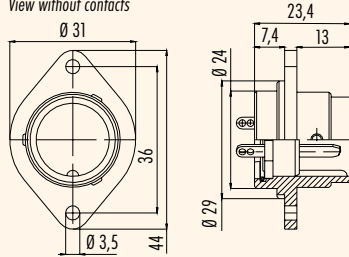

Ansicht ohne Polbild
View without contacts

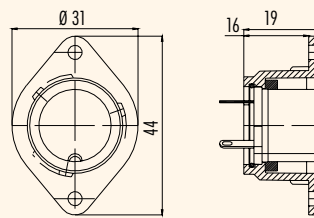

Ansicht ohne Polbild
View without contacts

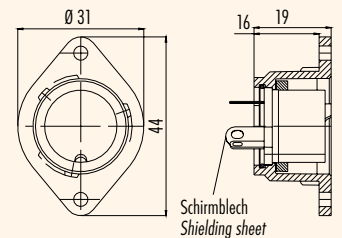

Bestell-Nr.
Ordering-No.

Polzahl Contacts	Bestell-Nr. Ordering-No.	Polzahl Contacts	Bestell-Nr. Ordering-No.	Polzahl Contacts	Bestell-Nr. Ordering-No.
3	09-0057-00-03	3	09-0058-00-03	3	09-0058-70-03
5	09-0061-00-05	5	09-0062-00-05	5	09-0062-70-05
7	09-0065-00-07	7	09-0066-00-07	7	09-0066-70-07
12	09-0469-00-12	12	09-0470-00-12	12	-

Technische Daten
Specifications

Polzahl	3	5	7	12	
Steckverbinder Verriegelung	bajonett/bayonet				Number of contacts
Anschlussart	löten/solder				Connector locking system
Anschlussquerschnitt	max. 2,5 mm ² (max. AWG 16)		max. 0,75 mm ² (max. AWG 20)		Termination
Kabeldurchlass	-				Wire gauge
Schutzart	IP40				Cable outlet
Mechanische Lebensdauer	> 500 Steckzyklen / > 500 mating cycles				Degree of protection
Obere Grenztemperatur	+ 85 °C				Mechanical operation
Untere Grenztemperatur	- 40 °C				Upper temperature
Bemessungsspannung	250 V		125 V		Lower temperature
Bemessungs-Stoßspannung	2500 V		1500 V		Rated voltage
Verschmutzungsgrad	1				Rated impulse voltage
Überspannungskategorie	II				Pollution degree
Isolierstoffgruppe	III				Overvoltage categorie
Bemessungsstrom (40 °C)	10 A		5 A		Material group
Durchgangswiderstand	≤ 5 mΩ		≤ 8 mΩ		Rated current (40 °C)
Material Kontakt	Stift/pin CuZn (Messing/brass), Buchse/socket CuSn (Bronze/bronze)				Contact resistance
Kontaktoberfläche	Ag (Silber/silver) Stift 7+12 pol. CuZnSn (male contact 7+12 contacts CuZnSn)				Material of contact
Material Kontaktkörper	PET (UL 94 V-0)				Contact plating
Material Gehäuse	GD-Al (eloxiert/anodized)				Material of contact body
					Material of housing

Leistungs Steckverbinder Serie 690 Power connectors series 690

Polbilder
Contact arrangements

Stifteinsatz (Steckseite)
Male insert (mating side)

Buchseinsatz (Steckseite)
Female insert (mating side)

3 pol
3 contacts

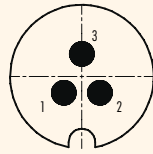

	X	Y
1	-2,39	-2,14
2	2,39	-2,14
3	0,00	3,00

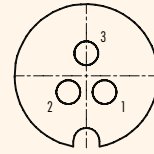

	X	Y
1	2,39	-2,14
2	-2,39	-2,14
3	0,00	3,00

5 pol
5 contacts

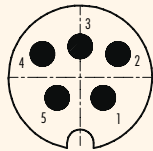

	X	Y
1	3,05	-2,70
2	5,00	3,10
3	0,00	4,10
4	-5,00	3,10
5	-3,05	-2,70

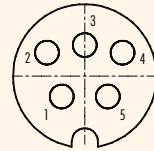

	X	Y
1	-3,05	-2,70
2	-5,00	3,10
3	0,00	4,10
4	5,00	3,10
5	3,05	-2,70

7 pol
7 contacts

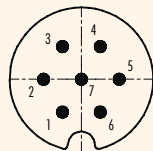

	X	Y
1	-2,50	-4,33
2	-5,00	0,00
3	-2,50	4,33
4	2,50	4,33
5	5,00	0,00
6	2,50	-4,33
7	0,00	0,00

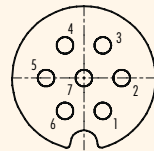

	X	Y
1	2,50	-4,33
2	5,00	0,00
3	2,50	4,33
4	-2,50	4,33
5	-5,00	0,00
6	-2,50	-4,33
7	0,00	0,00

12 pol
12 contacts

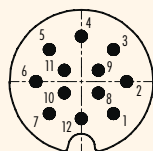

	X	Y
1	4,24	-4,24
2	6,00	0,00
3	4,24	4,24
4	0,00	6,00
5	-4,24	4,24
6	-6,00	0,00
7	-4,24	-4,24
8	2,25	-1,50
9	2,25	1,50
10	-2,25	-1,50
11	-2,25	1,50
12	0,00	-4,90

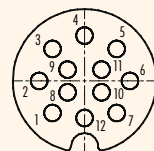

	X	Y
1	-4,24	-4,24
2	-6,00	0,00
3	-4,24	4,24
4	0,00	6,00
5	4,24	4,24
6	6,00	0,00
7	4,24	-4,24
8	-2,25	-1,50
9	-2,25	1,50
10	2,25	-1,50
11	2,25	1,50
12	0,00	-4,90

Montageausschnitt
Panel cut out

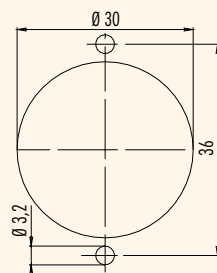

Leistungs Steckverbinder Serie 690
Power connectors series 690

Einzelteildarstellung
Component part drawing

Kabelstecker
Male cable connector

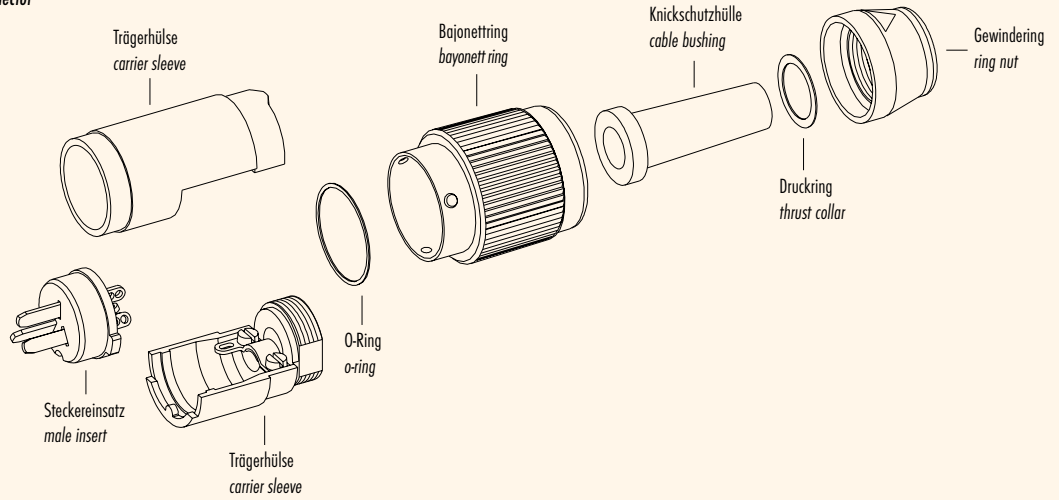

Kabeldose
Female cable connector

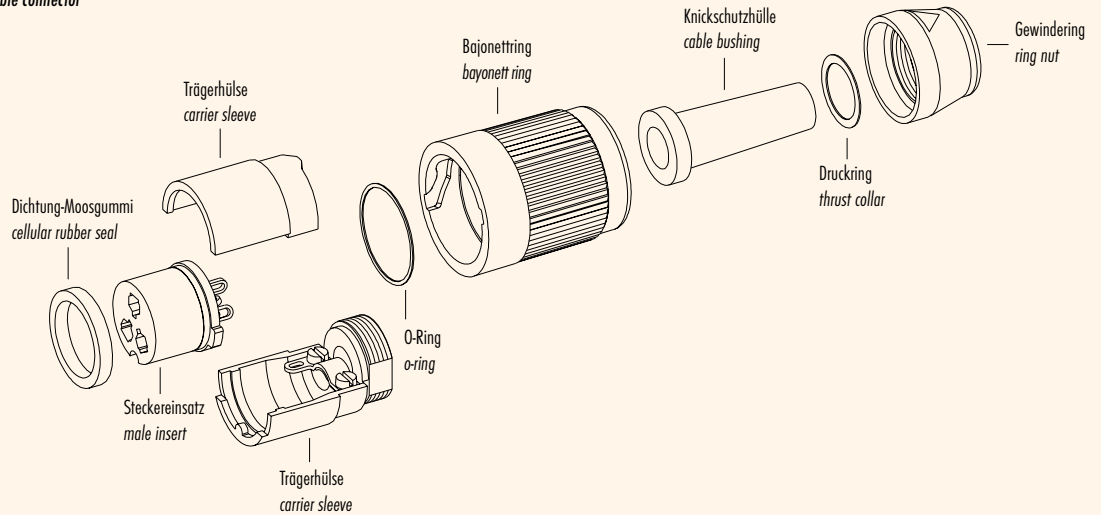

Flanschsteckverbinder
Socket connectors

