

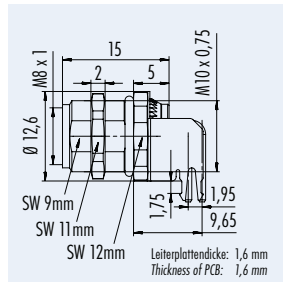

## M8 Flanschdosen – Erweiterung Baukastensystem

### M8 Female Panel Mount Connectors – Enlargement of our Modular System

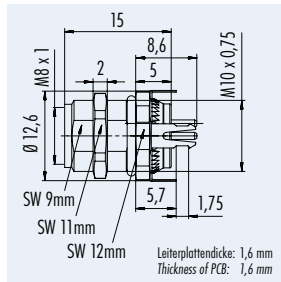
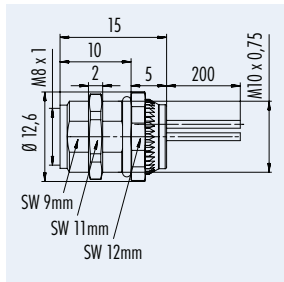
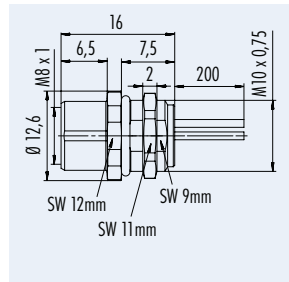
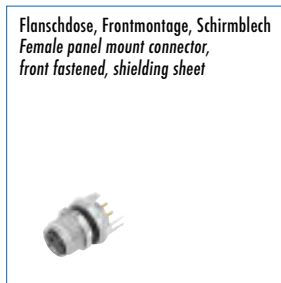

Polzahl Contacts	Bestell-Nr. Ordering-Nr.
3	09 3418 00 03
4	09 3420 00 04
5	09 3424 00 05
6	09 3422 00 06
8	09 3426 00 08

Polzahl Contacts	Bestell-Nr. Ordering-Nr.
3	09 3418 86 03
4	09 3420 86 04
5	09 3424 86 05
6	09 3422 86 06
8	09 3426 86 08

Polzahl Contacts	Bestell-Nr. Ordering-Nr.
3	09 3418 81 03
4	09 3420 81 04
5	09 3424 81 05
6	09 3422 81 06
8	09 3426 81 08

Polzahl Contacts	Bestell-Nr. Ordering-Nr.
3	09 3418 82 03
4	09 3420 82 04
5	09 3424 82 05
6	09 3422 82 06

Bezeichnung Flanschdose, Frontmontage, mit Litzen  
Bereich M 8 Sensorsteckverbinder

Serie 768/718

Polzahl 4  
Bestellnummer 09 3420 86 04

Abbildung



Maßzeichnung

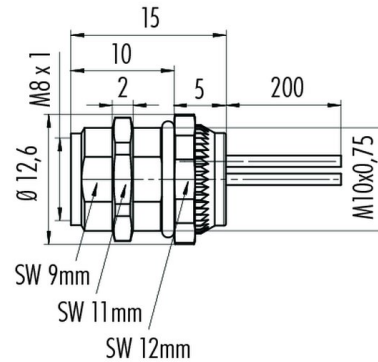

Polbild

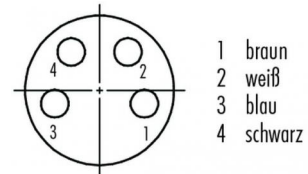

Technische Daten

Allgemeine Kennwerte

Steckverbinder-Bauform	Flanschdose
Steckverbinder Verriegelung	Schraub
Anschlussart	Litzen 0,25
Anschlußquerschnitt (mm)	0,25 mm <sup>2</sup>
Anschlußquerschnitt (AWG)	24
Obere Grenztemperatur	+85 °C
Untere Grenztemperatur	-40 °C

Werkstoffe

Material Kontakt	CuSn (Bronze)
Kontaktoberfläche	Au (Gold)
Material Kontaktkörper	PA (UL 94 HB)
Material Gehäuse	Zink Druckguss vernickelt

Elektrische Kennwerte

Bemessungsspannung	30 V
Bemessungs-Stoßspannung	800 V
Verschmutzungsgrad	3
Überspannungskategorie	II
Isolierstoffgruppe	II
Bemessungsstrom (40 °C)	4 A
Durchgangswiderstand	≤ 3 mΩ
Schutzart	IP 67
Mechanische Lebensdauer	>100 Steckzyklen

Kabeldaten

Polzahl: 4, Flanschdose, Frontmontage, mit Litzen

