

Type No:ADP16
Order No:ADP16B4-0R0-0140

RoHS
Compliant

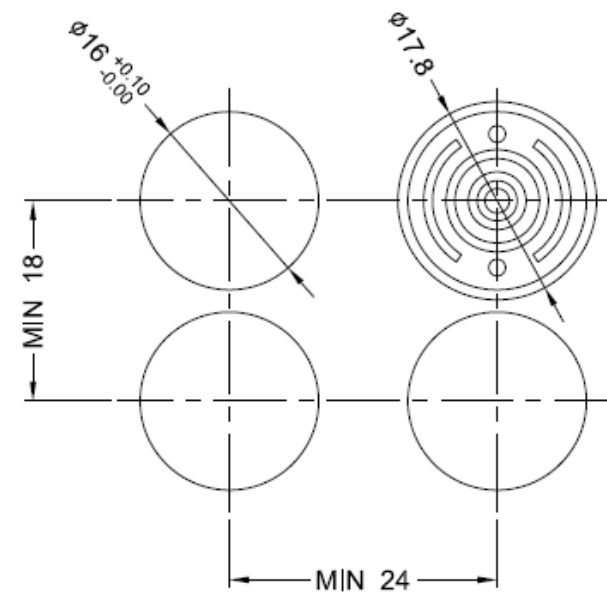

PCB Layout

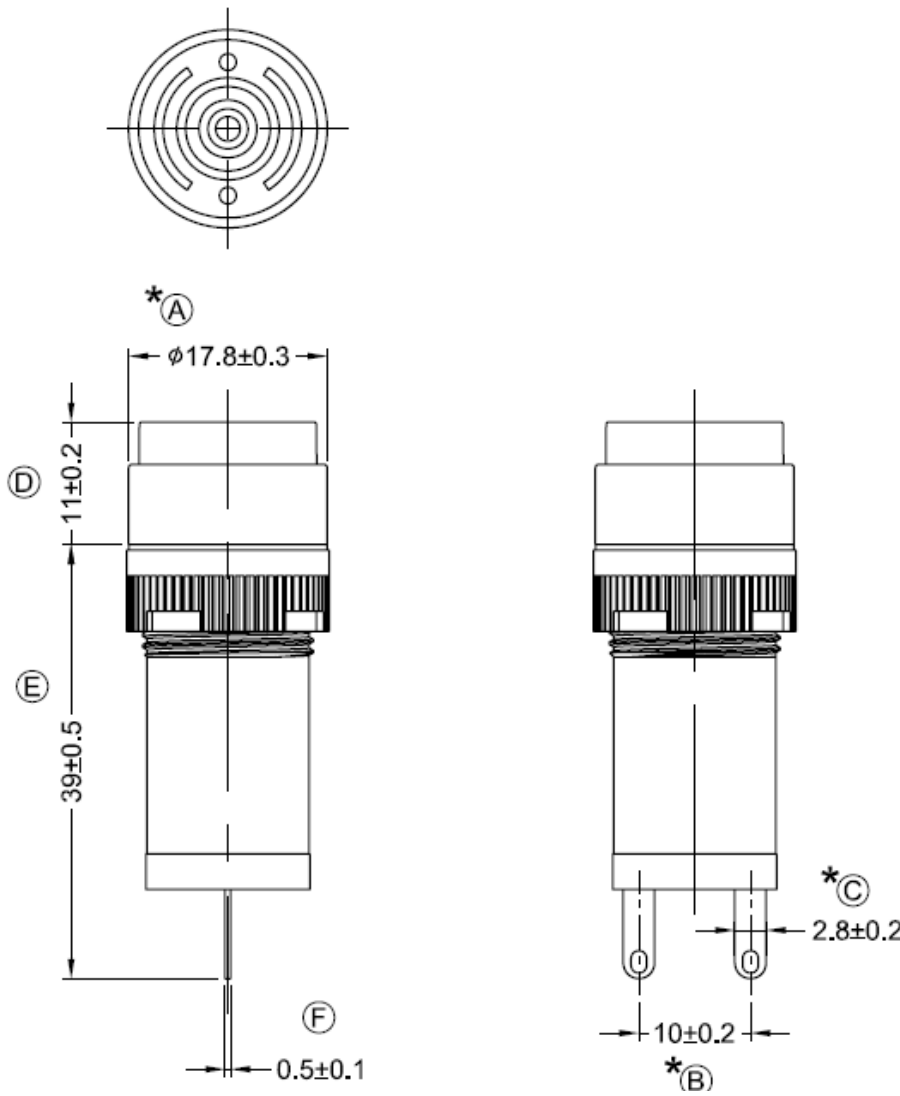























Current rating : 25mA DC12~24V
Operation temperature : -25°C to +55°C
Electrical lifetime : 1000hr
Sound pressure : 80db
Terminal : soldering type / plug-in type
Wire range : 1x1.5mm² max.
Cable range : 2x0.75mm² / 1x1.0mm² max.
Voice : Continuous tone



CONFIRMED & ACCEPTED BY: _____

DECA[®]SwitchLab Inc.			PART NAME	UNIT	SCALE
			Terminal Blocks	MM	1:1
DESIGN	CHECK	APPROVE	DRAWING NO.	SHEET	
DATE 2014/07/25	DATE 2014/07/25	DATE 2014/07/25	ADP16B4-0R0-0140		

Distributed by Conrad Electronic SE

D
REV.

Keylock Switches							
Series	Head Shape	Illustration	Two Position		Color	Page No.	
ADP16K Series (IP40 plug-in)	Standard		Alternate	A 	ADP16K4-AR0-1A	■	39-41
				C 	ADP16K4-AR0-1C		
				E 	ADP16K4-AR0-1E		
				F 	ADP16K4-AR0-1F		
				Momentary	U 		
	Square		Alternate	A 	ADP16K4-AS0-1A	■	39-41
				C 	ADP16K4-AS0-1C		
				E 	ADP16K4-AS0-1E		
				F 	ADP16K4-AS0-1F		
				Momentary	U 		
	Rectangular		Alternate	A 	ADP16K4-AT0-1A	■	39-41
				C 	ADP16K4-AT0-1C		
				E 	ADP16K4-AT0-1E		
				F 	ADP16K4-AT0-1F		
				Momentary	U 		
	Flange		Alternate	A 	ADP16K4-AA0-1A	■	39-41
				C 	ADP16K4-AA0-1C		
				E 	ADP16K4-AA0-1E		
				F 	ADP16K4-AA0-1F		
				Momentary	U 		

Buzzer					
Series	Head Shape			Color	Page No.
	Round	Square	Rectangular		
ADP16B Series (IP40)				■	44-46
	ADP16B4-0R0-0140	ADP16B4-0S0-0140	ADP16B4-0T0-0140		

DESCRIPTION

- * Multiple designs to fit with different panel with options for continuous or intermittent tone.
- * Available Size : Rectangular 18x24 mm
Square 18x18 mm
Round diameter : ~18mm
- * IP 40 protection degree enable the device to be used in equipments of various fields.
- * The sound pressure 80 db at a distance of 0.1m.
- * Approvals: UL/CUL/VDE/CE pending

**SPECIFICATIONS**

Rated Voltage	DC12~24V	Terminal	Soldering type
Rated Current	min100mA~max3A	Wire Range	1x1.5mm ² max
Electrical Life	1000hr(continuous tone)	Cable Range	2x0.75mm ² /1x1.0mm ² Max
Sound Pressure	80dB(continuous tone)	Storage Temperature	-40°C~+70°C
Sound Frequency	2±0.5KHzr	Operating Temperature	-25°C~+55°C
Flickering Cycle	55cycles±10%(Intermittent tone)	Degree of Protection	IP40

ORDER INFORMATION

MODEL FORMAT ADP16B4-0**1**0-0**2**40

1 HEAD SHAPE

- R : ROUND
- S : SQUARE
- T : RECTANGULAR

2 VOICE

- 1 : CONTINUOUS TONE
- 2 : INTERMITTENT TONE

CURRENT RATING

DC 12-24V



unit: mm

SHAPE			
DIMENSIONS	Ø 18	18x18	18x24

HEAD SHAPE

ADP16B4-0R0-0140

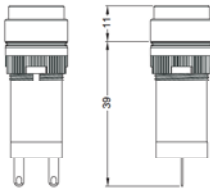

ADP16B4-0S0-0140

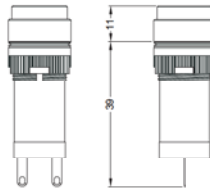

ADP16B4-0T0-0140

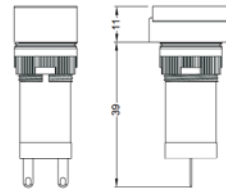

MOUNTING DIMENSIONS

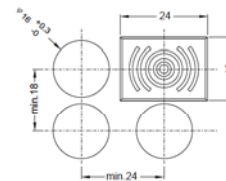
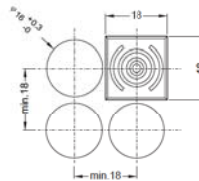
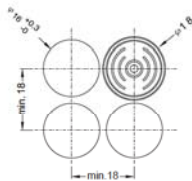

Panel Thickness 0.5 To 5.0