

Type No:ADP16  
 Order No:ADP16B4-0S0-0140

RoHS  
 Compliant

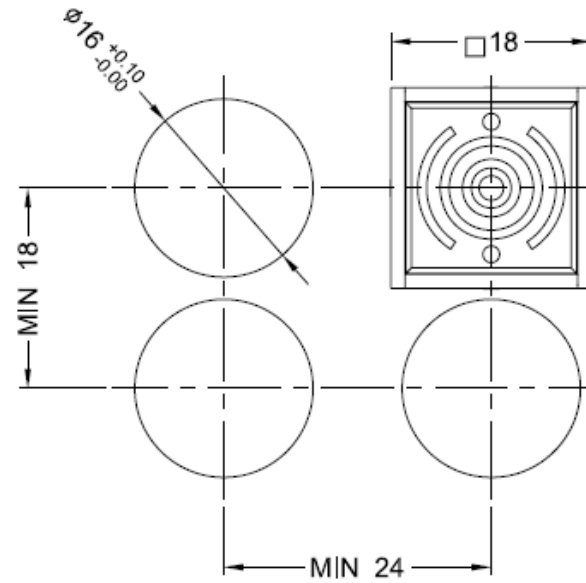

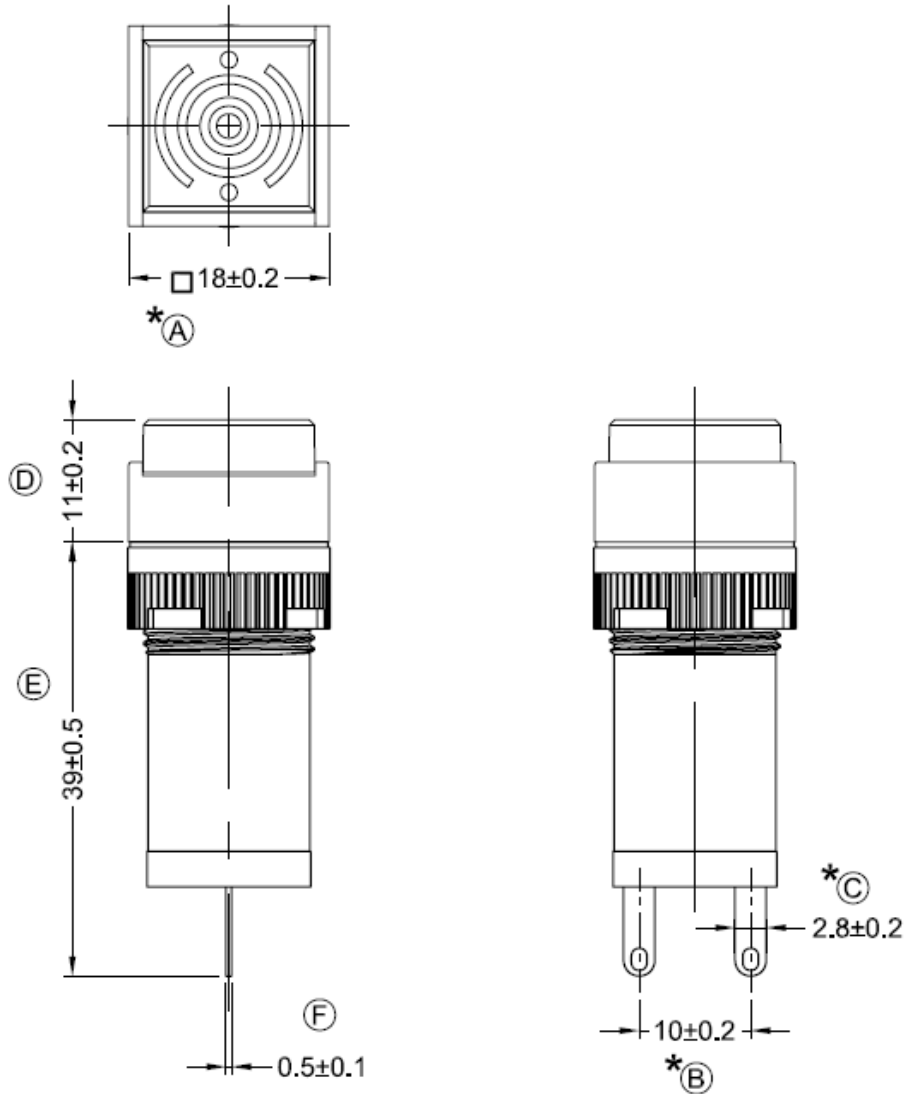























PCB Layout



Current rating : 25mA DC12~24V  
 Operation temperature : -25°C to +55°C  
 Electrical lifetime : 1000hr  
 Sound pressure : 80db  
 Terminal : soldering type / plug-in type  
 Wire range : 1x1.5mm<sup>2</sup> max.  
 Cable range : 2x0.75mm<sup>2</sup> / 1x1.0mm<sup>2</sup> max.  
 Voice : Continuous tone

CONFIRMED & ACCEPTED BY:

<b>DECA<sup>®</sup>SwitchLab Inc.</b>			PART NAME	UNIT	SCALE
			Terminal Blocks	MM	1:1
DESIGN	CHECK	APPROVE	DRAWING NO.	 SHEET	
DATE 2014/07/25	DATE 2014/07/25	DATE 2014/07/25	ADP16B4-0S0-0140		1/1

Distributed by Conrad Electronic SE

Keylock Switches							
Series	Head Shape	Illustration	Two Position		Color	Page No.	
ADP16K Series (IP40 plug-in)	Standard		Alternate	A 	ADP16K4-AR0-1A	■	39-41
				C 	ADP16K4-AR0-1C		
				E 	ADP16K4-AR0-1E		
				F 	ADP16K4-AR0-1F		
				Momentary	U 		
	Square		Alternate	A 	ADP16K4-AS0-1A	■	39-41
				C 	ADP16K4-AS0-1C		
				E 	ADP16K4-AS0-1E		
				F 	ADP16K4-AS0-1F		
				Momentary	U 		
	Rectangular		Alternate	A 	ADP16K4-AT0-1A	■	39-41
				C 	ADP16K4-AT0-1C		
				E 	ADP16K4-AT0-1E		
				F 	ADP16K4-AT0-1F		
				Momentary	U 		
	Flange		Alternate	A 	ADP16K4-AA0-1A	■	39-41
				C 	ADP16K4-AA0-1C		
				E 	ADP16K4-AA0-1E		
				F 	ADP16K4-AA0-1F		
				Momentary	U 		

Buzzer					
Series	Head Shape			Color	Page No.
	Round	Square	Rectangular		
ADP16B Series (IP40)				■	44-46
	ADP16B4-0R0-0140	ADP16B4-0S0-0140	ADP16B4-0T0-0140		

**DESCRIPTION**

- \* Multiple designs to fit with different panel with options for continuous or intermittent tone.
- \* Available Size : Rectangular 18x24 mm  
Square 18x18 mm  
Round diameter : ~18mm
- \* IP 40 protection degree enable the device to be used in equipments of various fields.
- \* The sound pressure 80 db at a distance of 0.1m.
- \* Approvals: UL/CUL/VDE/CE pending

**SPECIFICATIONS**

Rated Voltage	DC12~24V	Terminal	Soldering type
Rated Current	min100mA~max3A	Wire Range	1x1.5mm <sup>2</sup> max
Electrical Life	1000hr(continuous tone)	Cable Range	2x0.75mm <sup>2</sup> /1x1.0mm <sup>2</sup> Max
Sound Pressure	80dB(continuous tone)	Storage Temperature	-40°C~+70°C
Sound Frequency	2±0.5KHzr	Operating Temperature	-25°C~+55°C
Flickering Cycle	55cycles±10%(Intermittent tone)	Degree of Protection	IP40

## ORDER INFORMATION

MODEL FORMAT ADP16B4-0**1**0-0**2**40

### **1** HEAD SHAPE

- R : ROUND
- S : SQUARE
- T : RECTANGULAR

### **2** VOICE

- 1 : CONTINUOUS TONE
- 2 : INTERMITTENT TONE

### CURRENT RATING

DC 12-24V



unit: mm

SHAPE			
DIMENSIONS	Ø 18	18x18	18x24

**HEAD SHAPE**

ADP16B4-0R0-0140

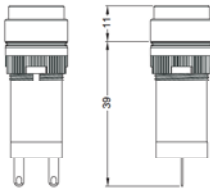

ADP16B4-0S0-0140

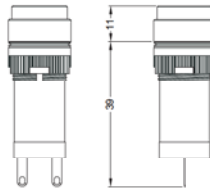

ADP16B4-0T0-0140

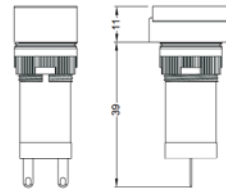

**MOUNTING DIMENSIONS**

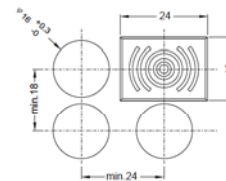
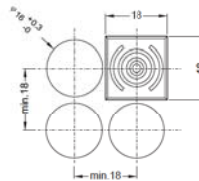
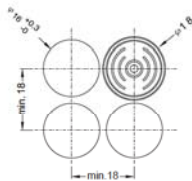

Panel Thickness 0.5 To 5.0