



**finder**<sup>®</sup>  
SWITCH TO THE FUTURE

# Energy meters

**7E**  
SERIES



Panels for electrical distribution



Control panels



Electrical energy control



Industrial robots



Road / tunnel lighting



Elevators and lifts





**kWh Energy meter 1-phase with electro-mechanical display and SO pulse output**

**Type 7E.12.8.230.0002**

10 (25) A, kWh, No MID, horizontal display

**Type 7E.13.8.230.0010**

5 (32) A, kWh, MID, 1 module wide

**Type 7E.16.8.230.0010**

10 (65) A, kWh, MID, horizontal display

- Complies with EN 62053-21 and EN 50470
- Certified by PTB (7E.13 and 7E.16)  
(Physikalisch - Technischen Bundesanstalt)
- Accuracy class 1/B
- Protection class II
- SO pulse output for remote energy monitoring according to EN 62053-31
- Tamper-proof cover with lead seal facility available as an accessory
- Space saving small size
- 35 mm rail (EN 60715) mount

**7E.12.8.230.0002**



- Nominal current 10 A (25 A Maximum)
- 1-phase 230 V AC
- SO pulse output
- 35 mm wide

**7E.13.8.230.0010**



- Nominal current 5 A (32 A Maximum)
- MID certified (50 Hz)
- 1-phase 230 V AC
- SO pulse output
- 17.5 mm wide

**7E.16.8.230.0010**



- Nominal current 10 A (65 A Maximum)
- MID certified (50 Hz)
- 1-phase 230 V AC
- SO pulse output
- 35 mm wide

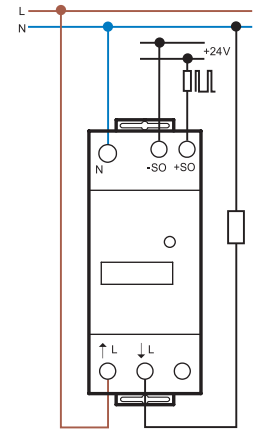
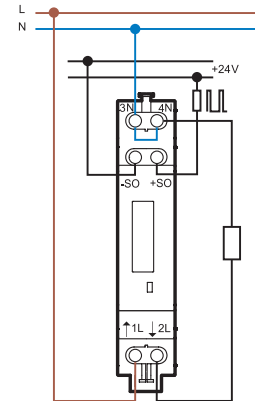
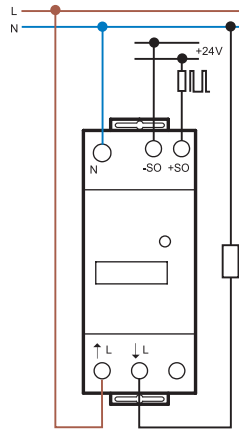

For outline drawing see page 15

**Specification**

Nominal/Maximum current	A	10/25	5/32	10/65
Minimum measured current	A	0.04	0.02	0.04
Current range (within accuracy class)	A	0.5...25	0.25...32	0.5...65
Maximum peak current	A	750 (10 ms)	960 (10 ms)	1950 (10 ms)
Supply (& monitored) voltage (U <sub>N</sub> )	V AC	230	230	230
Operating range		(0.8...1.15)U <sub>N</sub>	(0.8...1.15)U <sub>N</sub>	(0.8...1.15)U <sub>N</sub>
Frequency	Hz	50	50	50
Power consumption	W	< 0.5	< 0.4	< 0.5
Display (digit height 4 mm)		Six digit counter, red decimal digit	Seven digit counter, red decimal digit	
Max. totalising count/Min. increment	kWh	99 999.9/0.1	999 999.9/0.1	999 999.9/0.1
LED-Pulses per kWh		2000	2000	1000
<b>Open collector- output specification (SO+/SO-)</b>				
Voltage (external supply)	V DC	5...30	5...30	5...30
Maximum current	mA	20	20	20
Maximum leakage current @ 30 V/25 °C	µA	10	10	10
Pulses per kWh		1000	1000	1000
Pulse length	ms	50	50	50
Internal series resistance	Ω	100	100	100
Maximum cable length @ 30 V/20 mA	m	1000	1000	1000
<b>Technical data</b>				
Accuracy class		1	B	B
Ambient temperature (Within accuracy class)	°C	-10...+55	-10...+55	-10...+55
Protective class		II	II	II
Protection category: Housing/terminals		IP 50/IP 20	IP 50/IP 20	IP 50/IP 20
<b>Approvals</b> (according to type)		<b>CE</b>	<b>CE PTB</b>	

**kWh Energy meter 3-phase  
MID with electromechanical display and SO  
pulse output**
**Type 7E.36.8.400.0010**
**10 (65) A, kWh, MID**
**Type 7E.36.8.400.0012**
**10 (65) A, kWh, dual tariff, MID**

- Complies with EN 62053-21 and EN 50470
- Certified by PTB  
(Physikalisch - Technischen Bundesanstalt)
- Accuracy class B
- Protection class II
- SO pulse output for remote energy monitoring according to EN 62053-31
- Tamper-proof cover with lead seal facility available as an accessory
- 35 mm rail (EN 60715) mount

**7E.36.8.400.0010**

- Nominal current 10 A (65 A Maximum)
- MID certified (50 Hz)
- 3-phase
- SO pulse output
- 70 mm wide

**7E.36.8.400.0012**

- Nominal current 10 A (65 A Maximum)
- MID certified (50 Hz)
- 3-phase
- SO pulse output
- Dual tariff (Day and Night)
- 70 mm wide

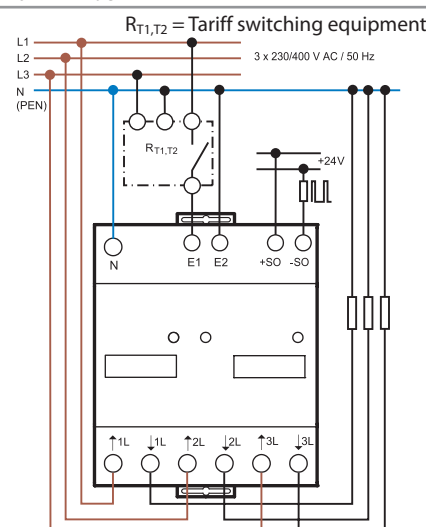
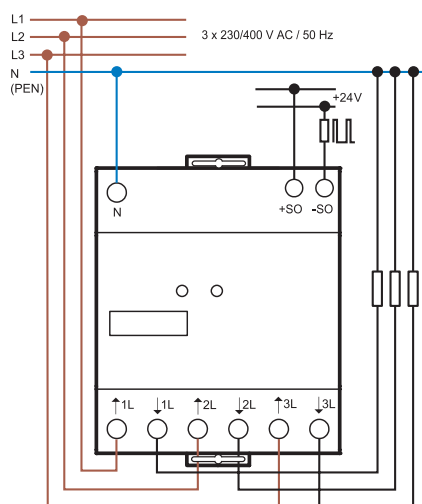

For outline drawing see page 15

**Specification**

Nominal/Maximum current	A	10/65	10/65
Minimum measured current	A	0.04	0.04
Current range (within accuracy class)	A	0.5...65	0.5...65
Maximum peak current	A	1950 (10 ms)	1950 (10 ms)
Supply (& monitored) voltage ( $U_N$ )	V AC	3 x 230	3 x 230
Operating range		$(0.8...1.15)U_N$	$(0.8...1.15)U_N$
Frequency	Hz	50	50
Power consumption per phase	W	< 1.5	< 1.5
Display (digit height 4 mm)		Seven digit counter, red decimal digit	
Max. totalising count/Min. increment	kWh	999 999.9/0.1	999 999.9/0.1
LED-Pulses per kWh		100	100
<b>Open collector- output specification (SO+/SO-)</b>			
Voltage (external supply)	V DC	5...30	5...30
Maximum current	mA	20	20
Maximum leakage current @ 30 V/25 °C	µA	10	10
Pulses per kWh		100	100
Pulse length	ms	50	50
Internal series resistance	Ω	100	100
Maximum cable length @ 30 V/20 mA	m	1000	1000
<b>Technical data</b>			
Accuracy class		B	B
Ambient temperature	°C	-10...+55	-10...+55
Protective class		II	II
Protection category: Housing/terminals		IP 50/IP 20	IP 50/IP 20
<b>Approvals</b> (according to type)		<b>CE PTB</b>	

**Single-phase**

**Single-phase Bi-directional energy meters with backlit LCD display**

**Type 7E.64.8.230.0001**  
**kWh, kW, V**

- Display of active energy consumption (kWh)
- Scroll to view instantaneous voltage (V) and active power (kW)
- 7 digit backlit LCD display
- Class 1 accuracy according to EN 62053-21
- SO output for remote energy monitoring according to EN 62053-31. Active energy (kWh) only

**Type 7E.64.8.230.0010**  
**Multifunction MID certified**

- Display of total or partial (resettable) energy consumption: kWh, kVAh or kvarh
- Scroll to view the following instantaneous values: V, A, PF, kW, kVA, kvar, Hz and direction of power flow
- 7 digit backlit LCD display
- Active power accuracy Class B according to EN 50470-3
- Programmable\* SO pulse output for remote energy monitoring according to EN 62053-31
- Accessories: sealable tamperproof terminal cover
- Protection category II
- 35 mm rail (EN 60715) mount

\* SO output can be associated with kWh, kVAh or kvarh.

For outline drawing see page 15

**Specification**

Reference/Maximum current $I_n/I_{max}$	A	5/40	5/40
Starting current $I_{st}$	A	0.02	0.02
Minimum measured current $I_{min}$	A	0.25	0.25
Current range (within accuracy class)	A	0.5...40	0.5...40
Maximum peak current	A	1200 (10 ms)	1200 (10 ms)
Supply (& monitored) voltage $U_N$	V AC	230	230
Operating range		$(0.8...1.2)U_N$	$(0.8...1.2)U_N$
Frequency	Hz	50/60	50/60
Power consumption	W/VA	$\leq 0.5/1.5$	$\leq 0.5/1.5$
Display	Seven digit counter - backlit LCD display		
Max. totalising count/Min. increment	kWh	999 999.9/0.1	999 999.9/0.1
LED pulses per kWh		5000	5000
LED pulse length	ms	$4\pm 0.5$	$4\pm 0.5$

**Output specification (SO+/SO-)**

Number/Type		1 opto-isolated output	1 opto-isolated output
Voltage range/Maximum current (conforming to EN 62053-1)	V DC/mA	3.3...27/1...27	3.3...27/1...27
Pulses per kWh*	Imp/kWh*	1000	1000
Pulse length	ms	$100 \pm 0.5$	$100 \pm 0.5$
Maximum cable length	m	1000	1000

**Technical data**

Accuracy class EN 62053-21 (non MID)/ EN 50470-3 (MID)		1	B
Ambient temperature (Within accuracy class)	°C	-25...+55	-25...+55
Protective class		II	II
Protection category: Housing/terminals		IP 50/IP 20	IP 50/IP 20

**Approvals** (according to type)



**NEW 7E.64.8.230.0001**



- Reference current 5 A (40 A Maximum)
- 1-phase 230 V AC
- kWh + instantaneous voltage & kW, V

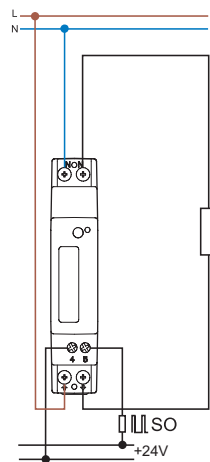

**NEW 7E.64.8.230.0010**



- Reference current 5 A (40 A Maximum)
- 1-phase 230 V AC
- kWh, kVAh or kvarh + instantaneous V, A, PF, kW, kVA, kvar & Hz
- MID certified

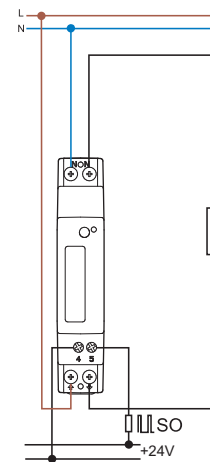

**Three-phase**

**Multifunction Dual tariff energy meters**  
**Bi-directional, MID certified, two SO outputs**  
**with backlit LCD display for 3 or 4 wire systems**  
**Infra-red communications port**

**Type 7E.78.8.400.0112**

**Direct connection up to 80 A, dual tariff**

**Type 7E.86.8.400.0112**

**6 A direct connection, up to 50 000 A using**  
**current transformer, dual tariff**

- Display of total or partial (resettable) energy consumption: kWh, kVAh or kvarh - for both T1 and T2 tariffs - for the total system or per phase
- Scroll to view the following instantaneous values: V, A, PF, kW, kVA, kvar, Hz and direction of power flow
- Fault indication in the event of loss or incorrect phase sequence
- 8 digit backlit LCD display
- Active power accuracy Class B according to EN 50470-3
- Reactive power accuracy Class 2 according to EN 62053-23
- Two programmable\*\* SO pulse outputs for remote energy monitoring according to EN 62053-31
- Infra-red communications port for data exchange with various field protocols, using optional modules
- Protection category II
- Accessories: sealable tamperproof terminal cover
- 35 mm rail (EN 60715) mount

\* Minimum CT ratio: 1:1  
 Maximum CT ratio: 10 000:1  
 CT full scale programmable: 1 or 5 A

\*\* SO output can be associated with kWh, kVAh or kvarh.

For outline drawing see page 15

**Specification**

Reference/Maximum current $I_n/I_{max}$	A	5/80	1/6
Starting current $I_{st}$	A	0.02	0.002
Minimum measured current $I_{min}$	A	0.25	0.01
Current range (within accuracy class)	A	0.5...80	0.05...6
Maximum peak current	A	2400 (10 ms)	120 (500 ms)
Supply (& monitored) voltage $U_N$	V AC	3 x 230/400...3 x 240/415	3 x 230/400...3 x 240/415
Operating range		$(0.8...1.2)U_N$	$(0.8...1.2)U_N$
Frequency	Hz	50/60	50/60
Power consumption per phase	W/VA	$\leq 0.5/7.5$	$\leq 0.5/7.5$
CT burden (per phase)	VA	—	0.04
Display	Eight digit counter - backlit LCD display		
Max. totalising count/Min. increment	kWh	999 999.99/0.01	999 999.99/0.01
LED pulses per kWh		1000	10 000
LED pulse length	ms	10±0.5	10±0.5
<b>Output specification (SO+/SO-)</b>			
Number/Type		2 opto-isolated outputs	2 opto-isolated outputs
Maximum values (conforming to EN 62053-31)	V AC-DC/mA	250/100	250/100
Pulses per kWh**	Imp/kWh**	100	See table page 13
Pulse length	ms	50 ± 2	50 ± 2
Maximum cable length (30 V/20 mA)	m	1000	1000
<b>Tariff input - opto-isolated</b>			
Voltage range	V AC/DC	80...275	80...275
<b>Technical data</b>			
Accuracy class EN 50470-3 (MID)		B	B
Ambient temperature	°C	-25...+55 °C	-25...+55 °C
Protective class		II	II
Protection category: Housing/terminals		IP 50/IP 20	IP 50/IP 20

**Approvals** (according to type)



**NEW 7E.78.8.400.0112**



- Reference current 5 A (80 A Maximum)
- Three-phase systems - 3 or 4 wire
- Dual tariff
- MID certified

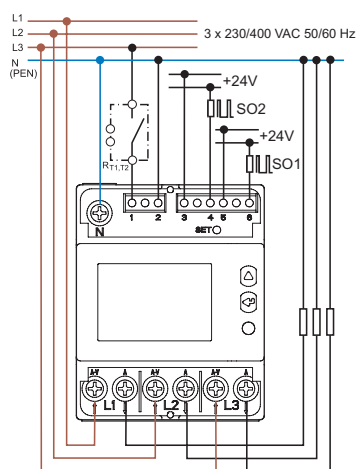

R<sub>T1,T2</sub> = Tariff switching equipment

**NEW 7E.86.8.400.0112**



- Reference current 1 A (6 A Maximum)
- Three-phase systems - 3 or 4 wire
- Usable with current transformer\*
- Programmable CT secondary\*
- Dual tariff
- MID certified

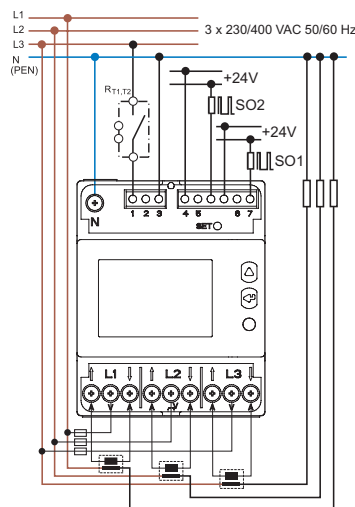

R<sub>T1,T2</sub> = Tariff switching equipment

**Single-phase**

**Multifunction, Bi-directional energy meter  
MID certified with RS485 Modbus integrated  
interface and backlit LCD display**

- Display of total or partial (resettable) energy consumption: kWh, kVAh or kvarh
- Scroll to view the following instantaneous values: V, A, PF, kW, kVA, kvar, Hz and direction of power flow
- 7 digit backlit LCD display
- Active power accuracy Class B according to EN 50470-3
- RS485 Modbus integrated communications port
- Programmable\*\* SO pulse output for remote energy monitoring according to EN 62053-31
- Accessories: sealable tamperproof terminal cover
- Protection category II
- 35 mm rail (EN 60715) mount

\* Default transmission baud rate: 19 200 bps  
\*\* SO output can be associated with kWh, kVAh or kvarh.

**NEW 7E.64.8.230.0210**



- Reference current 5 A (40 A Maximum)
- RS485 Modbus integrated interface
- 1-phase 230 V 50/60 Hz
- MID certified

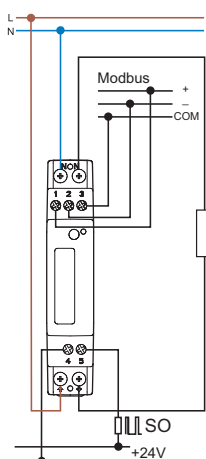

For outline drawing see page 16

**Specification**

Reference/Maximum current $I_N/I_{max}$	A	5/40
Starting current $I_{st}$	A	0.02
Minimum measured current $I_{min}$	A	0.25
Current range (within accuracy class)	A	0.5...40
Maximum peak current	A	1200 (10 ms)
Supply (& monitored) voltage $U_N$	V AC	230
Operating range		$(0.8...1.2)U_N$
Frequency	Hz	50/60
Power consumption	W/VA	$\leq 0.5/1.5$
Display		Seven digit counter - backlit LCD display
Max. totalising count/Min. increment	kWh	999 999.9/0.1
LED pulses per kWh		5000
LED pulse length	ms	$4 \pm 0.5$

**Modbus technical data**

Bus System		RS485 Modbus
Conforms to standard		EIA RS485
Max. bus length	m	1000
Max. Modbus energy meters connectable		32
Baud rate*	Baud	2400, 4800, 9600, 19 200, 38 400

**Output specification (SO+/SO-)**

Number/Type		1 opto-isolated output
Voltage range/Maximum current (conforming to EN 62053-31)	V DC/mA	$3.3...27/1...27$
Pulses per kWh**	Imp/kWh**	1000
Pulse length	ms	$100 \pm 2$

**Technical data**

Accuracy class		B
Ambient temperature (Within accuracy class)	°C	$-25...+55$
Protective class		II
Protection category: Housing/terminals		IP 50/IP 20

**Approvals (according to type)**



**Three-phase**

**Multifunction Dual tariff energy meters**  
**Bi-directional, MID certified with RS485**  
**Modbus integrated interface, single SO output**  
**and backlit LCD display for 4 wire systems**

**Type 7E.78.8.400.0212**

**Direct connection up to 80 A, dual tariff**

**Type 7E.86.8.400.0212**

**6 A direct connection, up to 50 000 A using**  
**current transformer, dual tariff**

- Display of total or partial (resettable) energy consumption: kWh, kVAh or kvarh - for both T1 and T2 tariffs - for the total system or per phase
- Scroll to view the following instantaneous values: V, A, PF, kW, kVA, kvar, Hz and direction of power flow
- Fault indication in the event of loss or incorrect phase sequence
- 8 digit backlit LCD display
- RS485 Modbus integrated communications port
- Programmable\*\*\* SO pulse output for remote energy monitoring according to EN 62053-31
- Active power accuracy Class B according to EN 50470-3
- Reactive power accuracy Class 2 according to EN 62053-23
- Protection category II
- Accessories: sealable tamperproof terminal cover
- 35 mm rail (EN 60715) mount

\* Minimum CT ratio: 1:1

Maximum CT ratio: 10 000:1

CT secondary programmable: 1 or 5 A

\*\* Default transmission baud rate: 19 200 bps

\*\*\* SO output can be associated with kWh, kVAh or kvarh.

For outline drawing see page 16

**Specification**

Reference/Maximum current $I_n/I_{max}$	A	5/80	1/6
Starting current $I_{st}$	A	0.02	0.002
Minimum measured current $I_{min}$	A	0.25	0.01
Current range (within accuracy class)	A	0.5...80	0.05...6
Maximum peak current	A	2400 (10 ms)	120 (500 ms)
Supply (& monitored) voltage $U_N$	V AC	3 x 230/400...3 x 240/415	3 x 230/400...3 x 240/415
Operating range		$(0.8...1.2)U_N$	$(0.8...1.2)U_N$
Frequency	Hz	50/60	50/60
Power consumption per phase	W/VA	$\leq 1/3.5$	$\leq 1/3.5$
CT burden (per phase)	VA	—	0.04

Display Eight digit counter - backlit LCD display

Max. totalising count/Min. increment	kWh	999 999.99/0.01	999 999.99/0.01
LED pulses per kWh		1000	10 000
LED pulse length	ms	10±0.5	10±0.5

**Modbus technical data**

Bus system		RS485 Modbus	RS485 Modbus
Conforms to standard		EIA RS485	EIA RS485
Max. bus length	m	1000	1000
Max. Modbus energy meters connectable		32	32
Baud rate**	Baud	300...57 600	300...57 600

**Output specification (SO+/SO-)**

Number/Type		1 opto-isolated output	1 opto-isolated output
Voltage range/Maximum current (conforming to EN 62053-31)	V DC/mA	3.3...27/1...27	3.3...27/1...27
Pulse per kWh***	Imp/kWh***	100	See table page 13
Pulse length	ms	50 ± 2	50 ± 2

**Tariff input - opto-isolated**

Voltage range	V AC/DC	80...275	80...275
---------------	---------	----------	----------

**Technical data**

Accuracy class		B	B
Ambient temperature (Within accuracy class)	°C	-25...+55	-25...+55
Protective class		II	II
Protection category: Housing/terminals		IP 50/IP 20	IP 50/IP 20

**Approvals** (according to type)

**NEW 7E.78.8.400.0212**

- Reference current 5 A (80 A Maximum)
- RS485 Modbus integrated interface
- Three-phase systems - 4 wire
- Dual tariff
- MID certified

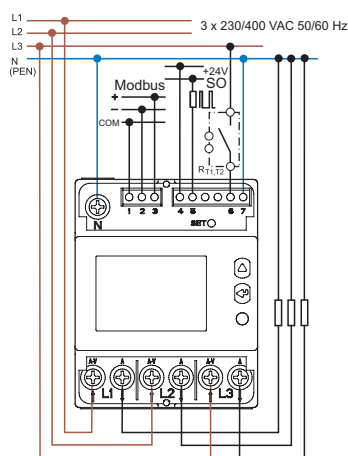

R<sub>T1,T2</sub> = Tariff switching equipment

**NEW 7E.86.8.400.0212**

- Reference current 1 A (6 A Maximum)
- RS485 Modbus integrated interface
- Three-phase systems - 4 wire
- Usable with current transformer\*
- Programmable CT secondary\*
- Dual tariff
- MID certified

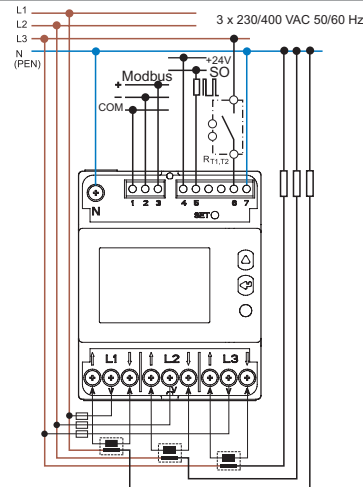

R<sub>T1,T2</sub> = Tariff switching equipment



**Single-phase**

**Multifunction energy meter  
Bi-directional, MID certified with M-Bus  
integrated interface and backlit LCD display**

- Display of total or partial (resettable) energy consumption: kWh, kVAh or kvarh
- Scroll to view the following instantaneous values: V, A, PF, kW, kVA, kvar, Hz and direction of power flow
- 7 digit backlit LCD display
- Active power accuracy Class B according to EN 50470-3
- M-Bus integrated communications port
- Programmable\*\* SO pulse output for remote energy monitoring according to EN 62053-31
- Accessories: sealable tamperproof terminal cover
- Protection category II
- 35 mm rail (EN 60715) mount

\* Default transmission baud rate: 2400 bps

\*\* SO output can be associated with kWh, kVAh or kvarh.

**NEW 7E.64.8.230.0310**



- Reference current 5 A (40 A Maximum)
- M-Bus integrated interface
- 1-phase 230 V 50/60 Hz
- MID certified

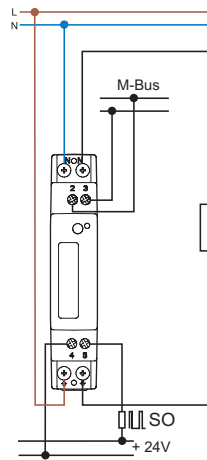

For outline drawing see page 16

**Specification**

Reference/Maximum current $I_n/I_{max}$	A	5/40
Starting current $I_{st}$	A	0.02
Minimum measured current $I_{min}$	A	0.25
Current range (within accuracy class)	A	0.5...40
Maximum peak current	A	1200 (10 ms)
Supply (& monitored) voltage $U_N$	V AC	230
Operating range		$(0.8...1.2)U_N$
Frequency	Hz	50/60
Power consumption per phase	W/VA	$\leq 0.5/1.5$
Display		Seven digit counter - backlit LCD display
Max. totalising count/Min. increment	kWh	999 999.9/0.1
LED pulses per kWh		5000
LED pulse length	ms	$4 \pm 0.5$

**M-bus technical data**

Bus System		M-Bus
Conforms to standard		EN 13757-1-2-3
Baud rate*	Baud	300, 2400, 9600

**Output specification (SO+/SO-)**

Number/Type		1 opto-isolated output
Voltage range/Maximum current (conforming to EN 62053-31)	V DC/mA	3.3...27/1...27
Pulses per kWh**	Imp/kWh**	1000
Pulse length	ms	$100 \pm 0.5$

**Technical data**

Accuracy class		B
Ambient temperature (Within accuracy class)	°C	-25...+55
Protective class		II
Protection category: Housing/terminals		IP 50/IP 20

**Approvals (according to type)**



**Three-phase**

**Multifunction Dual tariff energy meters**  
**Bi-directional, MID certified with M-Bus**  
**integrated interface, single SO output and**  
**backlit LCD display for 3 or 4 wire systems**

**Type 7E.78.8.400.0312**

**Direct connection up to 80 A, dual tariff**

**Type 7E.86.8.400.0312**

**6 A direct connection, up to 50 000 A using**  
**current transformer, dual tariff**

- Display of total or partial (resettable) energy consumption: kWh, kVAh or kvarh - for both T1 and T2 tariffs - for the total system or per phase
- Scroll to view the following instantaneous values: V, A, PF, kW, kVA, kvar, Hz and direction of power flow
- Fault indication in the event of loss or incorrect phase sequence
- 8 digit backlit LCD display
- M-Bus integrated communications port
- Programmable\*\*\* SO pulse output for remote energy monitoring according to EN 62053-31
- Active power accuracy Class B according to EN 50470-3
- Reactive power accuracy Class 2 according to EN 62053-23
- Protection category II
- Accessories: sealable tamperproof terminal cover
- 35 mm rail (EN 60715) mount

- \* Minimum CT ratio: 1:1  
Maximum CT ratio: 10 000:1  
CT secondary programmable: 1 or 5 A
- \*\* Default transmission baud rate: 2400 bps
- \*\*\* SO output can be associate with kWh, kVAh or kvarh.

For outline drawing see page 16

**Specification**

Reference/Maximum current $I_n/I_{max}$	A	5/80	1/6
Starting current $I_{st}$	A	0.02	0.002
Minimum measured current $I_{min}$	A	0.25	0.01
Current range (within accuracy class)	A	0.5...80	0.05...6
Maximum peak current	A	2400 (10 ms)	120 (500 ms)
Supply (& monitored) voltage $U_N$	V AC	3 x 230/400...3 x 240/415	3 x 230/400...3 x 240/415
Operating range		(0.8...1.2) $U_N$	(0.8...1.2) $U_N$
Frequency	Hz	50/60	50/60
Power consumption per phase	W/VA	≤ 0.5/7.5	≤ 0.5/7.5
CT burden (per phase)	VA	—	0.04
Display	Eight digit counter - backlit LCD display		
Max. totalising count/Min. increment	kWh	999 999.99/0.01	999 999.99/0.01
LED pulses per kWh		1000	10 000
LED pulse length	ms	10±0.5	10±0.5
<b>M-bus technical data</b>			
Bus system		M-Bus	M-Bus
Conforms to standard		EN 13757-1-2-3	EN 13757-1-2-3
Baud rate**	Baud	300...9600	300...9600
<b>Output specification (SO+/SO-)</b>			
Number/Type		1 opto-isolated output	1 opto-isolated output
Voltage range/Maximum current (conforming to EN 62053-31)	V DC/mA	3.3...27/1...27	3.3...27/1...27
Pulses per kWh***	Imp/kWh***	100	See table page 13
Pulse length	ms	50 ± 2	50 ± 2
<b>Tariff input - opto-isolated</b>			
Voltage range	V AC/DC	80...275	80...275
<b>Technical data</b>			
Accuracy class		B	B
Ambient temperature (Within accuracy class)	°C	-25...+55	-25...+55
Protective class		II	II
Protection category: Housing/terminals		IP 50/IP 20	IP 50/IP 20
<b>Approvals (according to type)</b>		CE	

**NEW 7E.78.8.400.0312**

- Reference current 5 A (80 A Maximum)
- M-Bus integrated interface
- Three-phase systems programmable 3 or 4 wire
- Dual tariff
- MID certified

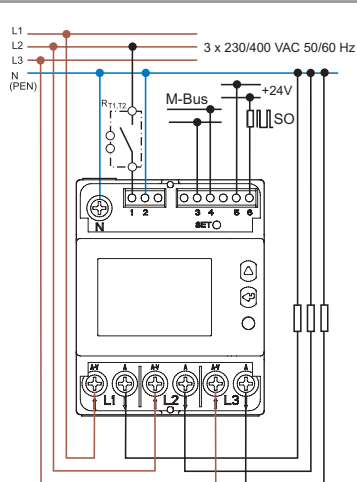

R<sub>T1,T2</sub> = Tariff switching equipment

**NEW 7E.86.8.400.0312**

- Reference current 1 A (6 A Maximum)
- M-Bus integrated interface
- Three-phase systems programmable 3 or 4 wire
- Usable with current transformer\*
- Programmable CT secondary\*
- Dual tariff
- MID certified

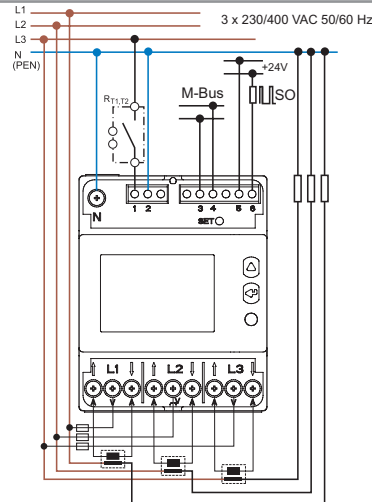

R<sub>T1,T2</sub> = Tariff switching equipment

**Three-phase**

**Multifunction energy meter  
Bi-directional, MID certified with Ethernet  
Modbus TCP integrated interface and backlit  
LCD display for 4 wire systems**

**Type 7E.78.8.400.0410:  
Direct connection up to 80 A**

**Type 7E.86.8.400.0410:  
6 A direct installation, up to 50 000 A using  
current transformer**

- Display of total or partial (resettable) energy consumption: kWh, kVAh or kvarh - for the total system or per phase
- Scroll to view the following instantaneous values: V, A, PF, kW, kVA, kvar, Hz and direction of power flow
- Fault indication in the event of loss or incorrect phase sequence
- 8 digit backlit LCD display
- Ethernet Modbus TCP integrated communications port
- Programmable\*\* SO pulse output for remote energy monitoring according to EN 62053-31
- Active power accuracy Class B according to EN 50470-3
- Reactive power accuracy Class 2 according to EN 62053-23
- Protection category II
- Accessories: sealable terminal cover tamper
- 35 mm rail (EN 60715) mount

- \* Minimum CT ratio: 1:1  
Maximum CT ratio: 10 000:1  
CT secondary programmable: 1 or 5 A
- \*\* SO output can be associate with kWh, kVAh or kvarh.

For outline drawing see page 16

**Specification**

Reference/Maximum current $I_n/I_{max}$	A	5/80	1/6
Starting current $I_{st}$	A	0.02	0.002
Minimum measured current $I_{min}$	A	0.25	0.01
Current range (within accuracy class)	A	0.5...80	0.05...6
Maximum peak current	A	2400 (10 ms)	120 (500 ms)
Supply (& monitored) voltage $U_N$	V AC	3 x 230/400...3 x 240/415	3 x 230/400...3 x 240/415
Operating range		$(0.8...1.2)U_N$	$(0.8...1.2)U_N$
Frequency	Hz	50/60	50/60
Power consumption per phase	W/VA	$\leq 1/3.5$	$\leq 1/3.5$
CT burden (per phase)	VA	—	0.04
Display		Eight digit counter - backlit LCD display	
Max. totalising count/Min. increment	kWh	999 999.99/0.01	999 999.99/0.01
LED pulses per kWh		1000	10 000
LED pulse length	ms	10±0.5	10±0.5
<b>Ethernet technical data</b>			
Bus system		Ethernet TCP	Ethernet TCP
Protocol		Modbus TCP, HTTP, NTP; DHCP	Modbus TCP, HTTP, NTP; DHCP
Conforms to standard		IEEE 802.3	IEEE 802.3
Communication speed	Mbps	10/100	10/100
<b>Open collector- output specification (SO+/SO-)</b>			
Number/Type		1 opto-isolated output	1 opto-isolated output
Voltage range/Maximum current (conform to EN 62053-31)	V DC/mA	3.3...27/1...27	3.3...27/1...27
Pulses per kWh**	Imp/kWh**	100	See table page 13
Pulse length	ms	50 ± 2	50 ± 2
<b>Technical data</b>			
Accuracy class		B	B
Ambient temperature (Within accuracy class)	°C	-25...+55	-25...+55
Protective class		II	II
Protection category: Housing/terminals		IP 50/IP 20	IP 50/IP 20
<b>Approvals</b> (according to type)			

**NEW 7E.78.8.400.0410**



- Reference current 5 A (80 A Maximum)
- Ethernet Modbus TCP integrated interface
- Three-phase systems - 4 wire

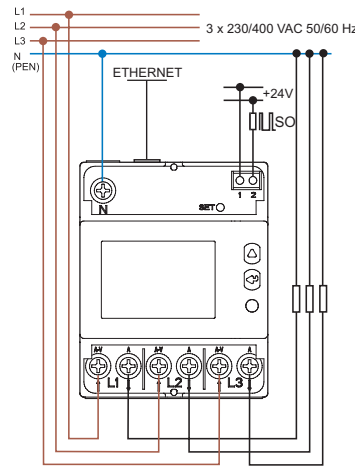

**NEW 7E.86.8.400.0410**



- Reference current 1 A (6 A Maximum)
- Ethernet Modbus TCP integrated interface
- Three-phase systems - 4 wire
- Usable with current transformer\*
- Full scale (FSA) programmable\*

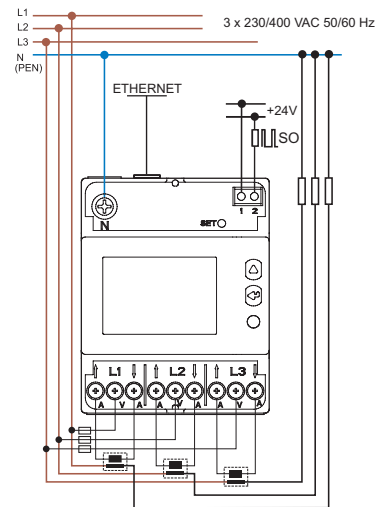

## Ordering information

Example: Energy meter 32 A/230 V AC, with PTB certified, with MID certification, Class B accuracy, for 35mm rail (EN 60715) mounting. Available with Tamper-proof lead sealed cover as accessory.

7 E . 1 3 . 8 . 2 3 0 . 0 0 1 0

**Series**
**Function**

1 = 1-phase

3 = 3-phase

**Current**

2 = 25 A

3 = 32 A

6 = 65 A

**Supply version**

8 = AC 50 Hz

**Option**

0 = SO +/- pulse output

**Special version**

0 = Standard

1 = MID compliant versions

**Option**

0 = Standard

2 = Standard (7E.12)

2 = Dual tariff (7E.36)

**Supply voltage**

230 = 230 V AC 50 Hz

400 = 3 x 230/400 V AC 50 Hz

**All versions/width**

7E.12.8.230.0002/35 mm



7E.13.8.230.0010/17.5 mm

7E.16.8.230.0010/35 mm

7E.36.8.400.0010/70 mm

7E.36.8.400.0012/70 mm

## E Technical data

<b>Insulation EN 62053-21</b>		<b>7E.12, 7E.13, 7E.16</b>		<b>7E.36</b>		
Insulation rated voltage	V	250		250		
Overvoltage category		IV		IV		
Insulation	between active parts and SO+/SO- terminals	kV (1.2/50 μs)	6		6	
	between adjacent phases	kV (1.2/50 μs)	—		6	
Insulation	between supply and SO+/SO-	V AC	4000		4000	
	between adjacent phases	V AC	—		4000	
Protection class		II		II		
<b>EMC Specification</b>		<b>Reference standard</b>				
Electrostatic discharge	contact discharge	EN 61000-4-2		8 kV		
	air discharge	EN 61000-4-2		15 kV		
Radio-Frequency Electromagnetic Field (80...1000)MHz		EN 61000-4-3		10 V/m		
Fast Transients (Burst) (5-50 ns, 5 kHz)	on Supply terminals	EN 61000-4-4		Class 4 (4 kV)		
	on SO+/SO- terminals	EN 61000-4-4		Class 4 (2 kV)		
Surge (1.2/50 μs)	on Supply terminals	EN 61000-4-5		Class 4 (4 kV)		
	on SO+/SO- terminals	EN 61000-4-5		Class 3 (1 kV)		
Radio-Frequency Common Mode (0.15...80)MHz on Supply terminals		EN 61000-4-6		10 V		
Radiated and Conducted Emission		EN 55022		Class B		
<b>Other data</b>						
Pollution degree		2				
Vibration resistance	(10...60)Hz	mm	0.075			
	(60...150)Hz	g	1			
Vibration resistance of the internal mechanical counter (10...500)Hz	g	2				
Shock resistance	g/18 ms	30				
Shock resistance of the internal mechanical counter	g/18 ms	350				
Power lost to the environment		<b>7E.12, 7E.13</b>	<b>7E.16</b>	<b>7E.36</b>		
	without current	W	0.4	0.4	1.5	
	with maximum current	W	1	2	6	
<b>Supply terminals</b>	Max. wire size		<b>7E.12, 7E.13</b>		<b>7E.16, 7E.36</b>	
			solid cable	stranded cable	solid cable	stranded cable
	mm <sup>2</sup>	1...6	0.75...4	1.5...16	1.5...16	
	AWG	18...10	18...12	16...6	16...6	
	Screw torque for I <sub>max</sub>	Nm	0.8...1.2		1.5...2	
	Screw	Pozi driv No.1, Flat No.1, 2				
<b>SO+/SO- terminals</b>	Max. wire size		solid cable	stranded cable	solid cable	stranded cable
		mm <sup>2</sup>	2.5	1.5	2.5	1.5
	AWG	14	16	14	16	
	Screw torque for I <sub>max</sub>	Nm	0.5		0.8	
	Screw	Pozi driv No.0, Flat No.1			Pozi driv No.0, Flat No.2	

## Ordering information - Energy meter

Example: 3-phase energy meter for current transformer operation (6A/400 V AC), with MID certification, Class B accuracy, for 35 mm rail (EN 60715) mounting. Supplied accessories: Tamper-proof lead sealed cover as accessory.

<b>7</b>	<b>E</b>	<b>.</b>	<b>8</b>	<b>.</b>	<b>6</b>	<b>.</b>	<b>8</b>	<b>.</b>	<b>4</b>	<b>0</b>	<b>0</b>	<b>.</b>	<b>0</b>	<b>1</b>	<b>1</b>	<b>2</b>
<b>Series</b>			<b>Function</b>			<b>Special version</b>			<b>Option</b>			<b>Special version</b>				
6 = 1-phase, backlit display 7 = 3-phase, backlit display, direct connection 8 = 3-phase, backlit display, for current transformer operation			0 = Standard 1 = Infra-red comms. port + two SO pulse outputs 2 = RS485 Modbus integrated interface + SO pulse output 3 = M-Bus integrated interface + SO pulse output 4 = Ethernet integrated interface plus SO pulse output			0 = Single tariff 1 = kWh only (0001) 2 = Dual tariff 3 = Panel mounting			0 = Standard 1 = Conforms to MID directive							
<b>Current</b>			<b>Supply version</b>			<b>Supply voltage</b>										
4 = 40 A 6 = 6 A (up to 50 000 A, using 7E.86 and CT) 8 = 80 A			8 = AC 50/60 Hz			230 = 230 V AC 50/60 Hz 400 = 3 x 230/415 V AC 50/60 Hz										

**Table 1**

Imp/kWh*	CT ratio
1000	1...4
200	5...24
40	25...124
8	125...624
1	625...3124
0.1	3125...10 000

\*Imp/kWh, Imp/kvarh, Imp/kVAh

### Available versions

Infra-red comms. port for use with communication modules

Modbus	M-Bus	Ethernet	SO only
7E.78.8.400.0112	7E.64.8.230.0310	7E.78.8.400.0410	7E.64.8.230.0001
7E.86.8.400.0112	7E.78.8.400.0212	7E.86.8.400.0410	7E.64.8.230.0010
7E.86.8.400.0212	7E.86.8.400.0312		

## Technical data

Insulation		7E.64.8.230.0xxx	7E.78.8.400.0xxx	7E.86.8.400.0xxx
Insulation rated voltage		V	250	250
Insulation	between active parts and SO+/SO- terminals	kV (1.2/50 μs)	6	
	between supply and Modbus, M-Bus terminal	kV (1.2/50 μs)	6	
	between adjacent phases	kV(1.2/50 μs)	n/a	
Insulation	between active parts and SO+/SO- terminals	V AC	4000	
	between supply and Modbus, M-Bus terminal	V AC	4000	
	between adjacent phases	V AC	n/a	
Protection class		II		
EMC Specification according to 61000-4-(2/3/4)		7E.64.8.230.0xxx	7E.78.8.400.0xxx	7E.86.8.400.0xxx
Electrostatic discharge	contact discharge	8 kV		
	air discharge	15 kV		
Radio frequency Electromagnetic field (80...2000)MHz		30 V/m		
Fast Transients (burst) (5-50 ns, 5 kHz)	on Supply terminals	4 kV		
	on SO+/SO- terminals	2 kV		
	Modbus, M-Bus terminal	2 kV		
Surge (1.2/50 μs)	on Supply terminals	4 kV		
	on SO+/SO- terminals	1 kV		
	Modbus, M-Bus terminal	1 kV		
Other data		7E.64.8.230.0xxx	7E.78.8.400.0xxx	7E.86.8.400.0xxx
Pollution degree		2		
Vibration resistance		EN 60068-2-6	EN 60068-2-6	EN 60068-2-6
Shock resistance		EN 60068-2-27	EN 60068-2-27	EN 60068-2-27
Power lost to the environment	Max value per phase	0.5W/1.5 VA	1W/7.5VA	1W/7.5VA
	CT burden	—	—	0.04 VA/per phase
Supply terminals		7E.64.8.230.0xxx	7E.78.8.400.0xxx	7E.86.8.400.0xxx
Max. wire size	mm <sup>2</sup>	solid cable	solid cable	solid cable
		stranded cable	stranded cable	stranded cable
	AWG	—	—	—
Screw torque for I <sub>max</sub>	mm <sup>2</sup>	max 6	max 35	max 6
		1.5...6	1.5...35	1.5...6
	AWG	—	—	—
SO+/SO- terminals, RS485 Modbus, M-Bus		7E.64.8.230.0xxx	7E.78.8.400.0xxx	7E.86.8.400.0xxx
Max. wire size	mm <sup>2</sup>	solid cable	solid cable	solid cable
		stranded cable	stranded cable	stranded cable
	AWG	—	—	—
Screw torque	mm <sup>2</sup>	max 2.5	max 2.5	max 2.5
	AWG	—	—	—
Screw torque	Nm	0.5	0.5	0.5

## Mechanical Display Type 7E.12, 7E.13, 7E.16, 7E.36

### LED indication (Normal operation)

Type	Energy consumption			Pulses per kWh	Pulse space	The LED Pulse rate represents the instantaneous power being consumed, according to the following
	None	Low	High			
7E.12 7E.13				2000	100 ms	$kW = (\text{number of pulse per Minute}) / 33.3$
7E.16				1000	100 ms	$kW = (\text{number of pulse per Minute}) / 16.7$
7E.36				100	150 ms	$kW = (\text{number of pulse per Minute}) / 1.7$

### LED indication (Abnormal operation)

Status indicates errors of installation, as below

#### Type 7E.12, 7E.13, 7E.16

Device ON, incorrect connection (L-N inverted).

Mark = 600 ms, Space = 600 ms



#### Type 7E.36

Mark = 100 ms,

Phase L1 ↑ L1 ↓ inverted or loss

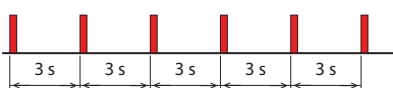

Phase L1 ↑ L1 ↓ and L2 ↑ L2 ↓ inverted or loss

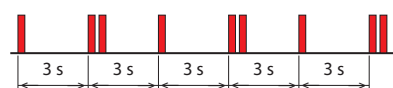

Phase L2 ↑ L2 ↓ inverted or loss

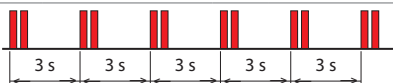

Phase L1 ↑ L1 ↓ and L3 ↑ L3 ↓ inverted or loss

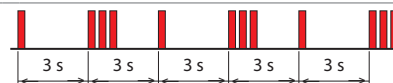

Phase L3 ↑ L3 ↓ inverted or loss

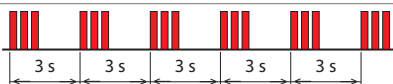

Phase L2 ↑ L2 ↓ and L3 ↑ L3 ↓ inverted or loss

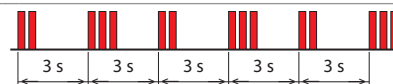

Phase L1 ↑ L1 ↓ and L2 ↑ L2 ↓ and L3 ↑ L3 ↓ inverted or loss

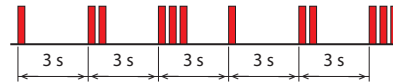

## SO+/SO- Open collector output wiring diagram Type 7E.12, 7E.13, 7E.16, 7E.36

The pulsating open collector output available at terminals SO+ and SO- can be interfaced with the input of a computer, plc or other energy management equipment to allow the remote monitoring of energy consumed.

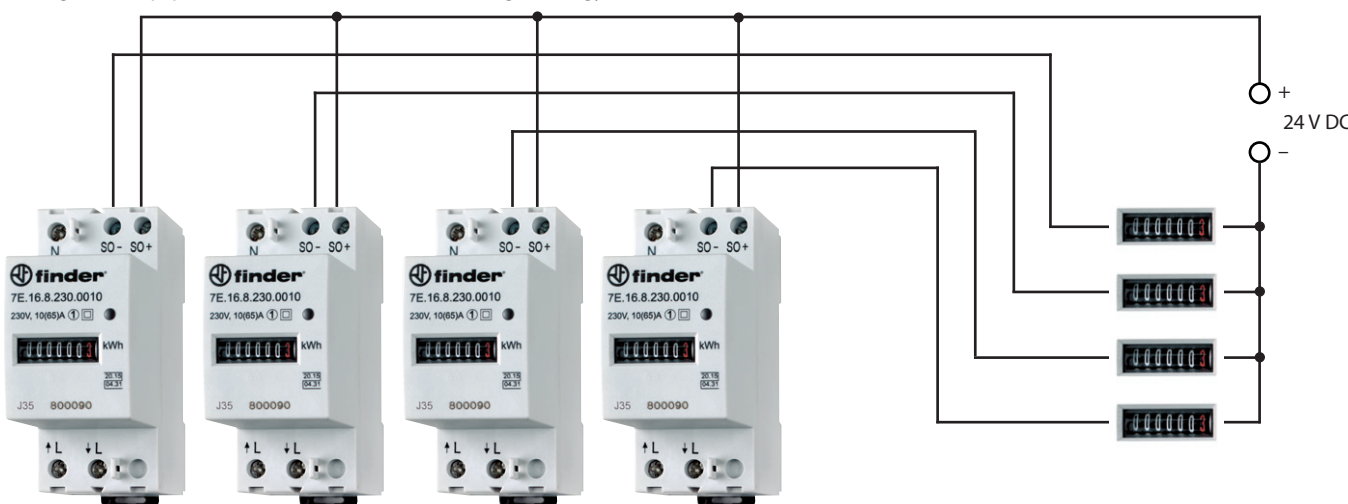

Energy meters – at difference locations  
(Note: Both Single and Dual tariff meters provide only a single pulsating output)

Central monitoring/management system  
(max. 20 mA for each input)

### SO-Output Type 7E.12, 7E.13, 7E.16

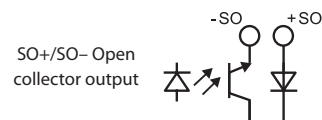

### SO-Output Type 7E.36

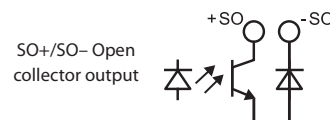

**Outline drawing**

Type 7E.12.8.230.0002/7E.16.8.230.0010

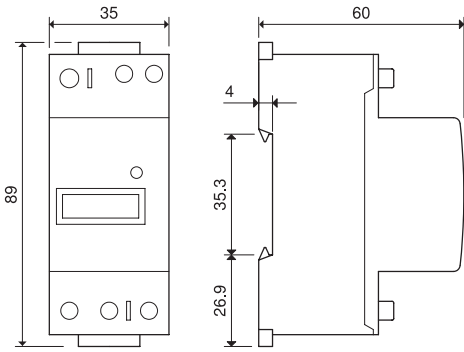

Type 7E.13.8.230.0010

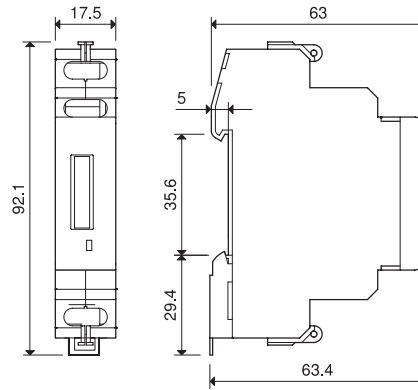

Type 7E.36.8.400.0010

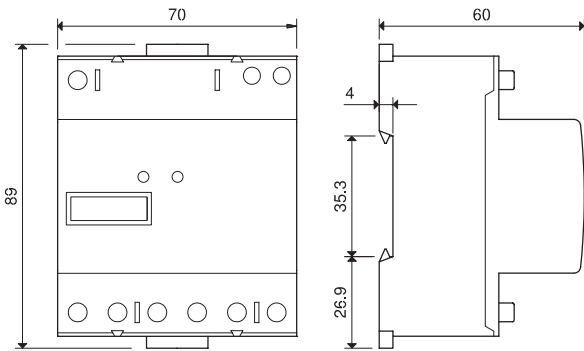

Type 7E.36.8.400.0012

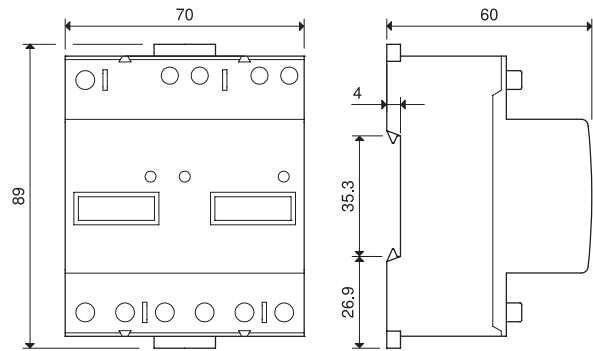

Type 7E.64.8.230.0001

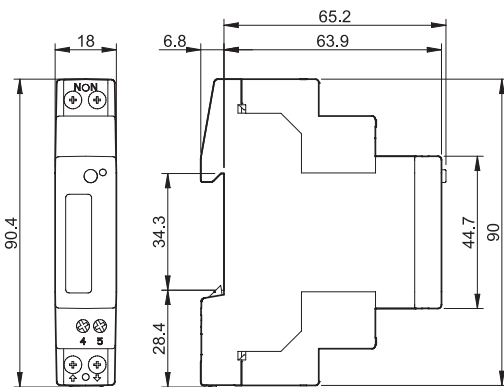

Type 7E.64.8.230.0010

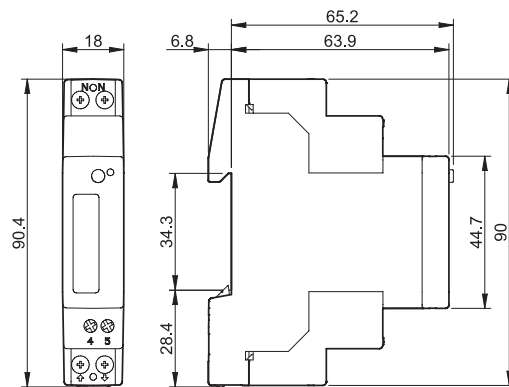

Type 7E.78.8.400.0112

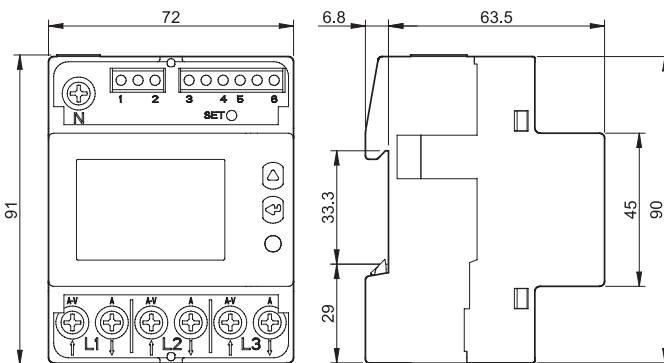

Type 7E.86.8.400.0112

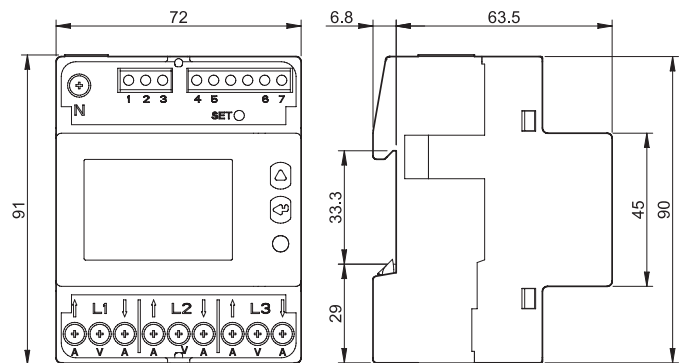

## Outline drawing

Type 7E.64.8.230.0210

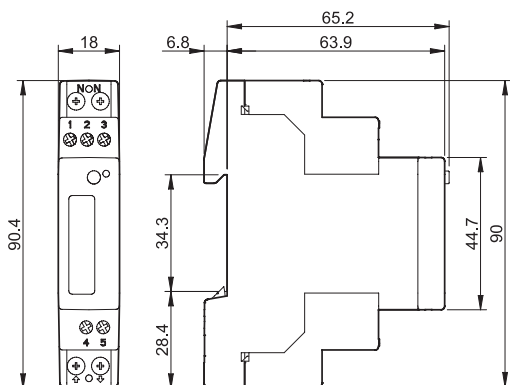

Type 7E.64.8.230.0310

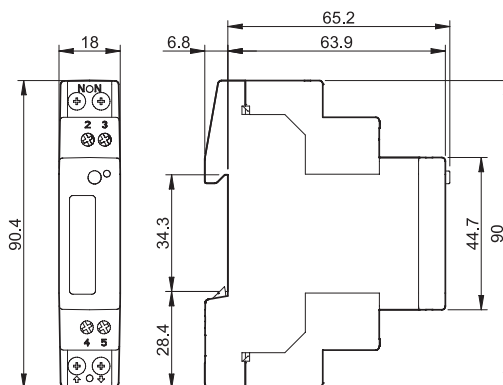

Type 7E.78.8.400.0212

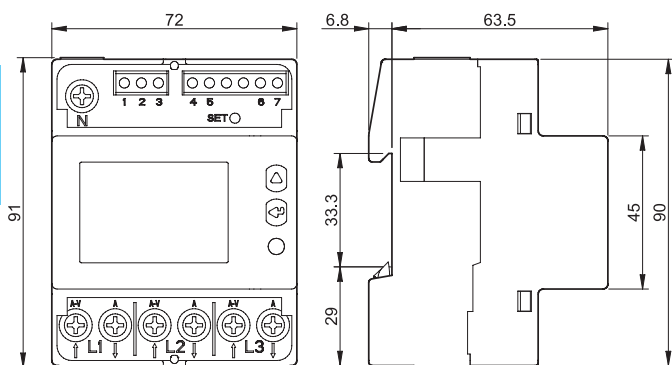

Type 7E.86.8.400.0212

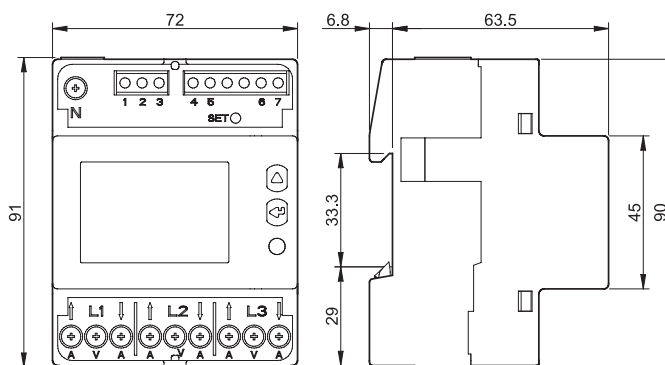

Type 7E.78.8.400.0312

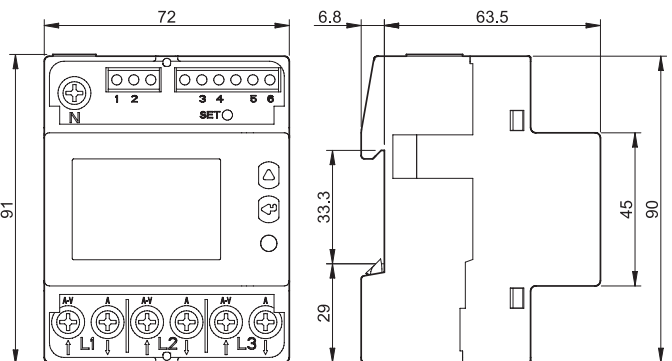

Type 7E.86.8.400.0312

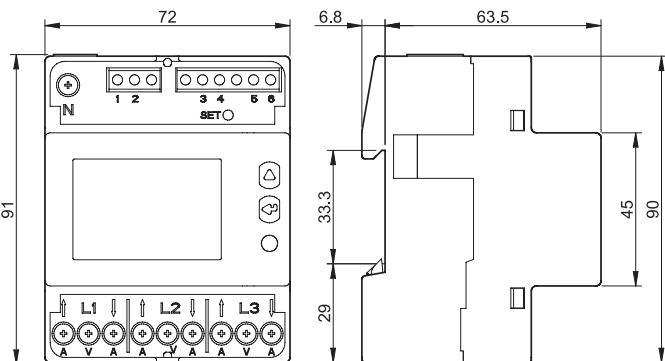

Type 7E.78.8.400.0410

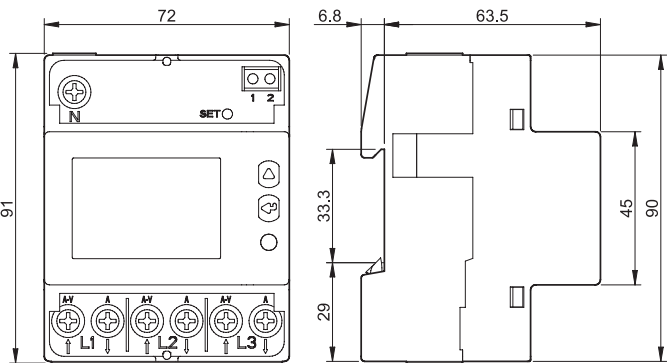

Type 7E.86.8.400.0410

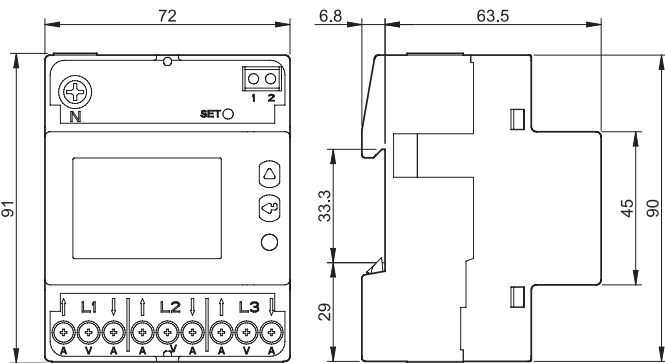

E



## Accessories



07E.13



07E.16

<b>Terminal cover</b> for type 7E.13	07E.13
--------------------------------------	--------

For the tamper-proof lead seal use two terminal covers

<b>Terminal cover</b> for type 7E.12, 7E.16 and 7E.36	07E.16
---	--------

7E.12, 7E.16 - For the tamper-proof lead seal use two terminal covers

7E.36 - For the tamper-proof lead seal use four terminal covers

## Terms and definitions

$I$	The electrical current flowing through the meter
$I_n$	The specified reference current for which the meter has been designed
$I_{st}$	The lowest declared value of " $I$ " at which the meter registers active electrical energy at unity power factor (polyphase meters with balanced load)
$I_{min}$	The values of " $I$ " above which the error lies within maximum permissible errors (MPEs) (polyphase meters with balanced load)
$I_{tr}$	The value of " $I$ " above which the error lies within the smallest MPE corresponding to the class index of the meter
$I_{max}$	The maximum value of " $I$ " for which the error lies within the MPEs

E

Detailed structure of the protocol is available on line

