

Sensor/Actuator cable - SAC-3P-M12MS/1,5-PUR/C-1L-Z - 1400786

Please be informed that the data shown in this PDF Document is generated from our Online Catalog. Please find the complete data in the user's documentation. Our General Terms of Use for Downloads are valid (<http://download.phoenixcontact.com>)



Sensor/Actuator cable, 3-position, PUR, Black RAL 9005, Plug straight M12, A-coded, on Valve connector C (8 mm), with 1 LED, connected with Z diode, Cable length: 1.5 m

As illustrated, but without SPEEDCON

Key commercial data

package_quantity	1
GTIN	4046356511599

Technical data

Dimensions

Length of cable	1.5 m
------------------------	-------

Ambient conditions

Ambient temperature (operation)	-25 °C ... 90 °C (Plug / socket)
Ambient temperature (operation)	-20 °C ... 85 °C (valve plug)
Degree of protection	IP65
Degree of protection	IP67

General

Rated current at 40°C	4 A
Rated voltage	24 V
Number of positions	3
Contact resistance	≤ 5 mΩ
Insulation resistance	≥ 100 MΩ
Coding	A - standard
Standards/regulations	M12 connector IEC 61076-2-101
Standards/regulations	Valve connector EN 175301-803
Status display	1 LED
Protective circuit/component	Z diode
Surge voltage category	III
Pollution degree	3
Insertion/withdrawal cycles	≥ 100

Material

Sensor/Actuator cable - SAC-3P-M12MS/1,5-PUR/C-1L-Z - 1400786

Technical data

Material

Inflammability class according to UL 94	HB
Contact material	CuSn
Contact surface material	Ni/Au
Contact carrier material	TPU GF
Material of grip body	TPU
Valve plug contact material	CuSn
Valve plug contact surface material	Sn
Valve plug contact insert material	PA 66
Material housing valve plug	TPU
Material, knurls	Zinc die-cast, nickel-plated
Sealing material	TPU (Seal molded)

Cable

Cable type	PUR halogen-free black
Cable type (abbreviation)	PUR
Cable abbreviation	Li9Y11Y-HF
UL AWM style	20549
Conductor cross section	3x 0.5 mm ²
AWG signal line	20
Conductor structure signal line	28x 0.15 mm
Core diameter including insulation	1.5 mm ±0.05 mm (signal line)
Wire colors	black 1, black 2, green/yellow
Overall twist	3 wires, twisted
External sheath, color	Black-gray RAL 7021
External cable diameter D	4.5 mm ± 0.2 mm
Smallest bending radius, fixed installation	22.5 mm
Number of bending cycles	15000000
Bending radius	50 mm
Traversing path	0.9 m
Traversing rate	5 m/s
Acceleration	30 m/s ²
Outer sheath, material	PUR
Material conductor insulation	PP
Conductor material	Bare Cu litz wires
Insulation resistance	min. 20 MΩ*km
Conductor resistance	39 Ω/km (at 20 °C)
Nominal voltage, cable	≤ 300 V
Test voltage, cable	≥ 1200 V
Flame resistance	According to DIN VDE 0482
Flame resistance	According to DIN EN 50265-2-1

Sensor/Actuator cable - SAC-3P-M12MS/1,5-PUR/C-1L-Z - 1400786

Technical data

Cable

Halogen-free	in accordance with DIN VDE 0472 part 815
Other resistance	Largely oil-resistant
Other resistance	partly UV-resistant in accordance with DIN EN ISO 4892-2-A
Ambient temperature (operation)	-40 °C ... 80 °C (cable, fixed installation)
Ambient temperature (operation)	-20 °C ... 80 °C (cable, flexible installation)

classifications

eCl@ss

eCl@ss 4.0	27060306
eCl@ss 4.1	27060306
eCl@ss 5.0	27061801
eCl@ss 5.1	27061801
eCl@ss 6.0	27061801
eCl@ss 7.0	27061801
eCl@ss 8.0	27061801

ETIM

ETIM 3.0	EC001855
ETIM 4.0	EC001855
ETIM 5.0	EC001855

UNSPSC

UNSPSC 6.01	31251501
UNSPSC 7.0901	31251501
UNSPSC 11	31251501
UNSPSC 12.01	31251501
UNSPSC 13.2	31251501

Drawings

Sensor/Actuator cable - SAC-3P-M12MS/1,5-PUR/C-1L-Z - 1400786

Dimensioned drawing

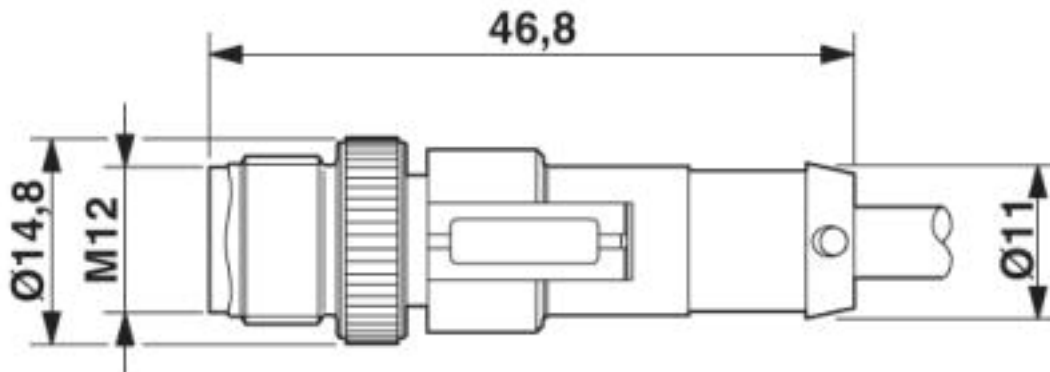

M12 x 1 plug, straight

Dimensioned drawing

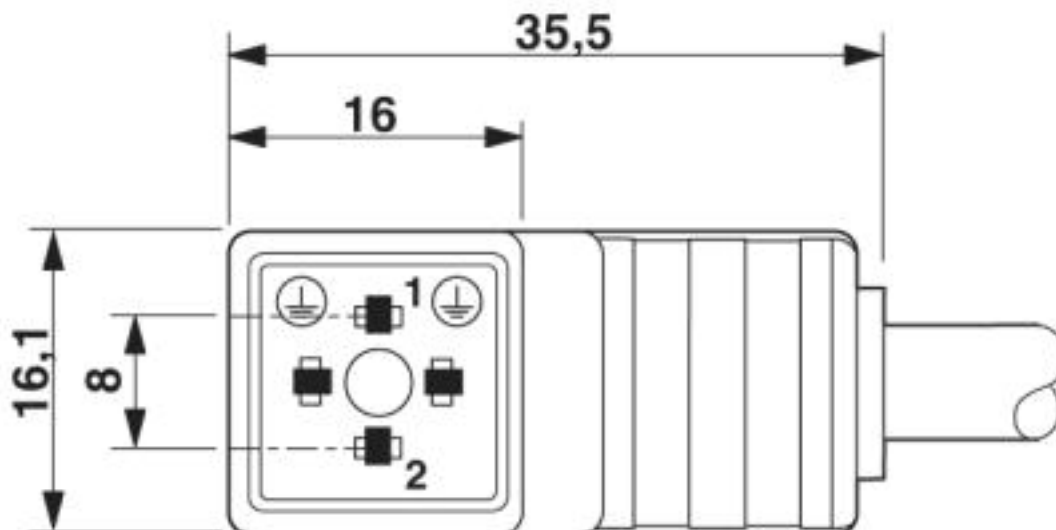

Valve connector, type C

Sensor/Actuator cable - SAC-3P-M12MS/1,5-PUR/C-1L-Z - 1400786

Dimensioned drawing

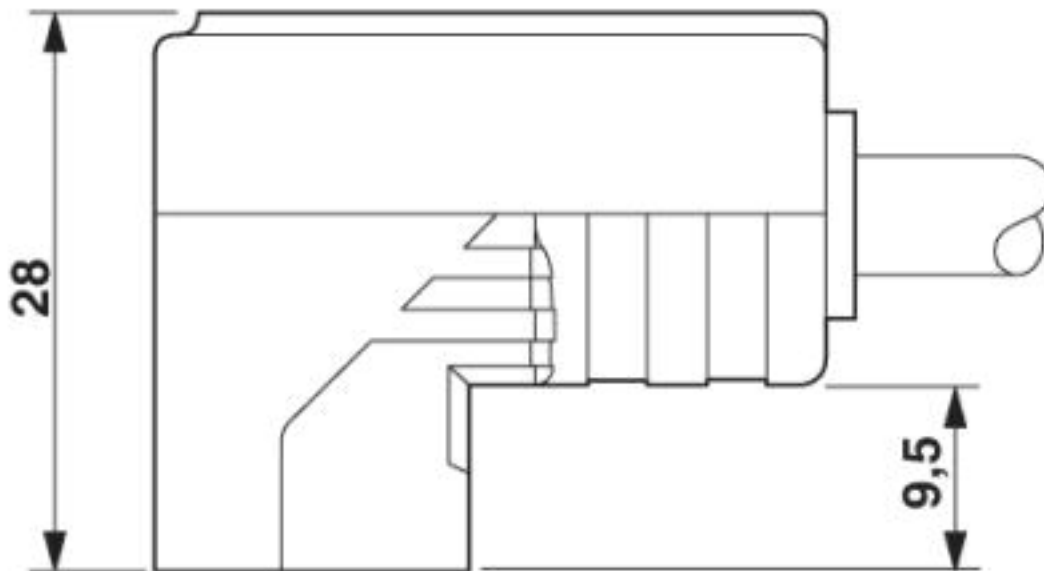

Valve connector, type C, side view

Circuit diagram

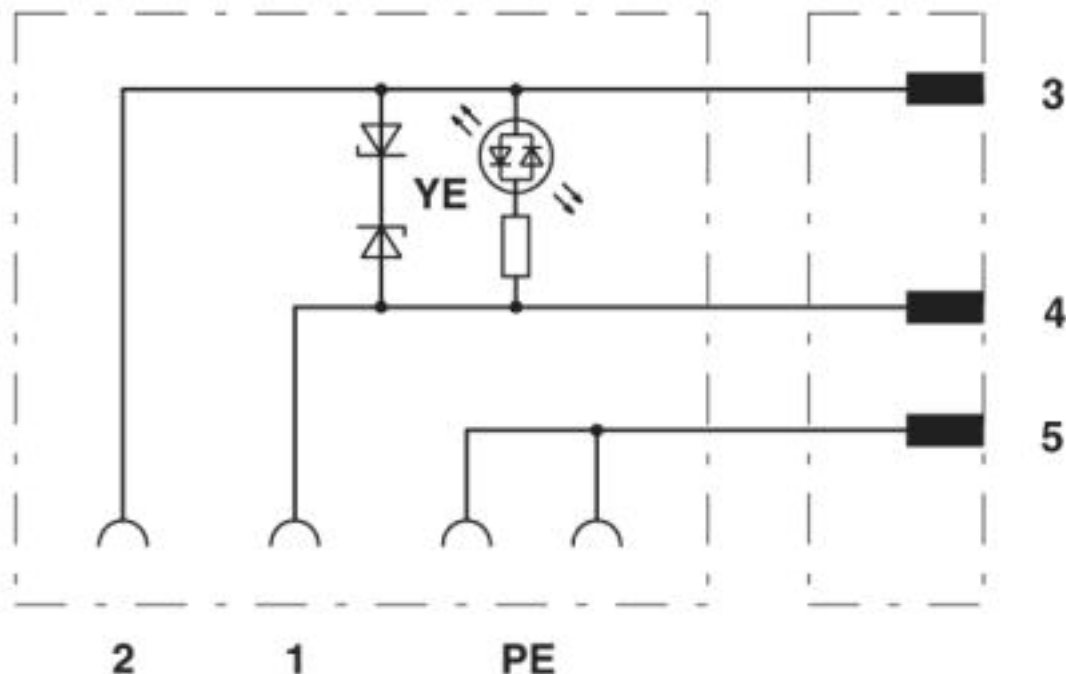

Contact assignment of M12 plug and valve connector

Sensor/Actuator cable - SAC-3P-M12MS/1,5-PUR/C-1L-Z - 1400786

Schematic diagram

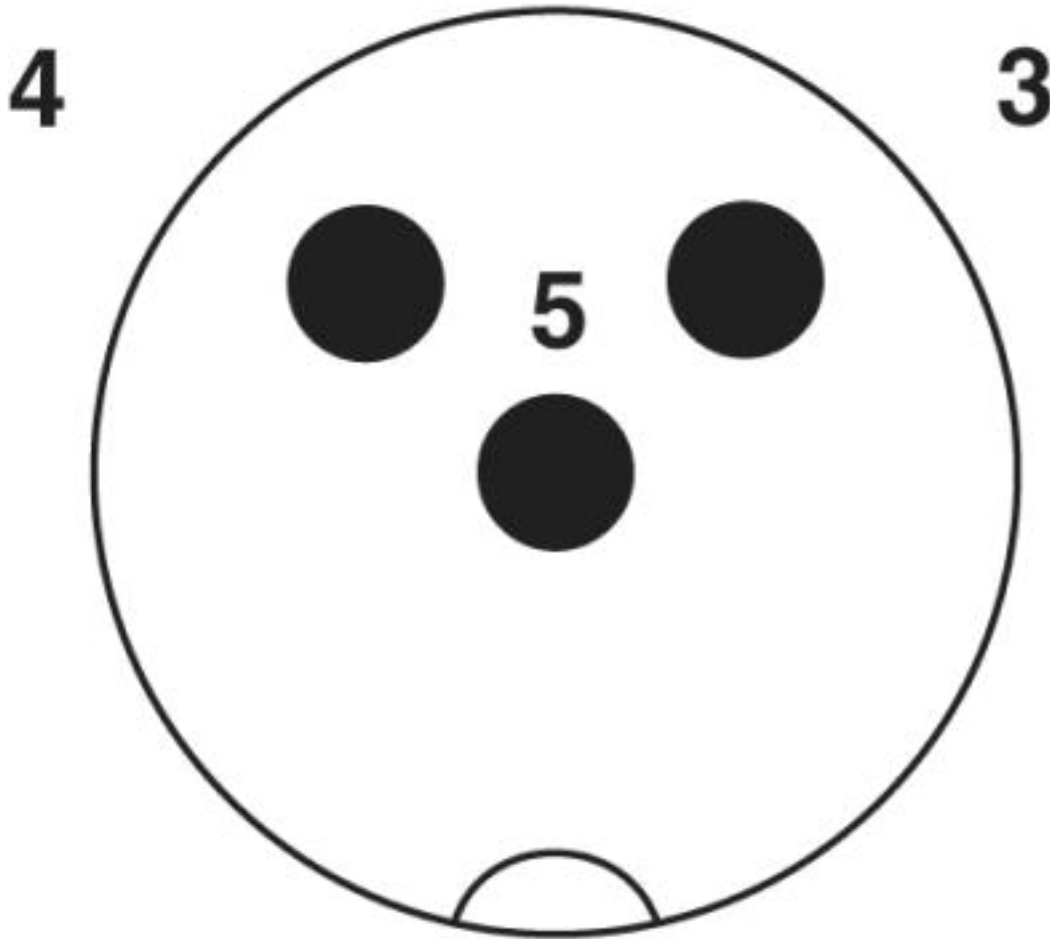

Pin assignment M12 plug, 3-pos., valve connector

Sensor/Actuator cable - SAC-3P-M12MS/1,5-PUR/C-1L-Z - 1400786

Schematic diagram

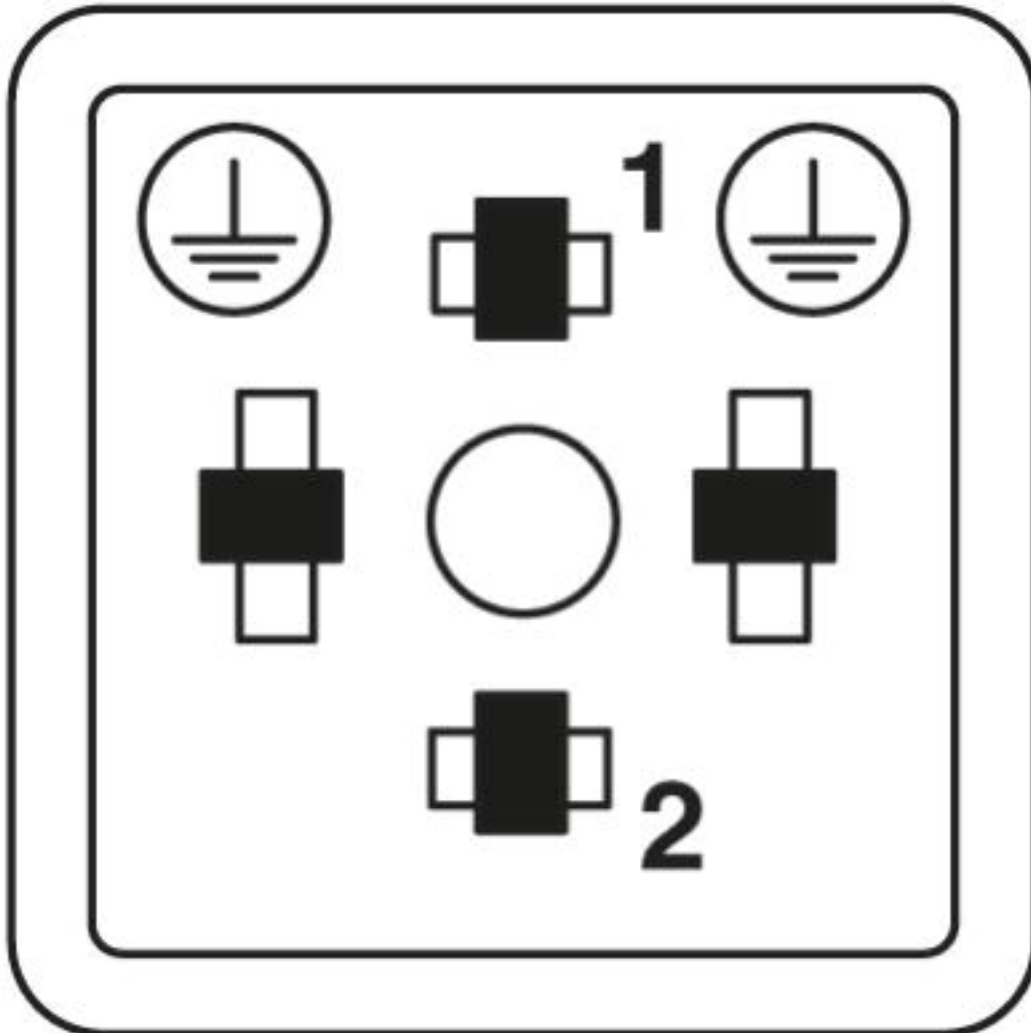

Valve connector connector pin assignment, type C

Sensor/Actuator cable - SAC-3P-M12MS/1,5-PUR/C-1L-Z - 1400786

Cable cross section

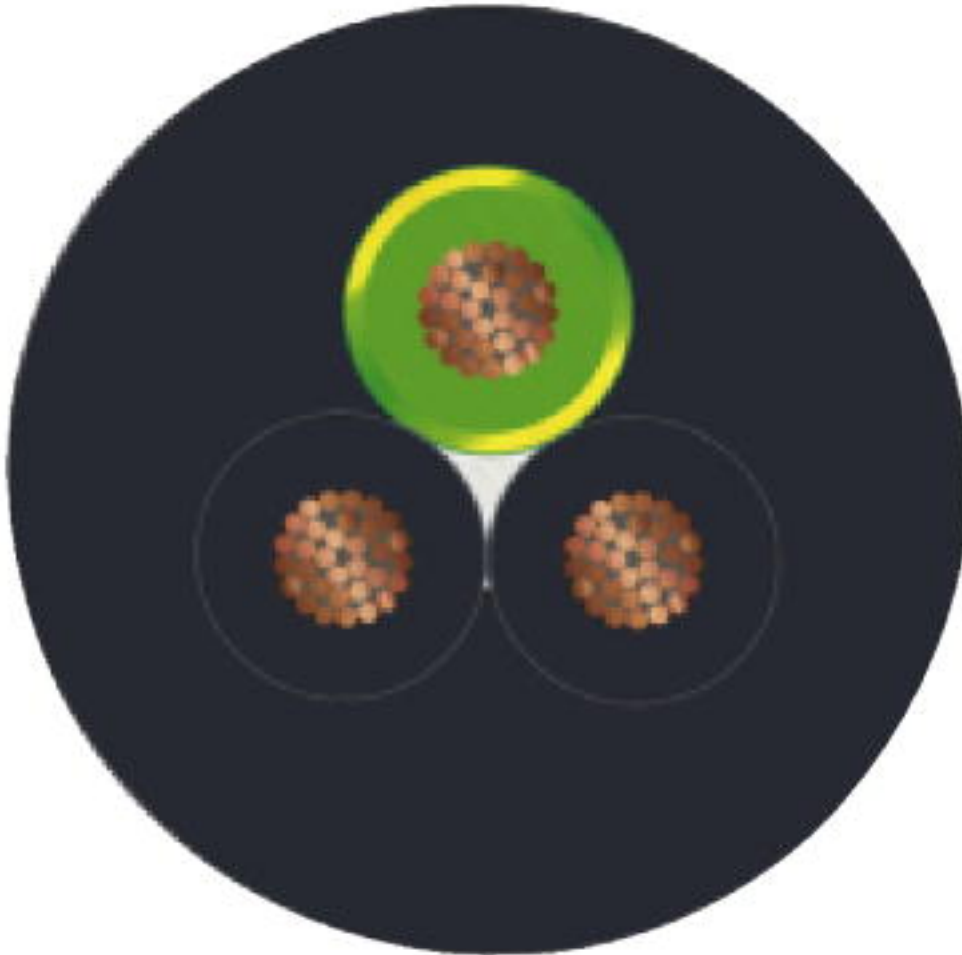

PUR halogen-free black [PUR]

© Phoenix Contact 2013 - all rights reserved
<http://www.phoenixcontact.com>