

Bus system flat-type plug - SACCEC-M12FSB-5CON-M16/5,0-900 - 1529771

Please be informed that the data shown in this PDF Document is generated from our Online Catalog. Please find the complete data in the user's documentation. Our General Terms of Use for Downloads are valid (<http://download.phoenixcontact.com>)



Bus system flush-type socket, INTERBUS, 5-pos., M12, shielded, B-coded, front/screw mounting with M16 thread, can be positioned, with 5 m bus cable, 3 x 2 x 0.25 mm²



Key commercial data

package_quantity	1
GTIN	4017918982614

Technical data

Dimensions

Length of cable	5 m
-----------------	-----

Ambient conditions

Ambient temperature (operation)	-25 °C ... 85 °C (Plug / socket)
Degree of protection	IP67

General

Rated current at 40°C	4 A
Rated voltage	60 V
Number of positions	5
Contact resistance	≤ 3 mΩ
Insulation resistance	≥ 100 MΩ
Coding	B - inverse
Standards/regulations	M12 connector IEC 61076-2-101
Status display	No
Surge voltage category	II
Pollution degree	3
Test voltage	2500 V

Material

Inflammability class according to UL 94	V0
Contact material	CuZn
Contact surface material	Ni/Au

Bus system flat-type plug - SACCEC-M12FSB-5CON-M16/5,0-900 - 1529771

Technical data

Material

Contact carrier material	PA 66
Material, knurls	Nickel-plated brass
Sealing material	NBR

Cable

Cable type	INTERBUS
Cable type (abbreviation)	900
Conductor cross section	0.22 mm ²
AWG signal line	24
Conductor structure signal line	32x 0.10 mm
Wire colors	Green-yellow, white-brown, gray-pink
Twisted pairs	2 cores to the pair
Overall twist	3 pairs to the core
Shielding	Braided copper wires
External sheath, color	Green RAL 6017
External cable diameter	8.00 mm
Smallest bending radius, fixed installation	60 mm
Smallest bending radius, movable installation	120 mm
Number of bending cycles	5000000
Bending radius	120 mm
Traversing path	10 m
Traversing rate	1.6 m/s
Acceleration	3.2 m/s ²
Outer sheath, material	PUR
Material conductor insulation	PE
Conductor material	Bare Cu litz wires
Insulation resistance	> 5 GΩ*km
Conductor resistance	≤ 159.8 mΩ/m
Working capacitance	60 nF (At 800 Hz)
Signal speed	0.66 c
Coupling resistance	250000.00 MΩ/km (At 30 MHz)
Nominal voltage, cable	250 V
Test voltage Core/Core	1500 V
Test voltage Core/Shield	1000 V
Flame resistance	IEC 60332-1
Ambient temperature (operation)	-40 °C ... 80 °C (cable, fixed installation)
Ambient temperature (operation)	-30 °C ... 70 °C (cable, flexible installation)

classifications

eCI@ss

Bus system flat-type plug - SACCEC-M12FSB-5CON-M16/5,0-900 - 1529771

classifications

eCl@ss

eCl@ss 4.0	27140815
eCl@ss 4.1	27140815
eCl@ss 5.0	27143423
eCl@ss 5.1	27143423
eCl@ss 6.0	27143423
eCl@ss 7.0	27449001
eCl@ss 8.0	27449001

ETIM

ETIM 2.0	EC001297
ETIM 3.0	EC002061
ETIM 4.0	EC002061
ETIM 5.0	EC002061

UNSPSC

UNSPSC 6.01	31251501
UNSPSC 7.0901	31251501
UNSPSC 11	31251501
UNSPSC 12.01	31251501
UNSPSC 13.2	31251501

approvals

GOST / GOST /

Approval details



Drawings

Bus system flat-type plug - SACCEC-M12FSB-5CON-M16/5,0-900 - 1529771

Dimensioned drawing

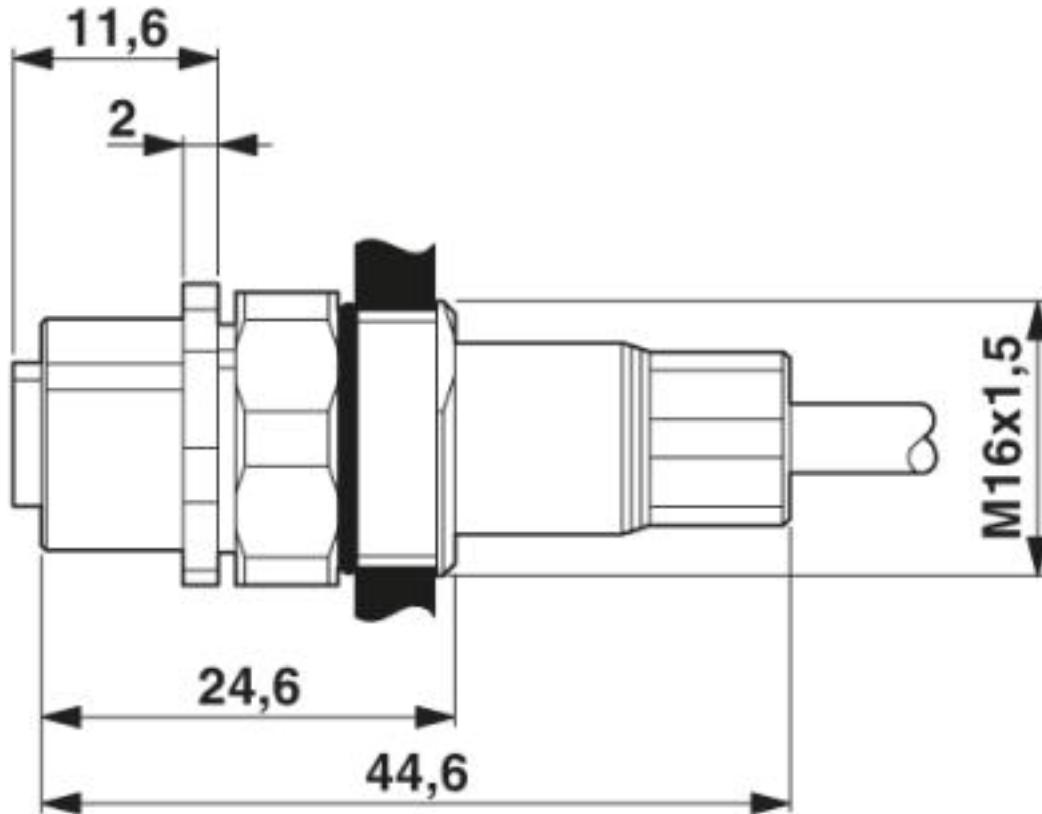

M12 flush-type connector

Bus system flat-type plug - SACCEC-M12FSB-5CON- M16/5,0-900 - 1529771

Dimensioned drawing

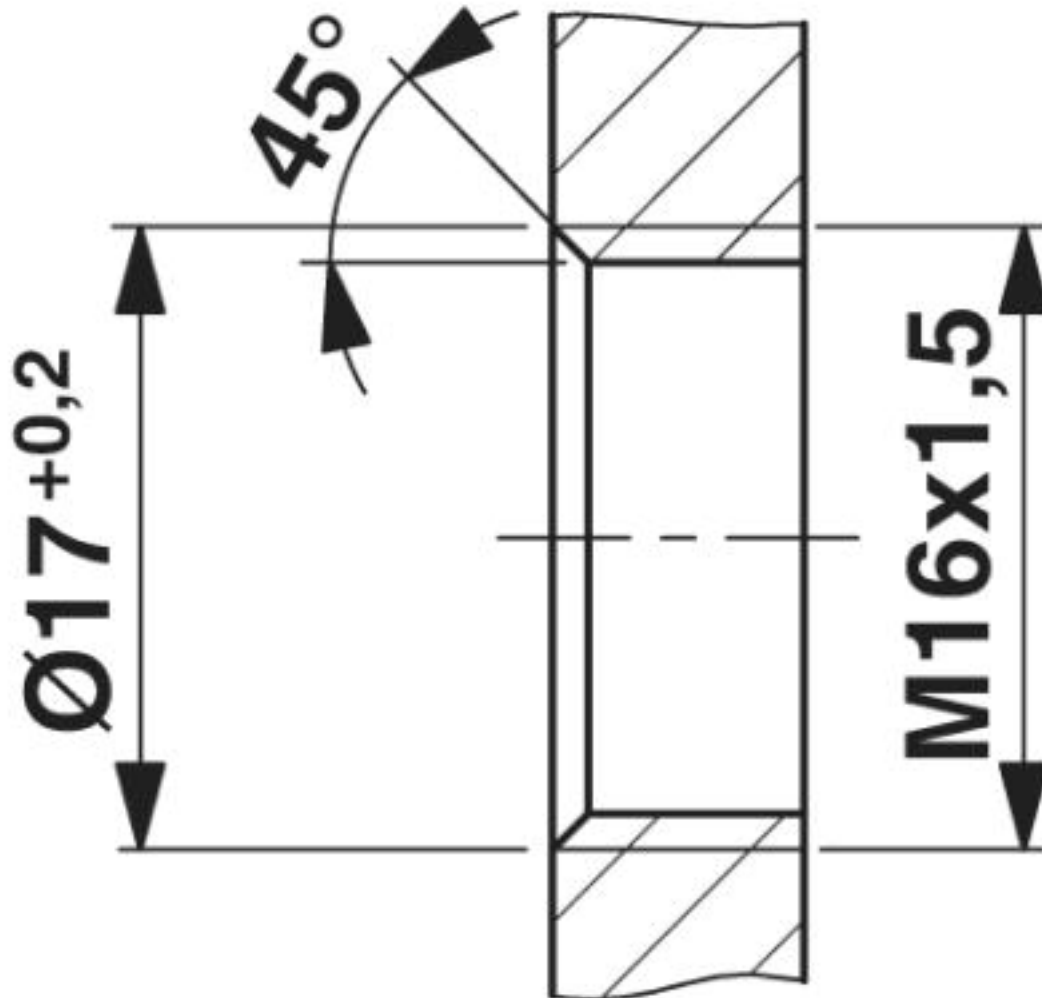

Housing cutout for M16 fastening thread, mounting panel with thread

Bus system flat-type plug - SACCEC-M12FSB-5CON-M16/5,0-900 - 1529771

Circuit diagram

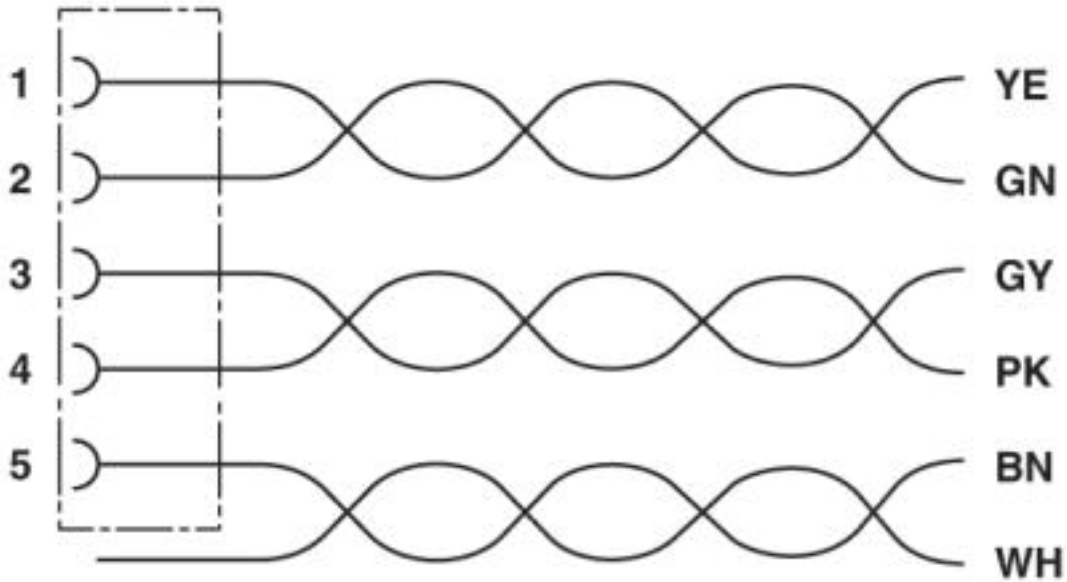

Contact assignment of the M12 socket

Bus system flat-type plug - SACCEC-M12FSB-5CON-M16/5,0-900 - 1529771

Schematic diagram

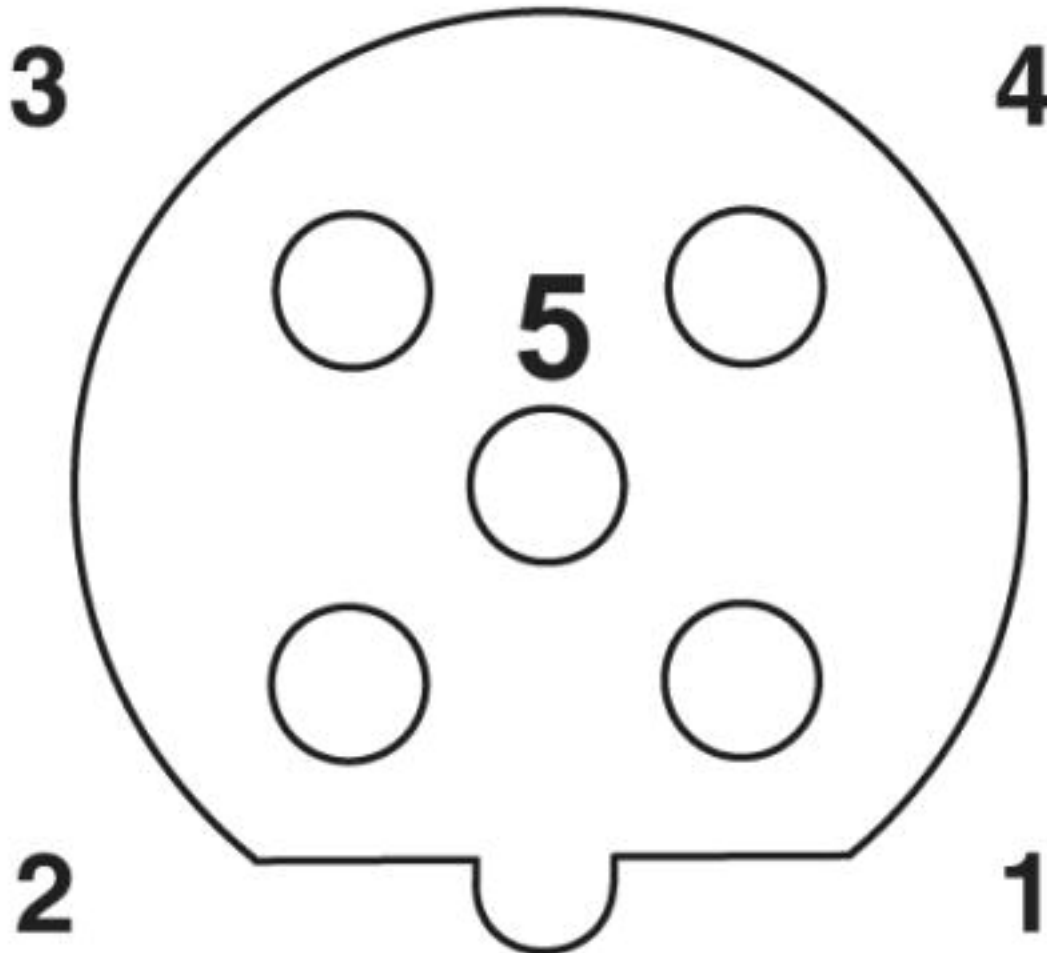

Pin assignment M12 socket, 5-pos., B-coded, female side

Bus system flat-type plug - SACCEC-M12FSB-5CON- M16/5,0-900 - 1529771

Cable cross section

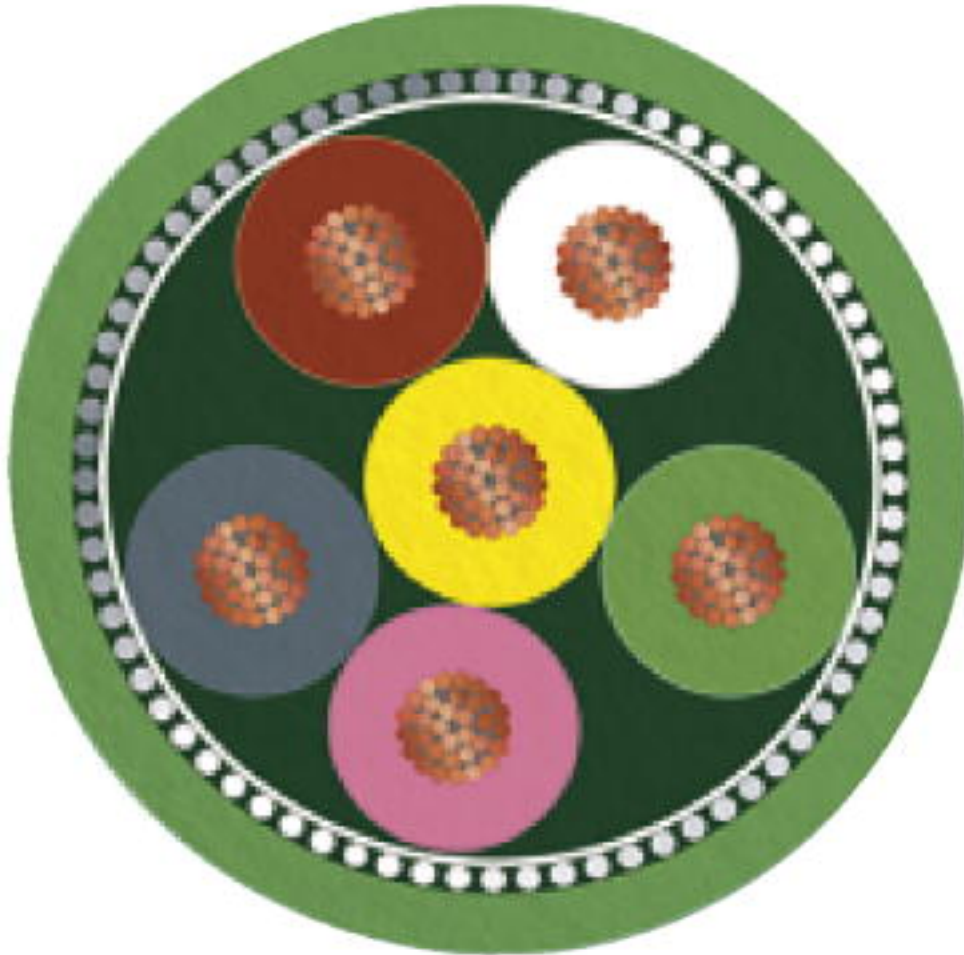

INTERBUS [900]

© Phoenix Contact 2013 - all rights reserved
<http://www.phoenixcontact.com>