

Sensor/Actuator cable - SAC-3P-10,0-170/FR-2L SCO - 1538885

Please be informed that the data shown in this PDF Document is generated from our Online Catalog. Please find the complete data in the user's documentation. Our General Terms of Use for Downloads are valid (<http://download.phoenixcontact.com>)

Sensor/Actuator cable, 3-position, PUR, Black-gray RAL 7021, Free cable end, on Socket straight M12 SPEEDCON, A-coded, with 2 LEDs, Cable length: 10 m



Key commercial data

package_quantity	1
GTIN	4046356077323

Technical data

Dimensions

Length of cable	10 m
Stripping length of the free conductor end	50 mm

Ambient conditions

Degree of protection	IP65
Degree of protection	IP67
Degree of protection	IP68

General

Rated current at 40°C	4 A
Rated voltage	250 V
Number of positions	3
Contact resistance	≤ 5 mΩ
Insulation resistance	≥ 100 MΩ
Coding	A - standard
Status display	2 LEDs
Surge voltage category	II
Pollution degree	3

Material

Inflammability class according to UL 94	HB
Contact material	CuSn
Contact surface material	Ni/Au
Contact carrier material	TPU GF

Sensor/Actuator cable - SAC-3P-10,0-170/FR-2L SCO - 1538885

Technical data

Material

Material of grip body	TPU, hardly inflammable, self-extinguishing
Material, knurls	Zinc die-cast, nickel-plated
Sealing material	NBR

Cable

Cable type	PUR halogen-free black
Cable abbreviation	Li9Y11Y
Conductor cross section	0.34 mm ²
AWG signal line	22
Conductor structure signal line	42x 0.10 mm
Core diameter including insulation	1.27 mm ±0.02 mm
Thickness, insulation	≥ 0.21 mm (Core insulation)
Thickness, insulation	≥ 0.76 mm (Outer cable sheath)
Wire colors	brown, blue, black
Overall twist	3 wires, twisted
External sheath, color	Black-gray RAL 7021
External cable diameter	4.40 mm
Smallest bending radius, movable installation	44 mm
Number of bending cycles	4000000
Bending radius	44 mm
Traversing path	10 m
Traversing rate	3 m/s
Cable weight	26 kg/km
Outer sheath, material	PUR
Material conductor insulation	PP
Conductor material	Bare Cu litz wires
Insulation resistance	≥ 100 GΩ*km
Conductor resistance	≤ 58 Ω/m
Nominal voltage, cable	300 V
Test voltage, cable	3000 V

classifications

eCl@ss

eCl@ss 4.0	27060306
eCl@ss 4.1	27060306
eCl@ss 5.0	27061801
eCl@ss 5.1	27061801
eCl@ss 6.0	27061801
eCl@ss 7.0	27061801
eCl@ss 8.0	27061801

ETIM

Sensor/Actuator cable - SAC-3P-10,0-170/FR-2L SCO - 1538885

classifications

ETIM

ETIM 2.0	EC000830
ETIM 3.0	EC001855
ETIM 4.0	EC001855
ETIM 5.0	EC001855

UNSPSC

UNSPSC 6.01	31251501
UNSPSC 7.0901	31251501
UNSPSC 11	31251501
UNSPSC 12.01	31251501
UNSPSC 13.2	31251501

approvals

UL Listed / cUL Listed / cULus Listed /

Approval details

UL Listed 	
Nominal voltage UN	24 V
Nominal current IN	4 A
mm ² /AWG/kcmil	

cUL Listed 	
Nominal voltage UN	24 V
Nominal current IN	4 A
mm ² /AWG/kcmil	

cULus Listed 	
---	--

Drawings

Sensor/Actuator cable - SAC-3P-10,0-170/FR-2L SCO - 1538885

Dimensioned drawing

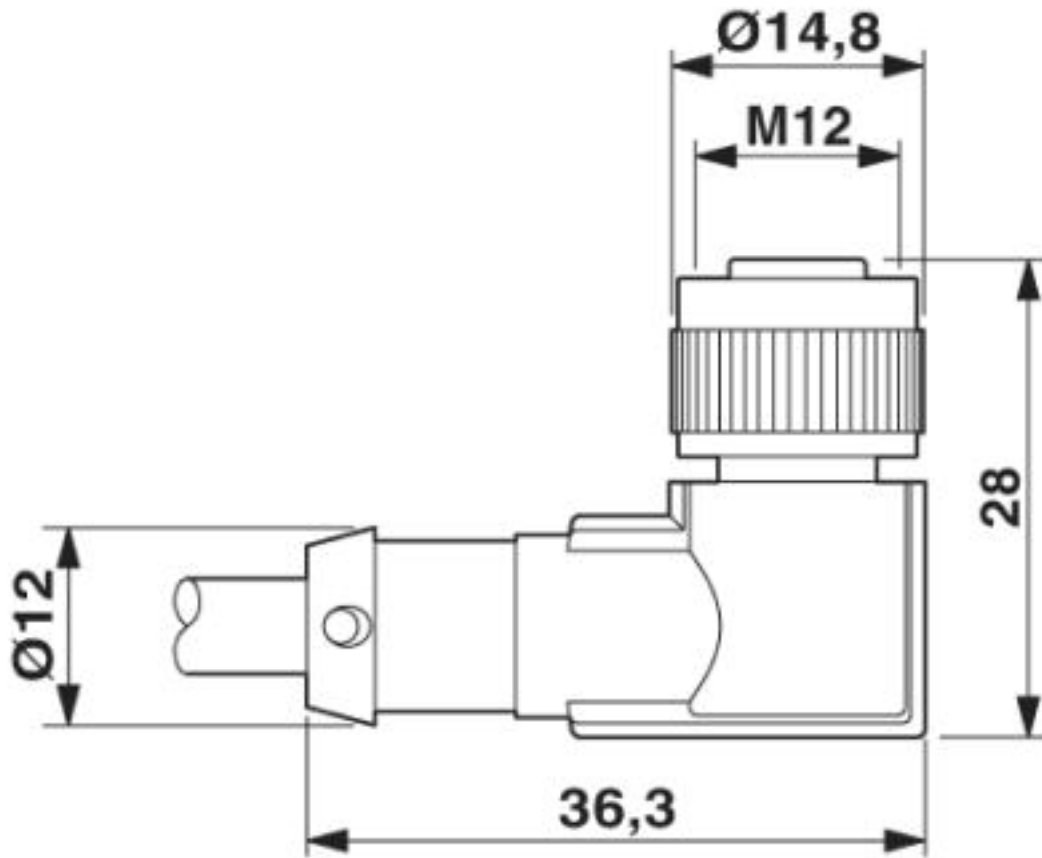

Socket M12 x 1, angled, with LED

Sensor/Actuator cable - SAC-3P-10,0-170/FR-2L SCO - 1538885

Circuit diagram

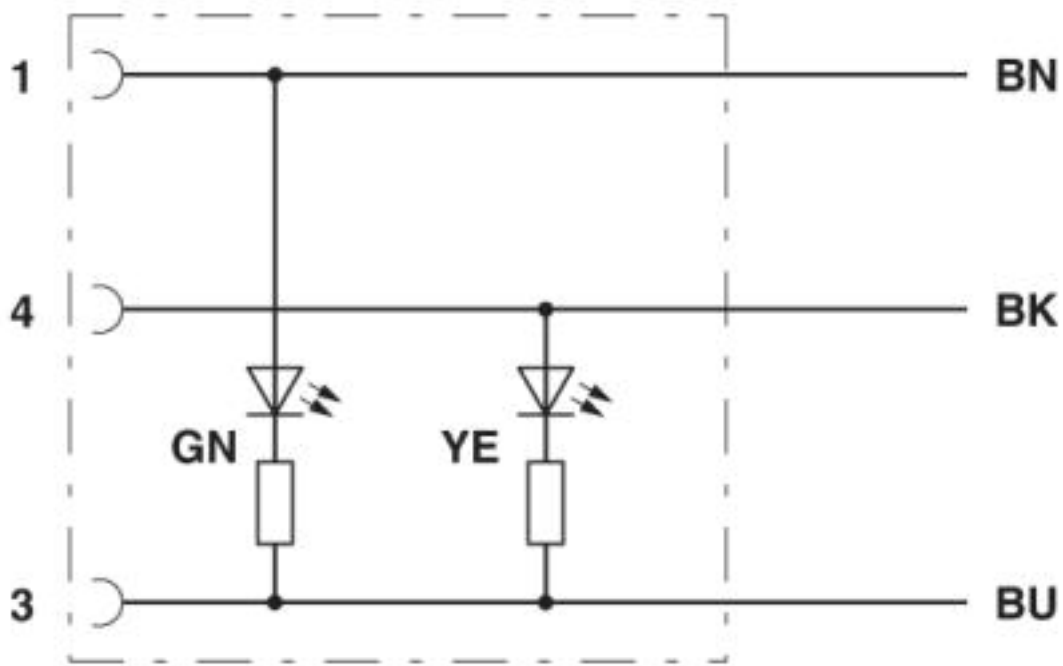

Contact assignment of the M12 plug and the M12 socket

Sensor/Actuator cable - SAC-3P-10,0-170/FR-2L SCO - 1538885

Schematic diagram

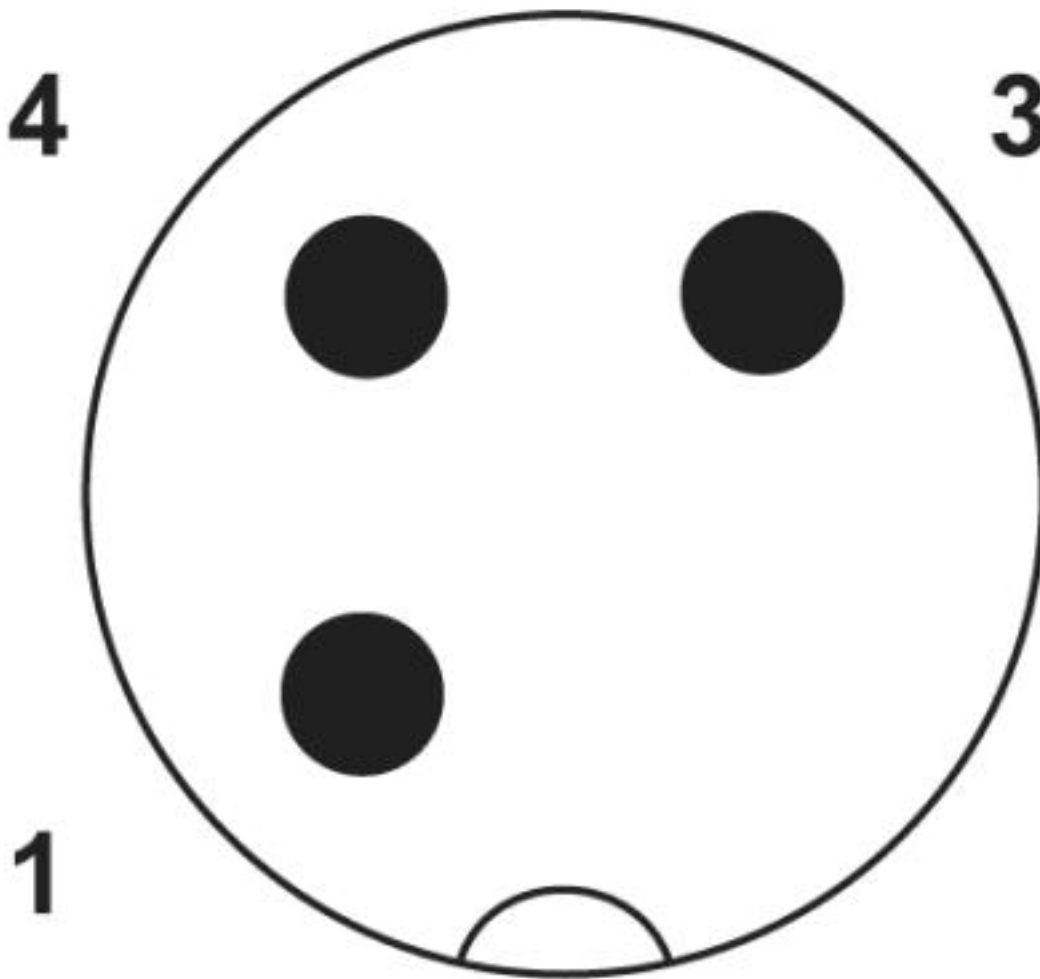

Pin assignment M12 plug, 3-pos., A-coded, view male side

Sensor/Actuator cable - SAC-3P-10,0-170/FR-2L SCO - 1538885

Schematic diagram

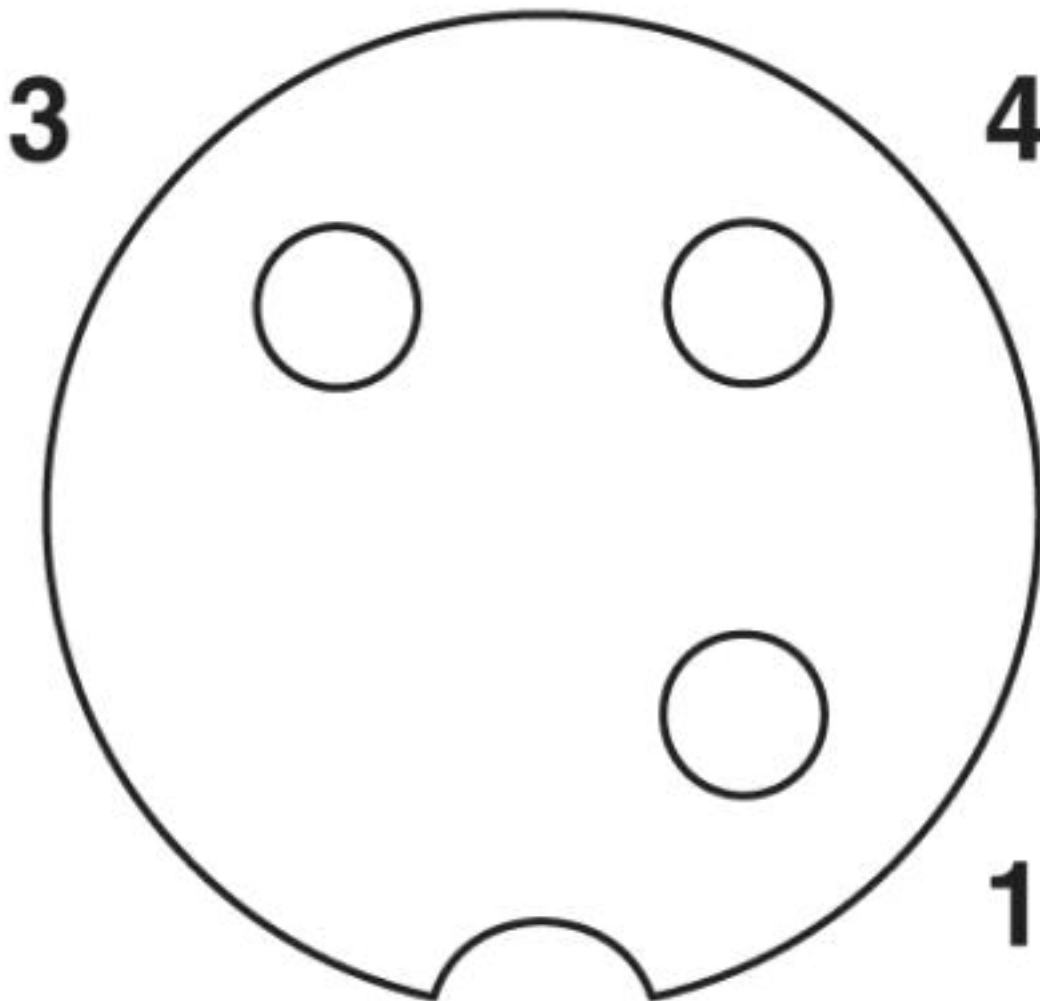

Pin assignment M12 socket, 3-pos., A-coded, view female side

Sensor/Actuator cable - SAC-3P-10,0-170/FR-2L SCO - 1538885

Cable cross section

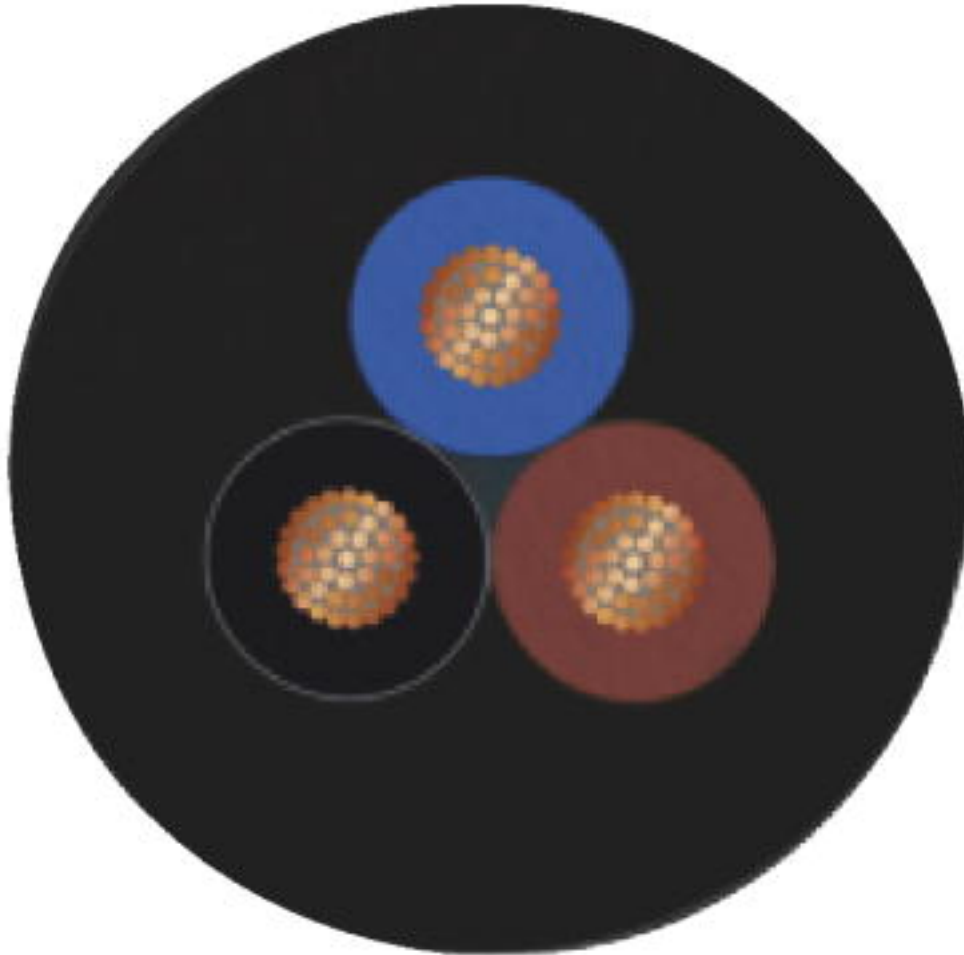

PUR halogen-free black [PUR]

© Phoenix Contact 2013 - all rights reserved
<http://www.phoenixcontact.com>