

SEMICONDUCTOR RELAY 3RF2, 1-PH. WIDTH 45 MM, 50 A 48-460 V / 4-30 V DC SCREW CONNECTION



General technical data:

product brand name		SIRIUS
Product designation		solid-state relay
Product function		zero-point switching
Number of poles for main current circuit		1
Protection class IP		IP20
Ambient temperature		
• during operation	°C	-25 ... +60
• during storage	°C	-55 ... +80
Installation altitude at height above sea level maximum	m	1 000
Vibration resistance acc. to IEC 60068-2-6		2g
Shock resistance acc. to IEC 60068-2-27		15g / 11 ms
Equipment marking acc. to DIN 40719 extended according to IEC 204-2 acc. to IEC 750		K
Equipment marking acc. to DIN EN 61346-2		Q
Number of NC contacts for auxiliary contacts		0
Number of NO contacts for auxiliary contacts		0
Number of CO contacts for auxiliary contacts		0

**Main circuit:**

<b>Number of NO contacts for main contacts</b>		1
<b>Number of NC contacts for main contacts</b>		0
<b>Operating current</b>		
• Rated value maximum	A	50
• at AC-51 Rated value	A	50
• minimum	mA	500
<b>Operating voltage at AC</b>		
• at 50 Hz Rated value	V	48 ... 460
• at 60 Hz Rated value	V	48 ... 460
<b>Operating range relative to the operating voltage at AC</b>		
• at 50 Hz	V	40 ... 506
• at 60 Hz	V	40 ... 506
<b>Operating frequency Rated value</b>	Hz	50 ... 60
<b>Relative symmetrical tolerance of the operating frequency</b>	%	10
<b>Insulation voltage Rated value</b>	V	600
<b>Rate of voltage rise at the thyristor for main contacts maximum permissible</b>	V/μs	1 000
<b>Blocking voltage at the thyristor for main contacts maximum permissible</b>	V	1 200
<b>Reverse current of the thyristor</b>	mA	10
<b>Derating temperature</b>	°C	40
<b>Active power loss total typical</b>	W	66
<b>Surge current resistance Rated value</b>	A	600
<b>I<sup>2</sup>t value maximum</b>	A <sup>2</sup> ·s	1 800
<b>Short-circuit protection, design of the fuse link</b>		

**Control circuit/ Control:**

<b>Type of voltage of the control supply voltage</b>		DC
<b>Control supply voltage 1</b>		
• at DC		
— Initial rated value	V	4
— Final rated value	V	30
<b>Control supply voltage</b>		
• at DC Full-scale value for signal<0> recognition	V	1
<b>Relative symmetrical tolerance of the supply voltage frequency</b>	%	10
<b>Control current</b>		
• at minimum control supply voltage		
— at DC	mA	3
• at DC Rated value	mA	15

**Installation/ mounting/ dimensions:**





<b>Mounting type</b>		screw fixing
<b>Mounting type Side-by-side mounting</b>		Yes
<b>Design of the thread of the screw for securing the equipment</b>		M4
<b>Tightening torque of the screw for securing the equipment</b>	N·m	1.5
<b>Width</b>	mm	45
<b>Height</b>	mm	58
<b>Depth</b>	mm	48

**Connections/ Terminals:**

<b>Type of electrical connection for main current circuit</b>		screw-type terminals
<b>Design of the thread of the connection screw for main contacts</b>		M4
<b>Tightening torque for main contacts with screw-type terminals</b>		
• minimum	N·m	2
• maximum	N·m	2.5
<b>Tightening torque [lbf·in] for main contacts with screw-type terminals</b>		
• minimum	lbf·in	7
• maximum	lbf·in	10.3
<b>Type of connectable conductor cross-section</b>		
• for main contacts		
— solid		2x (1.5 ... 2.5 mm <sup>2</sup> ), 2x (2.5 ... 6 mm <sup>2</sup> )
— finely stranded		
— with core end processing		2x (1 ... 2.5 mm <sup>2</sup> ), 2x (2.5 ... 6 mm <sup>2</sup> ), 1x 10 mm <sup>2</sup>
• for AWG conductors		
— for main contacts		2x (14 ... 10)
— for auxiliary and control contacts		1x (AWG 20 ... 12)
• for auxiliary and control contacts		
— solid		1x (0.5 ... 2.5 mm <sup>2</sup> ), 2x (0.5 ... 1.0 mm <sup>2</sup> )
— finely stranded		
— with core end processing		1x (0.5 ... 2.5 mm <sup>2</sup> ), 2x (0.5 ... 1.0 mm <sup>2</sup> )
— without core end processing		1x (0.5 ... 2.5 mm <sup>2</sup> ), 2x (0.5 ... 1.0 mm <sup>2</sup> )
<b>Connectable conductor cross-section</b>		
• for main contacts		
— single or multi-stranded	mm <sup>2</sup>	1.5 ... 6
— finely stranded		
— with core end processing	mm <sup>2</sup>	1 ... 10
• for auxiliary and control contacts		
— solid	mm <sup>2</sup>	0.5 ... 2.5

— finely stranded		
— with core end processing	mm <sup>2</sup>	0.5 ... 2.5
— without core end processing	mm <sup>2</sup>	0.5 ... 2.5
<b>AWG number as coded connectable conductor cross section</b>		
• for main contacts		14 ... 10
• for auxiliary and control contacts		20 ... 12
<b>Type of electrical connection for auxiliary and control current circuit</b>		screw-type terminals
<b>Design of the thread of the connection screw of the auxiliary and control contacts</b>		M3
<b>Wire stripping length of the cable</b>		
• for main contacts	mm	10
• for auxiliary and control contacts	mm	7
<b>Tightening torque for auxiliary and control contacts with screw-type terminals</b>	N·m	0.5 ... 0.6
<b>Tightening torque [lbf·in] for auxiliary and control contacts with screw-type terminals</b>	lbf·in	4.5 ... 5.3

#### Certificates/ approvals:

General Product Approval	EMC	Declaration of Conformity	Test Certificates
 CSA	 UR		 C-TICK
		 EG-Konf.	<a href="#">Typprüfbescheinigung/Werkszeugnis</a>

#### other

[Umweltbestätigung](#)

#### Further information

##### Short-circuit protection, design of the fuse link

[https://www.automation.siemens.com/cd-static/material/info/3RF20\\_eng.pdf](https://www.automation.siemens.com/cd-static/material/info/3RF20_eng.pdf)

##### Information- and Downloadcenter (Catalogs, Brochures,...)

<http://www.siemens.com/industrial-controls/catalogs>

##### Industry Mall (Online ordering system)

<http://www.siemens.com/industrymall>

##### Cax online generator

<http://support.automation.siemens.com/WW/CAXorder/default.aspx?lang=en&mlfb=3RF20501AA44>

##### Service&Support (Manuals, Certificates, Characteristics, FAQs,...)

<https://support.industry.siemens.com/cs/ww/en/ps/3RF20501AA44>

##### Image database (product images, 2D dimension drawings, 3D models, device circuit diagrams, EPLAN macros, ...)

[http://www.automation.siemens.com/bilddb/cax\\_de.aspx?mlfb=3RF20501AA44&lang=en](http://www.automation.siemens.com/bilddb/cax_de.aspx?mlfb=3RF20501AA44&lang=en)

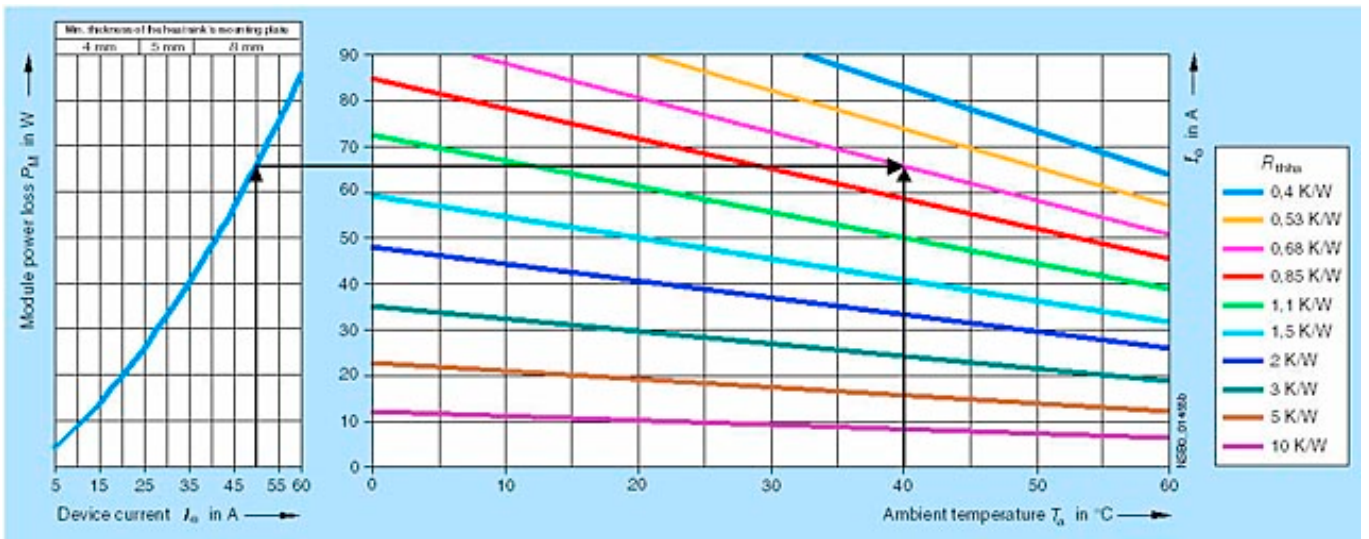
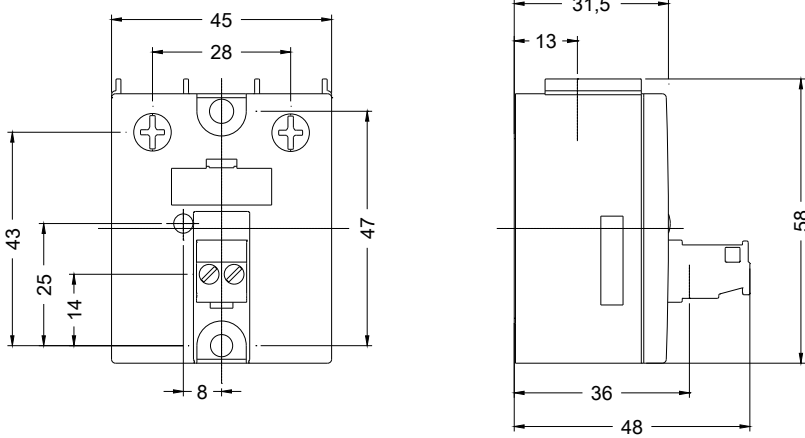

last modified:

17.07.2015