

SEMI-COND. CONTACTOR 3RF2,1-PH. AC51 30A 40 DEG. C 24-230 V / 24 V DC LOW NOISE



General technical data:

product brand name	SIRIUS
Product designation	solid-state contactor
Product function	low noise
Number of poles for main current circuit	1
Protection class IP	IP20
Product designation _1 of the accessories that can be ordered	terminal cover
Manufacturer article number _1 of the accessories that can be ordered	<a href="#">3RF2900-3PA88</a>
Product designation _3 of the accessories that can be ordered	converter
Manufacturer article number _3 of the accessories that can be ordered	<a href="#">3RF2900-0EA18</a>
Product designation _4 of the accessories that can be ordered	load monitoring
Manufacturer article number _4 of the accessories that can be ordered	<a href="#">3RF2950-0GA13</a>
Product designation _5 of the accessories that can be ordered	load monitoring, basis

Manufacturer article number _5 of the accessories that can be ordered		<a href="#">3RF2920-0FA08</a>
Ambient temperature		
• during operation	°C	-25 ... +60
• during storage	°C	-55 ... +80
Installation altitude at height above sea level maximum	m	1 000
Vibration resistance acc. to IEC 60068-2-6		2g
Shock resistance acc. to IEC 60068-2-27		15g / 11 ms
Equipment marking acc. to DIN 40719 extended according to IEC 204-2 acc. to IEC 750		K
Equipment marking acc. to DIN EN 61346-2		Q
Number of NC contacts for auxiliary contacts		0
Number of NO contacts for auxiliary contacts		0
Number of CO contacts for auxiliary contacts		0

#### Main circuit:

Number of NO contacts for main contacts		1
Number of NC contacts for main contacts		0
Operating current		
• at AC-51 Rated value	A	30
Operating current minimum	mA	500
Operating voltage at AC		
• at 50 Hz Rated value	V	24 ... 230
• at 60 Hz Rated value	V	24 ... 230
Operating range relative to the operating voltage at AC		
• at 50 Hz	V	20 ... 253
• at 60 Hz	V	20 ... 253
Operating frequency Rated value	Hz	50 ... 60
Insulation voltage Rated value	V	600
Rate of voltage rise at the thyristor for main contacts maximum permissible	V/μs	1 000
Blocking voltage at the thyristor for main contacts maximum permissible	V	800
Reverse current of the thyristor	mA	25
Derating temperature	°C	40
Active power loss total typical	W	33
Surge current resistance Rated value	A	600
I <sup>2</sup> t value maximum	A <sup>2</sup> ·s	1 800

#### Control circuit/ Control:

Type of voltage of the control supply voltage		DC
Control supply voltage 1		
• at DC		

— Initial rated value	V	15
— Final rated value	V	24
<b>Control supply voltage</b>		
• at DC Full-scale value for signal<0> recognition	V	5
<b>Control current</b>		
• at minimum control supply voltage		
— at DC	mA	2
• at DC Rated value	mA	15

#### Installation/ mounting/ dimensions:





<b>Mounting type</b>		screw and snap-on mounting onto 35 mm standard mounting rail
<b>Mounting type Side-by-side mounting</b>		Yes
<b>Design of the thread of the screw for securing the equipment</b>		M4
<b>Tightening torque of the screw for securing the equipment</b>	N·m	1.5
<b>Width</b>	mm	45
<b>Height</b>	mm	100
<b>Depth</b>	mm	156

#### Connections/ Terminals:

<b>Type of electrical connection for main current circuit</b>		screw-type terminals
<b>Design of the thread of the connection screw for main contacts</b>		M4
<b>Tightening torque for main contacts with screw-type terminals</b>	N·m	2 ... 2.5
<b>Tightening torque [lbf·in] for main contacts with screw-type terminals</b>	lbf·in	18 ... 22
<b>Type of connectable conductor cross-section for main contacts</b>		
• solid		2x (1.5 ... 2.5 mm <sup>2</sup> ), 2x (2.5 ... 6 mm <sup>2</sup> )
• finely stranded		
— with core end processing		2x (1 ... 2.5 mm <sup>2</sup> ), 2x (2.5 ... 6 mm <sup>2</sup> ), 1x 10 mm <sup>2</sup>
<b>Type of connectable conductor cross-section</b>		
• for AWG conductors		
— for main contacts		2x (14 ... 10)
— for auxiliary and control contacts		1x (AWG 20 ... 12)
<b>Type of connectable conductor cross-section for auxiliary and control contacts</b>		
• solid		1x (0.5 ... 2.5 mm <sup>2</sup> ), 2x (0.5 ... 1.0 mm <sup>2</sup> )
• finely stranded		
— with core end processing		1x (0.5 ... 2.5 mm <sup>2</sup> ), 2x (0.5 ... 1.0 mm <sup>2</sup> )
— without core end processing		1x (0.5 ... 2.5 mm <sup>2</sup> ), 2x (0.5 ... 1.0 mm <sup>2</sup> )
<b>Connectable conductor cross-section</b>		

<ul style="list-style-type: none"> <li>• for main contacts <ul style="list-style-type: none"> <li>— single or multi-stranded</li> </ul> </li> <li>— finely stranded <ul style="list-style-type: none"> <li>— with core end processing</li> </ul> </li> </ul>	mm <sup>2</sup>	1.5 ... 6
<ul style="list-style-type: none"> <li>• for auxiliary and control contacts <ul style="list-style-type: none"> <li>— solid</li> </ul> </li> <li>— finely stranded <ul style="list-style-type: none"> <li>— with core end processing</li> <li>— without core end processing</li> </ul> </li> </ul>	mm <sup>2</sup>	1 ... 10
<ul style="list-style-type: none"> <li>• for auxiliary and control contacts <ul style="list-style-type: none"> <li>— solid</li> </ul> </li> <li>— finely stranded <ul style="list-style-type: none"> <li>— with core end processing</li> <li>— without core end processing</li> </ul> </li> </ul>	mm <sup>2</sup>	0.5 ... 2.5
<ul style="list-style-type: none"> <li>• for auxiliary and control contacts <ul style="list-style-type: none"> <li>— without core end processing</li> </ul> </li> </ul>	mm <sup>2</sup>	0.5 ... 2.5
<b>AWG number as coded connectable conductor cross section</b>		
<ul style="list-style-type: none"> <li>• for main contacts</li> </ul>		10 ... 14
<ul style="list-style-type: none"> <li>• for auxiliary and control contacts</li> </ul>		20 ... 12
<b>Type of electrical connection for auxiliary and control current circuit</b>		screw-type terminals
<b>Design of the thread of the connection screw of the auxiliary and control contacts</b>		M3
<b>Wire stripping length of the cable</b>		
<ul style="list-style-type: none"> <li>• for main contacts</li> </ul>	mm	7
<ul style="list-style-type: none"> <li>• for auxiliary and control contacts</li> </ul>	mm	7
<b>Tightening torque for auxiliary and control contacts with screw-type terminals</b>	N·m	0.5 ... 0.6
<b>Tightening torque [lbf·in] for auxiliary and control contacts with screw-type terminals</b>	lbf·in	4.5 ... 5.3

#### Certificates/ approvals:

General Product Approval	EMC	Declaration of Conformity	Test Certificates
 CSA	 UL		 C-TICK
		 EG-Konf.	<a href="#">spezielle Prüfbescheinigung</a> n

Test Certificates	other
<a href="#">Typprüfbescheinigung/Werkszeugnis</a>	<a href="#">Umweltbestätigung</a>

#### Further information

**Short-circuit protection, design of the fuse link**

[https://www.automation.siemens.com/cd-static/material/info/3RF23\\_eng.pdf](https://www.automation.siemens.com/cd-static/material/info/3RF23_eng.pdf)

**Information- and Downloadcenter (Catalogs, Brochures,...)**

<http://www.siemens.com/industrial-controls/catalogs>

**Industry Mall (Online ordering system)**

<http://www.siemens.com/industrymall>

**Cax online generator**

<http://support.automation.siemens.com/WW/CAXorder/default.aspx?lang=en&mfb=3RF23301CA02>

**Service&Support (Manuals, Certificates, Characteristics, FAQs,...)**

<https://support.industry.siemens.com/cs/ww/en/ps/3RF23301CA02>

**Image database (product images, 2D dimension drawings, 3D models, device circuit diagrams, EPLAN macros, ...)**

[http://www.automation.siemens.com/bilddb/cax\\_de.aspx?mfb=3RF23301CA02&lang=en](http://www.automation.siemens.com/bilddb/cax_de.aspx?mfb=3RF23301CA02&lang=en)

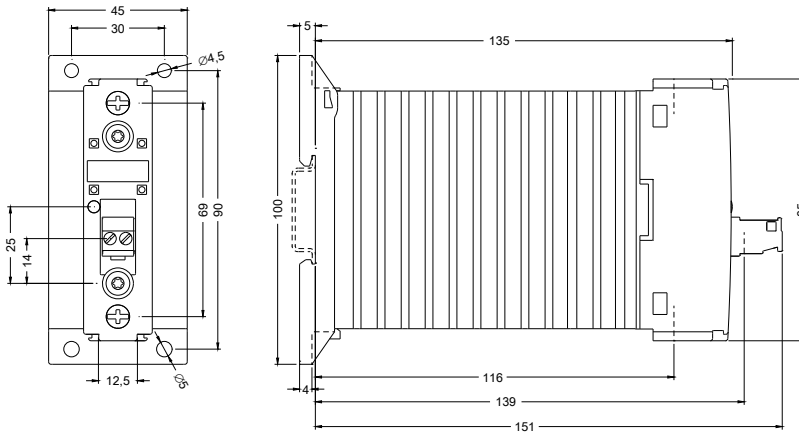

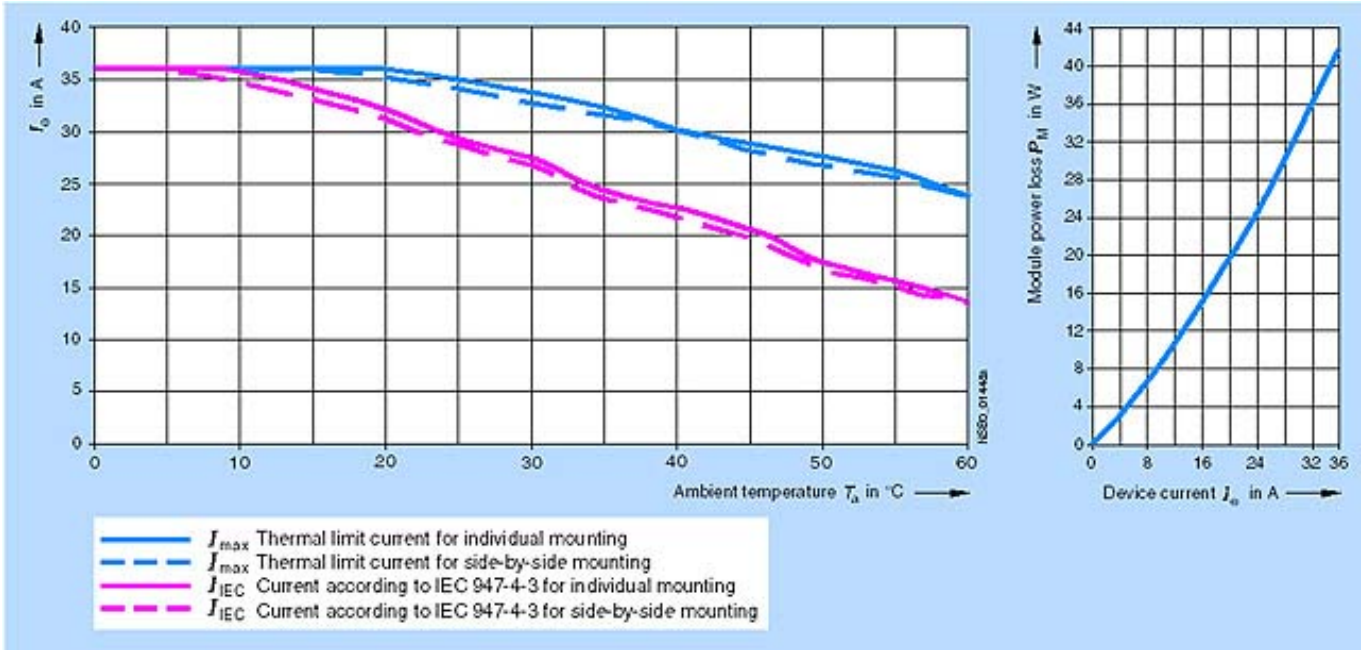

last modified:

17.07.2015