

SEMI-COND. CONTACTOR 3RF2, 1-PH AC 51 10 A
40 DEGREES C 24-230 V / 24 V DC SPRING-LOADED
TERMINAL



Figure similar

General technical data:		
product brand name		SIRIUS
Product designation		solid-state contactor
Product function		zero-point switching
Number of poles for main current circuit		1
Protection class IP		IP20
Product designation _3 of the accessories that can be ordered		converter
Manufacturer article number _3 of the accessories that can be ordered		3RF2900-0EA18
Ambient temperature		
• during operation	°C	-25 ... +60
• during storage	°C	-55 ... +80
Installation altitude at height above sea level maximum	m	1 000
Vibration resistance acc. to IEC 60068-2-6		2g
Shock resistance acc. to IEC 60068-2-27		15g / 11 ms
Equipment marking acc. to DIN 40719 extended according to IEC 204-2 acc. to IEC 750		K
Equipment marking acc. to DIN EN 61346-2		Q

Number of NC contacts for auxiliary contacts		0
Number of NO contacts for auxiliary contacts		0
Number of CO contacts for auxiliary contacts		0

Main circuit:

Number of NO contacts for main contacts		1
Number of NC contacts for main contacts		0
Operating current		
• at AC-51 Rated value	A	10.5
Operating current minimum	mA	100
Operating voltage at AC		
• at 50 Hz Rated value	V	24 ... 230
• at 60 Hz Rated value	V	24 ... 230
Operating range relative to the operating voltage at AC		
• at 50 Hz	V	20 ... 253
• at 60 Hz	V	20 ... 253
Operating frequency Rated value	Hz	50 ... 60
Insulation voltage Rated value	V	600
Rate of voltage rise at the thyristor for main contacts maximum permissible	V/ μ s	500
Blocking voltage at the thyristor for main contacts maximum permissible	V	800
Reverse current of the thyristor	mA	10
Derating temperature	$^{\circ}$ C	40
Active power loss total typical	W	11
Surge current resistance Rated value	A	200
I ² t value maximum	A ² ·s	200

Control circuit/ Control:

Type of voltage of the control supply voltage		DC
Control supply voltage 1		
• at DC		
— Initial rated value	V	15
— Final rated value	V	24
Control supply voltage		
• at DC Full-scale value for signal<0> recognition	V	5
Control current		
• at minimum control supply voltage		
— at DC	mA	2
• at DC Rated value	mA	15

Installation/ mounting/ dimensions:

Mounting type		screw and snap-on mounting onto 35 mm standard mounting rail
---------------	--	--

Mounting type Side-by-side mounting		Yes
Design of the thread of the screw for securing the equipment		M4
Tightening torque of the screw for securing the equipment	N·m	1.5
Width	mm	22.5
Height	mm	100
Depth	mm	94

Connections/ Terminals:





Type of electrical connection for main current circuit		spring-loaded terminals
Type of connectable conductor cross-section for main contacts		
<ul style="list-style-type: none"> • solid 		2x (0.5 ... 2.5 mm ²)
<ul style="list-style-type: none"> • finely stranded <ul style="list-style-type: none"> — with core end processing — without core end processing 		2x (0.5 ... 1.5 mm ²) 2x (0.5 ... 2.5 mm ²)
Type of connectable conductor cross-section		
<ul style="list-style-type: none"> • for AWG conductors <ul style="list-style-type: none"> — for main contacts — for auxiliary and control contacts 		2x (18 ... 14) 1x (AWG 20 ... 12)
Type of connectable conductor cross-section for auxiliary and control contacts		
<ul style="list-style-type: none"> • solid 		0.5 ... 1.5 mm ²
<ul style="list-style-type: none"> • finely stranded <ul style="list-style-type: none"> — with core end processing — without core end processing 		0.5 ... 2.5 mm ² 0.5 ... 2.5 mm ²
Connectable conductor cross-section		
<ul style="list-style-type: none"> • for main contacts <ul style="list-style-type: none"> — single or multi-stranded — finely stranded <ul style="list-style-type: none"> — with core end processing — without core end processing • for auxiliary and control contacts <ul style="list-style-type: none"> — solid — finely stranded <ul style="list-style-type: none"> — with core end processing — without core end processing 	mm ² mm ² mm ² mm ² mm ² mm ²	0.5 ... 2.5 0.5 ... 1.5 0.5 ... 2.5 0.5 ... 1.5 0.5 ... 2.5 0.5 ... 2.5
AWG number as coded connectable conductor cross section		
<ul style="list-style-type: none"> • for main contacts • for auxiliary and control contacts 		10 ... 14 20 ... 12
Type of electrical connection for auxiliary and control current circuit		spring-loaded terminals

Wire stripping length of the cable

- for main contacts
- for auxiliary and control contacts

mm	7
mm	7

Certificates/ approvals:

General Product Approval	EMC	Declaration of Conformity	Test Certificates
 CSA	 UL		 C-TICK
 EG-Konf.			spezielle Prüfbescheinigungen n

Test Certificates	other
Typprüfbescheinigung/Werkszeugnis	Umweltbestätigung

Further information**Short-circuit protection, design of the fuse link**

https://www.automation.siemens.com/cd-static/material/info/3RF23_eng.pdf

Information- and Downloadcenter (Catalogs, Brochures,...)

<http://www.siemens.com/industrial-controls/catalogs>

Industry Mall (Online ordering system)

<http://www.siemens.com/industrymall>

Cax online generator

<http://support.automation.siemens.com/WW/CAXorder/default.aspx?lang=en&mlfb=3RF23102AA02>

Service&Support (Manuals, Certificates, Characteristics, FAQs,...)

<https://support.industry.siemens.com/cs/ww/en/ps/3RF23102AA02>

Image database (product images, 2D dimension drawings, 3D models, device circuit diagrams, EPLAN macros, ...)

http://www.automation.siemens.com/bilddb/cax_de.aspx?mlfb=3RF23102AA02&lang=en

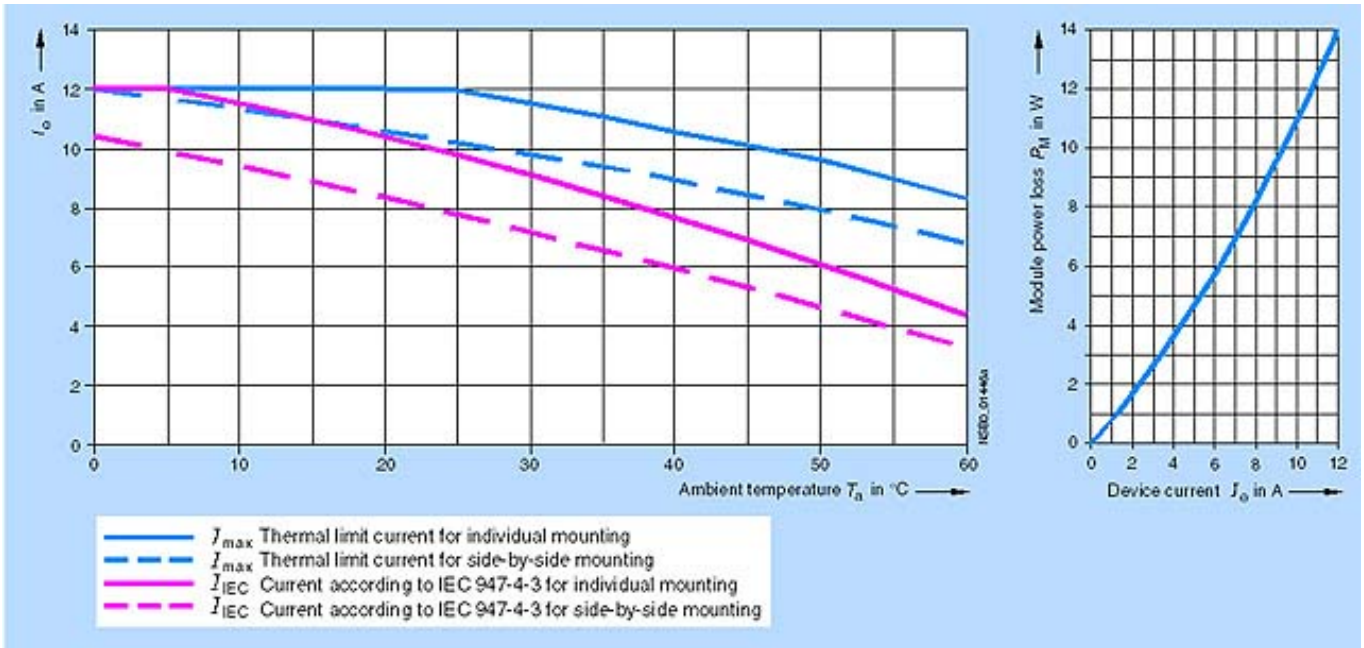
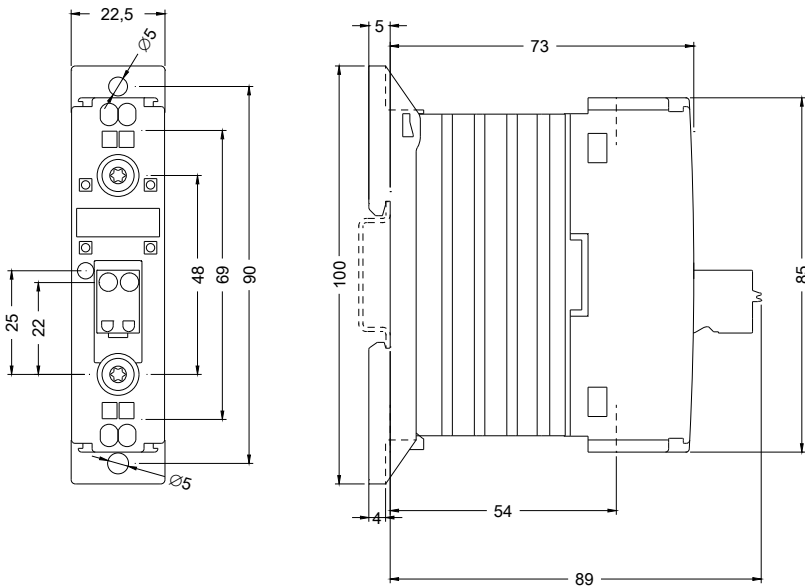

last modified:

17.07.2015