

SEMI-COND. CONTACTOR 3RF2,1-PH. AC 51 30A /  
AC15 15A 40 DEG. C 48-600 V / 110-230 V AC  
INSTANTANEOUS SWITCHING



General technical data:		
product brand name		SIRIUS
Product designation		solid-state contactor
Product function		instantaneous switching
Number of poles for main current circuit		1
Protection class IP		IP20
Product designation _1 of the accessories that can be ordered		terminal cover
Manufacturer article number _1 of the accessories that can be ordered		<a href="#">3RF2900-3PA88</a>
Product designation _2 of the accessories that can be ordered		power regulator
Manufacturer article number _2 of the accessories that can be ordered		<a href="#">3RF2950-0HA36</a>
Product designation _4 of the accessories that can be ordered		load monitoring
Manufacturer article number _4 of the accessories that can be ordered		<a href="#">3RF2950-0GA36</a>
Ambient temperature		
<ul style="list-style-type: none"> <li>during operation</li> </ul>	°C	-25 ... +60

• during storage	°C	-55 ... +80
Installation altitude at height above sea level maximum	m	1 000
Vibration resistance acc. to IEC 60068-2-6		2g
Shock resistance acc. to IEC 60068-2-27		15g / 11 ms
Equipment marking acc. to DIN 40719 extended according to IEC 204-2 acc. to IEC 750		K
Equipment marking acc. to DIN EN 61346-2		Q
Number of NC contacts for auxiliary contacts		0
Number of NO contacts for auxiliary contacts		0
Number of CO contacts for auxiliary contacts		0

#### Main circuit:

Number of NO contacts for main contacts		1
Number of NC contacts for main contacts		0
Operating current		
• at AC-1 at 400 V Rated value	A	30
• at AC-51 Rated value	A	30
Operating current minimum	mA	500
Operating voltage at AC		
• at 50 Hz Rated value	V	48 ... 600
• at 60 Hz Rated value	V	48 ... 600
Operating range relative to the operating voltage at AC		
• at 50 Hz	V	40 ... 660
• at 60 Hz	V	40 ... 660
Operating frequency Rated value	Hz	50 ... 60
Insulation voltage Rated value	V	600
Rate of voltage rise at the thyristor for main contacts maximum permissible	V/μs	1 000
Blocking voltage at the thyristor for main contacts maximum permissible	V	1 600
Reverse current of the thyristor	mA	10
Derating temperature	°C	40
Active power loss total typical	W	33
Surge current resistance Rated value	A	600
I <sup>2</sup> t value maximum	A <sup>2</sup> ·s	1 800

#### Control circuit/ Control:

Control supply voltage frequency		
• 1 Rated value	Hz	50
• 2 Rated value	Hz	60
Type of voltage of the control supply voltage		AC
Control supply voltage 1		
• at AC		

— at 50 Hz Initial rated value	V	110
— at 50 Hz Final rated value	V	230
— at 60 Hz Initial rated value	V	110
— at 60 Hz Final rated value	V	230
<b>Control supply voltage</b>		
• at AC		
— at 50 Hz Full-scale value for signal<0> recognition	V	40
— at 60 Hz Full-scale value for signal<0> recognition	V	40
<b>Symmetrical line frequency tolerance</b>	Hz	5
<b>Control current</b>		
• at minimum control supply voltage		
— at AC	mA	2
• at AC Rated value	mA	15

#### Installation/ mounting/ dimensions:





<b>Mounting type</b>		screw and snap-on mounting onto 35 mm standard mounting rail
<b>Mounting type Side-by-side mounting</b>		Yes
<b>Design of the thread of the screw for securing the equipment</b>		M4
<b>Tightening torque of the screw for securing the equipment</b>	N·m	1.5
<b>Width</b>	mm	45
<b>Height</b>	mm	100
<b>Depth</b>	mm	156

#### Connections/ Terminals:

<b>Type of electrical connection for main current circuit</b>		screw-type terminals
<b>Design of the thread of the connection screw for main contacts</b>		M4
<b>Tightening torque for main contacts with screw-type terminals</b>	N·m	2 ... 2.5
<b>Tightening torque [lbf·in] for main contacts with screw-type terminals</b>	lbf·in	18 ... 22
<b>Type of connectable conductor cross-section for main contacts</b>		
• solid		2x (1.5 ... 2.5 mm <sup>2</sup> ), 2x (2.5 ... 6 mm <sup>2</sup> )
• finely stranded		
— with core end processing		2x (1 ... 2.5 mm <sup>2</sup> ), 2x (2.5 ... 6 mm <sup>2</sup> ), 1x 10 mm <sup>2</sup>
<b>Type of connectable conductor cross-section</b>		
• for AWG conductors		
— for main contacts		2x (14 ... 10)
— for auxiliary and control contacts		1x (AWG 20 ... 12)

<b>Type of connectable conductor cross-section for auxiliary and control contacts</b>		
<ul style="list-style-type: none"> <li>• solid</li> </ul>		1x (0.5 ... 2.5 mm <sup>2</sup> ), 2x (0.5 ... 1.0 mm <sup>2</sup> )
<ul style="list-style-type: none"> <li>• finely stranded <ul style="list-style-type: none"> <li>— with core end processing</li> <li>— without core end processing</li> </ul> </li> </ul>		1x (0.5 ... 2.5 mm <sup>2</sup> ), 2x (0.5 ... 1.0 mm <sup>2</sup> ) 1x (0.5 ... 2.5 mm <sup>2</sup> ), 2x (0.5 ... 1.0 mm <sup>2</sup> )
<b>Connectable conductor cross-section</b>		
<ul style="list-style-type: none"> <li>• for main contacts <ul style="list-style-type: none"> <li>— single or multi-stranded</li> <li>— finely stranded</li> </ul> </li> </ul>	mm <sup>2</sup>	1.5 ... 6
<ul style="list-style-type: none"> <li> <ul style="list-style-type: none"> <li>— with core end processing</li> </ul> </li> </ul>	mm <sup>2</sup>	1 ... 10
<ul style="list-style-type: none"> <li>• for auxiliary and control contacts <ul style="list-style-type: none"> <li>— solid</li> <li>— finely stranded</li> </ul> </li> </ul>	mm <sup>2</sup>	0.5 ... 2.5
<ul style="list-style-type: none"> <li> <ul style="list-style-type: none"> <li>— with core end processing</li> <li>— without core end processing</li> </ul> </li> </ul>	mm <sup>2</sup>	0.5 ... 2.5
<b>AWG number as coded connectable conductor cross section</b>		
<ul style="list-style-type: none"> <li>• for main contacts</li> </ul>		10 ... 14
<ul style="list-style-type: none"> <li>• for auxiliary and control contacts</li> </ul>		20 ... 12
<b>Type of electrical connection for auxiliary and control current circuit</b>		screw-type terminals
<b>Design of the thread of the connection screw of the auxiliary and control contacts</b>		M3
<b>Wire stripping length of the cable</b>		
<ul style="list-style-type: none"> <li>• for main contacts</li> </ul>	mm	7
<ul style="list-style-type: none"> <li>• for auxiliary and control contacts</li> </ul>	mm	7
<b>Tightening torque for auxiliary and control contacts with screw-type terminals</b>	N·m	0.5 ... 0.6
<b>Tightening torque [lbf·in] for auxiliary and control contacts with screw-type terminals</b>	lbf·in	4.5 ... 5.3

Certificates/ approvals:

General Product Approval		EMC	Declaration of Conformity	Test Certificates
 CSA	 UL		 C-TICK	 EG-Konf.
				<a href="#">spezielle Prüfbescheinigungen</a>

Test Certificates	other
-------------------	-------

[Typprüfbescheinigung/Werkszeugnis](#)

[Umweltbestätigung](#)

#### Further information

**Short-circuit protection, design of the fuse link**

[https://www.automation.siemens.com/cd-static/material/info/3RF23\\_eng.pdf](https://www.automation.siemens.com/cd-static/material/info/3RF23_eng.pdf)

**Information- and Downloadcenter (Catalogs, Brochures,...)**

<http://www.siemens.com/industrial-controls/catalogs>

**Industry Mall (Online ordering system)**

<http://www.siemens.com/industrymall>

**Cax online generator**

<http://support.automation.siemens.com/WW/CAXorder/default.aspx?lang=en&mlfb=3RF23301BA26>

**Service&Support (Manuals, Certificates, Characteristics, FAQs,...)**

<https://support.industry.siemens.com/cs/ww/en/ps/3RF23301BA26>

**Image database (product images, 2D dimension drawings, 3D models, device circuit diagrams, EPLAN macros, ...)**

[http://www.automation.siemens.com/bilddb/cax\\_de.aspx?mlfb=3RF23301BA26&lang=en](http://www.automation.siemens.com/bilddb/cax_de.aspx?mlfb=3RF23301BA26&lang=en)

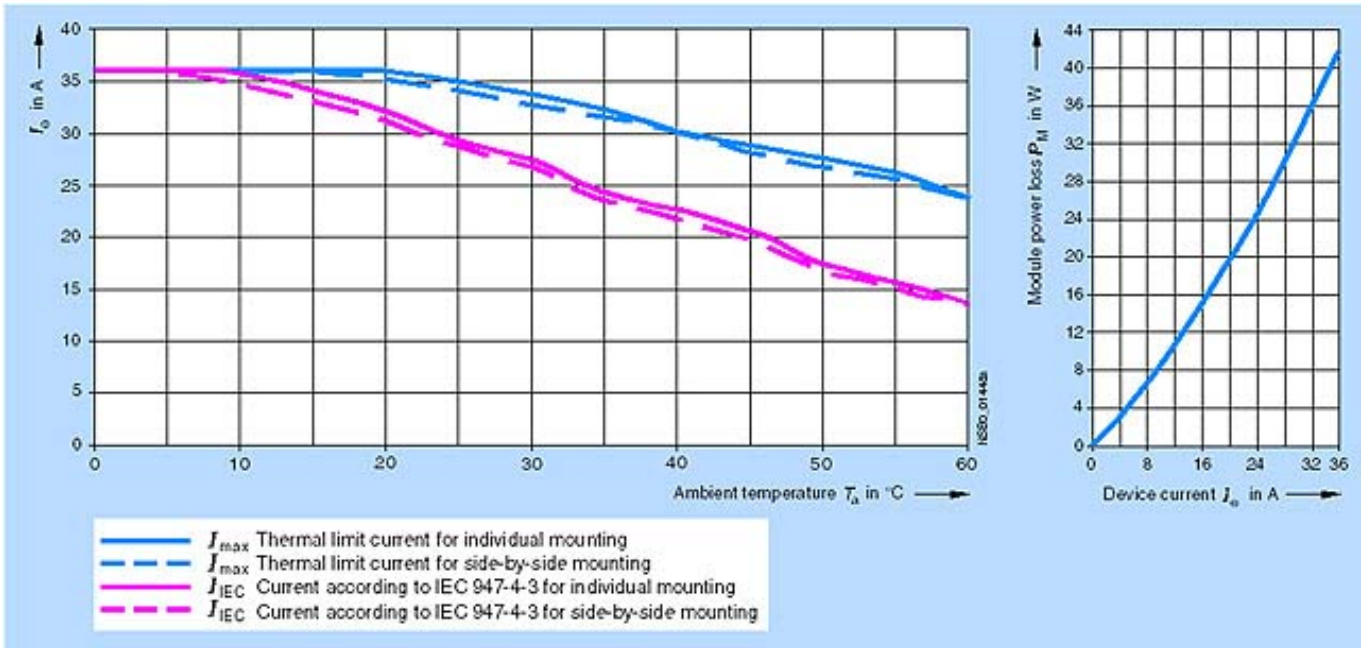
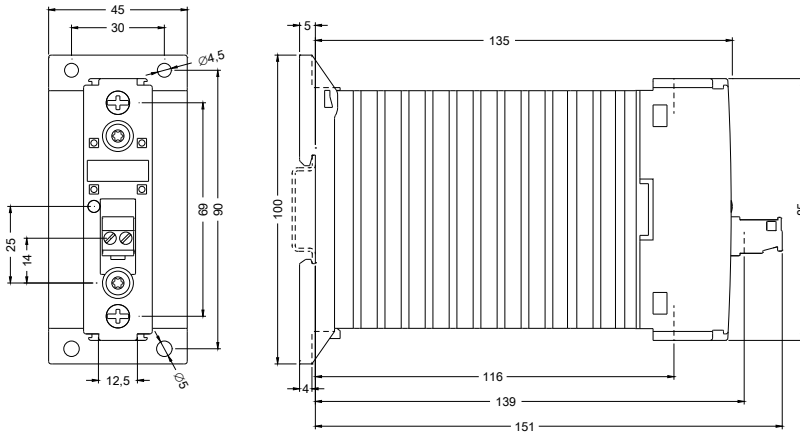

last modified:

17.07.2015