



SEMI-CONDUCTOR CONTACTOR 3-PH. 3RF2 AC51 30A
 40 DEG. C 48-600V / 230V AC 2-PHASE
 CONTROLLED SCREW TERMINAL BLOCKING
 VOLTAGE 1200V

General technical data:

product brand name		SIRIUS
Product designation		solid-state contactor
Product function		zero-point switching
Number of poles for main current circuit		3
Protection class IP		IP20
Ambient temperature		
• during operation	°C	-25 ... +60
• during storage	°C	-55 ... +80
Installation altitude at height above sea level maximum	m	1 000
Vibration resistance acc. to IEC 60068-2-6		2g
Shock resistance acc. to IEC 60068-2-27		15g / 11 ms
Equipment marking acc. to DIN 40719 extended according to IEC 204-2 acc. to IEC 750		K
Equipment marking acc. to DIN EN 61346-2		Q
Number of NC contacts for auxiliary contacts		0
Number of NO contacts for auxiliary contacts		0
Number of CO contacts for auxiliary contacts		0

Main circuit:		
Number of NO contacts for main contacts		2
Number of NC contacts for main contacts		0
Operating current		
• at AC-1 at 400 V Rated value	A	30
• at AC-51 Rated value	A	30
Reverse current of the thyristor	mA	10
Derating temperature	°C	40
Operating current minimum	mA	500
Surge current resistance Rated value	A	1 200
I ² t value maximum	A ² ·s	7 200
Operating voltage at AC		
• at 50 Hz Rated value	V	48 ... 600
• at 60 Hz Rated value	V	48 ... 600
Operating range relative to the operating voltage at AC		
• at 50 Hz	V	40 ... 660
• at 60 Hz	V	40 ... 660
Operating frequency Rated value	Hz	50 ... 60
Relative symmetrical tolerance of the operating frequency	%	10
Insulation voltage Rated value	V	600
Rate of voltage rise at the thyristor for main contacts maximum permissible	V/μs	1 000
Blocking voltage at the thyristor for main contacts maximum permissible	V	1 200
Short-circuit protection, design of the fuse link		
Control circuit/ Control:		
Type of voltage of the control supply voltage		AC
Control supply voltage 1		
• at AC		
— at 50 Hz	V	180 ... 230
— at 60 Hz	V	180 ... 230
Control supply voltage frequency		
• 1 Rated value	Hz	45
• 2 Rated value	Hz	66
Control supply voltage		
• at AC		
— at 50 Hz Full-scale value for signal<0> recognition	V	180
— at 60 Hz Full-scale value for signal<0> recognition	V	180
Symmetrical line frequency tolerance	Hz	5

Relative symmetrical tolerance of the supply voltage frequency	%	10
Control current		
<ul style="list-style-type: none"> • at minimum control supply voltage <ul style="list-style-type: none"> — at AC • at AC Rated value 	mA	2
	mA	15

Installation/ mounting/ dimensions:





Mounting type		screw and snap-on mounting onto 35 mm standard mounting rail
Mounting type Side-by-side mounting		Yes
Design of the thread of the screw for securing the equipment		M4
Tightening torque of the screw for securing the equipment	N·m	1.5
Width	mm	90
Height	mm	100
Depth	mm	112.5

Connections/ Terminals:

Type of electrical connection for main current circuit		screw-type terminals
Design of the thread of the connection screw for main contacts		M4
Tightening torque for main contacts with screw-type terminals	N·m	2 ... 2.5
Tightening torque [lbf·in] for main contacts with screw-type terminals	lbf·in	18 ... 22
Type of connectable conductor cross-section		
<ul style="list-style-type: none"> • for main contacts <ul style="list-style-type: none"> — solid — finely stranded — with core end processing • for AWG conductors <ul style="list-style-type: none"> — for main contacts — for auxiliary and control contacts • for auxiliary and control contacts <ul style="list-style-type: none"> — solid — finely stranded <ul style="list-style-type: none"> — with core end processing — without core end processing 		2x (1.5 ... 2.5 mm ²), 2x (2.5 ... 6 mm ²) 2x (1 ... 2.5 mm ²), 2x (2.5 ... 6 mm ²), 1x 10 mm ² 2x (14 ... 10) 1x (AWG 20 ... 12) 1x (0.5 ... 2.5 mm ²), 2x (0.5 ... 1.0 mm ²) 1x (0.5 ... 2.5 mm ²), 2x (0.5 ... 1.0 mm ²) 1x (0.5 ... 2.5 mm ²), 2x (0.5 ... 1.0 mm ²)
Connectable conductor cross-section		
<ul style="list-style-type: none"> • for main contacts <ul style="list-style-type: none"> — single or multi-stranded — finely stranded 	mm ²	1.5 ... 6

— with core end processing	mm ²	1 ... 10
• for auxiliary and control contacts		
— solid	mm ²	0.5 ... 2.5
— finely stranded		
— with core end processing	mm ²	0.5 ... 2.5
— without core end processing	mm ²	0.5 ... 2.5
AWG number as coded connectable conductor cross section		
• for main contacts		14 ... 10
• for auxiliary and control contacts		20 ... 12
Type of electrical connection for auxiliary and control current circuit		screw-type terminals
Design of the thread of the connection screw of the auxiliary and control contacts		M3
Wire stripping length of the cable		
• for main contacts	mm	7
• for auxiliary and control contacts	mm	7
Tightening torque for auxiliary and control contacts with screw-type terminals	N·m	0.5 ... 0.6
Tightening torque [lbf·in] for auxiliary and control contacts with screw-type terminals	lbf·in	7.5 ... 5.3

Certificates/ approvals:

General Product Approval	EMC	Declaration of Conformity	Test Certificates
 CSA	 UL	 EAC	 C-TICK
		 EG-Konf.	Typprüfbescheinigung/Werkszeugnis

other

[Umweltbestätigung](#)

Further information

Short-circuit protection, design of the fuse link

https://www.automation.siemens.com/cd-static/material/info/3RF24_eng.pdf

Information- and Downloadcenter (Catalogs, Brochures,...)

<http://www.siemens.com/industrial-controls/catalogs>

Industry Mall (Online ordering system)

<http://www.siemens.com/industrymall>

Cax online generator

<http://support.automation.siemens.com/WW/CAXorder/default.aspx?lang=en&mlfb=3RF24301AB55>

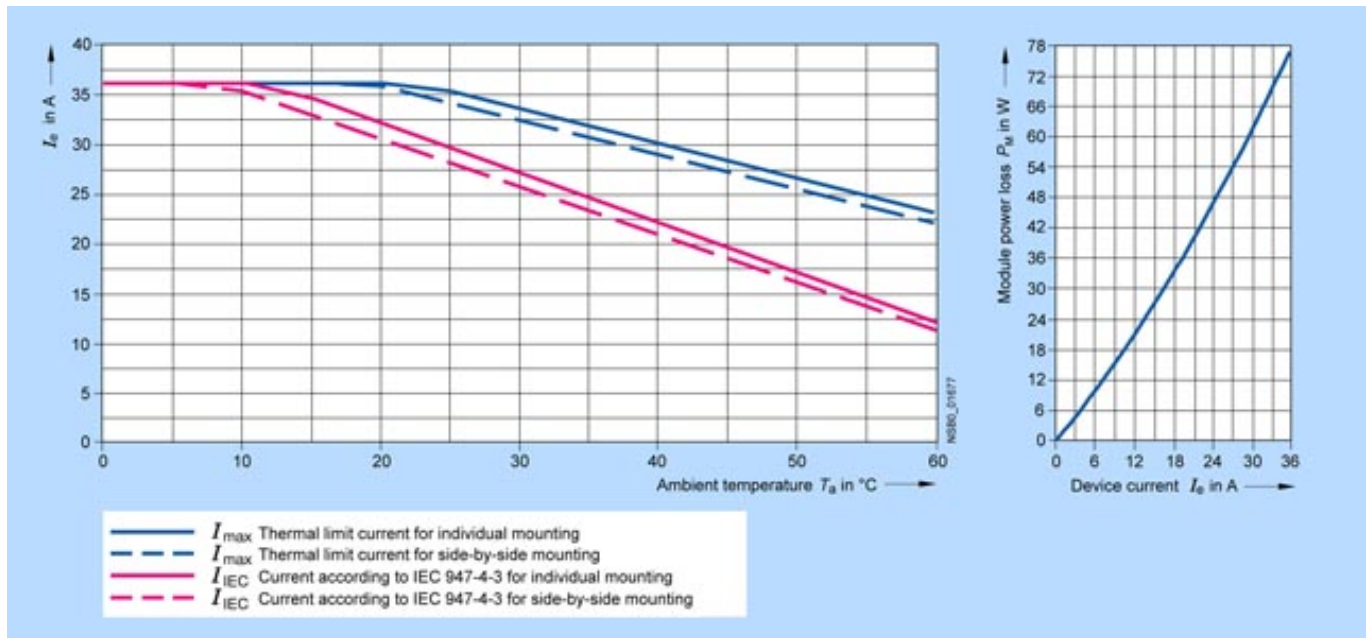
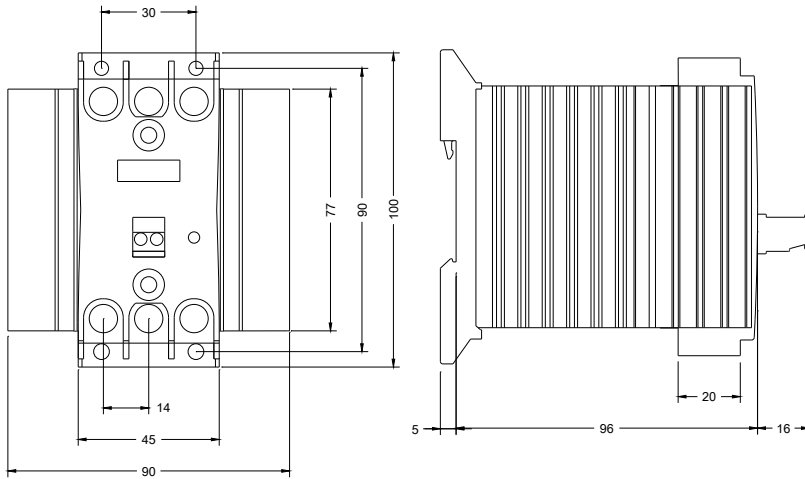

last modified:

17.07.2015