

SEMI-CONDUCTOR CONTACT.3-PH.3RF2 AC51 10A  
 40 DEG. C 48-600V / 230V AC 3-PHASE  
 CONTROLLED SPRING-LOADED CONNECTION  
 BLOCKING VOLTAGE 1200V



Figure similar

General technical data:		
product brand name		SIRIUS
Product designation		solid-state contactor
Product function		zero-point switching
Number of poles for main current circuit		3
Protection class IP		IP20
Ambient temperature		
• during operation	°C	-25 ... +60
• during storage	°C	-55 ... +80
Installation altitude at height above sea level maximum	m	1 000
Vibration resistance acc. to IEC 60068-2-6		2g
Shock resistance acc. to IEC 60068-2-27		15g / 11 ms
Equipment marking acc. to DIN 40719 extended according to IEC 204-2 acc. to IEC 750		K
Equipment marking acc. to DIN EN 61346-2		Q
Number of NC contacts for auxiliary contacts		0
Number of NO contacts for auxiliary contacts		0
Number of CO contacts for auxiliary contacts		0

Main circuit:		
Number of NO contacts for main contacts		3
Number of NC contacts for main contacts		0
Operating current		
• at AC-1 at 400 V Rated value	A	10
• at AC-51 Rated value	A	10
Reverse current of the thyristor	mA	10
Derating temperature	°C	40
Operating current minimum	mA	500
Surge current resistance Rated value	A	300
I <sup>2</sup> t value maximum	A <sup>2</sup> ·s	450
Operating voltage at AC		
• at 50 Hz Rated value	V	48 ... 600
• at 60 Hz Rated value	V	48 ... 600
Operating range relative to the operating voltage at AC		
• at 50 Hz	V	40 ... 660
• at 60 Hz	V	40 ... 660
Operating frequency Rated value	Hz	50 ... 60
Relative symmetrical tolerance of the operating frequency	%	10
Insulation voltage Rated value	V	600
Rate of voltage rise at the thyristor for main contacts maximum permissible	V/μs	500
Blocking voltage at the thyristor for main contacts maximum permissible	V	1 200
Short-circuit protection, design of the fuse link		
Control circuit/ Control:		
Type of voltage of the control supply voltage		AC
Control supply voltage 1		
• at AC		
— at 50 Hz	V	180 ... 230
— at 60 Hz	V	180 ... 230
Control supply voltage frequency		
• 1 Rated value	Hz	45
• 2 Rated value	Hz	66
Control supply voltage		
• at AC		
— at 50 Hz Full-scale value for signal<0> recognition	V	180
— at 60 Hz Full-scale value for signal<0> recognition	V	180
Symmetrical line frequency tolerance	Hz	5





<b>Relative symmetrical tolerance of the supply voltage frequency</b>	%	10
<b>Control current</b>		
<ul style="list-style-type: none"> <li>• at minimum control supply voltage <ul style="list-style-type: none"> <li>— at AC</li> </ul> </li> <li>• at AC Rated value</li> </ul>	mA	2
	mA	15

Installation/ mounting/ dimensions:		
<b>Mounting type</b>		screw and snap-on mounting onto 35 mm standard mounting rail
<b>Mounting type Side-by-side mounting</b>		Yes
<b>Design of the thread of the screw for securing the equipment</b>		M4
<b>Tightening torque of the screw for securing the equipment</b>	N·m	1.5
<b>Width</b>	mm	45
<b>Height</b>	mm	100
<b>Depth</b>	mm	104.5

Connections/ Terminals:		
<b>Type of electrical connection for main current circuit</b>		spring-loaded terminals
<b>Type of connectable conductor cross-section</b>		
<ul style="list-style-type: none"> <li>• for main contacts <ul style="list-style-type: none"> <li>— solid</li> <li>— finely stranded</li> <li>— with core end processing</li> <li>— without core end processing</li> </ul> </li> <li>• for AWG conductors <ul style="list-style-type: none"> <li>— for main contacts</li> <li>— for auxiliary and control contacts</li> </ul> </li> <li>• for auxiliary and control contacts <ul style="list-style-type: none"> <li>— solid</li> <li>— finely stranded <ul style="list-style-type: none"> <li>— with core end processing</li> <li>— without core end processing</li> </ul> </li> </ul> </li> </ul>		2x (0.5 ... 2.5 mm <sup>2</sup> )  2x (0.5 ... 1.5 mm <sup>2</sup> ) 2x (0.5 ... 2.5 mm <sup>2</sup> )  2x (18 ... 14) 1x (AWG 20 ... 12)  0.5 ... 1.5 mm <sup>2</sup>  0.5 ... 2.5 mm <sup>2</sup> 0.5 ... 2.5 mm <sup>2</sup>
<b>Connectable conductor cross-section</b>		
<ul style="list-style-type: none"> <li>• for main contacts <ul style="list-style-type: none"> <li>— single or multi-stranded</li> <li>— finely stranded <ul style="list-style-type: none"> <li>— with core end processing</li> <li>— without core end processing</li> </ul> </li> </ul> </li> <li>• for auxiliary and control contacts <ul style="list-style-type: none"> <li>— solid</li> <li>— finely stranded</li> </ul> </li> </ul>	mm <sup>2</sup>	0.5 ... 2.5
	mm <sup>2</sup>	0.5 ... 1.5
	mm <sup>2</sup>	0.5 ... 2.5
	mm <sup>2</sup>	0.5 ... 1.5

— with core end processing	mm <sup>2</sup>	0.5 ... 2.5
— without core end processing	mm <sup>2</sup>	0.5 ... 2.5
<b>AWG number as coded connectable conductor cross section</b>		
• for main contacts		14 ... 10
• for auxiliary and control contacts		20 ... 12
<b>Type of electrical connection for auxiliary and control current circuit</b>		spring-loaded terminals
<b>Wire stripping length of the cable</b>		
• for main contacts	mm	10
• for auxiliary and control contacts	mm	10

#### Certificates/ approvals:

General Product Approval	EMC	Declaration of Conformity	Test Certificates
 CSA	 UL	 EAC	 C-TICK
		 EG-Konf.	<a href="#">Typprüfbescheinigung/Werkszeugnis</a>

#### other

[Umweltbestätigung](#)

#### Further information

##### Short-circuit protection, design of the fuse link

[https://www.automation.siemens.com/cd-static/material/info/3RF24\\_eng.pdf](https://www.automation.siemens.com/cd-static/material/info/3RF24_eng.pdf)

##### Information- and Downloadcenter (Catalogs, Brochures,...)

<http://www.siemens.com/industrial-controls/catalogs>

##### Industry Mall (Online ordering system)

<http://www.siemens.com/industrymall>

##### Cax online generator

<http://support.automation.siemens.com/WW/CAXorder/default.aspx?lang=en&mlfb=3RF24102AC55>

##### Service&Support (Manuals, Certificates, Characteristics, FAQs,...)

<https://support.industry.siemens.com/cs/ww/en/ps/3RF24102AC55>

##### Image database (product images, 2D dimension drawings, 3D models, device circuit diagrams, EPLAN macros, ...)

[http://www.automation.siemens.com/bilddb/cax\\_de.aspx?mlfb=3RF24102AC55&lang=en](http://www.automation.siemens.com/bilddb/cax_de.aspx?mlfb=3RF24102AC55&lang=en)

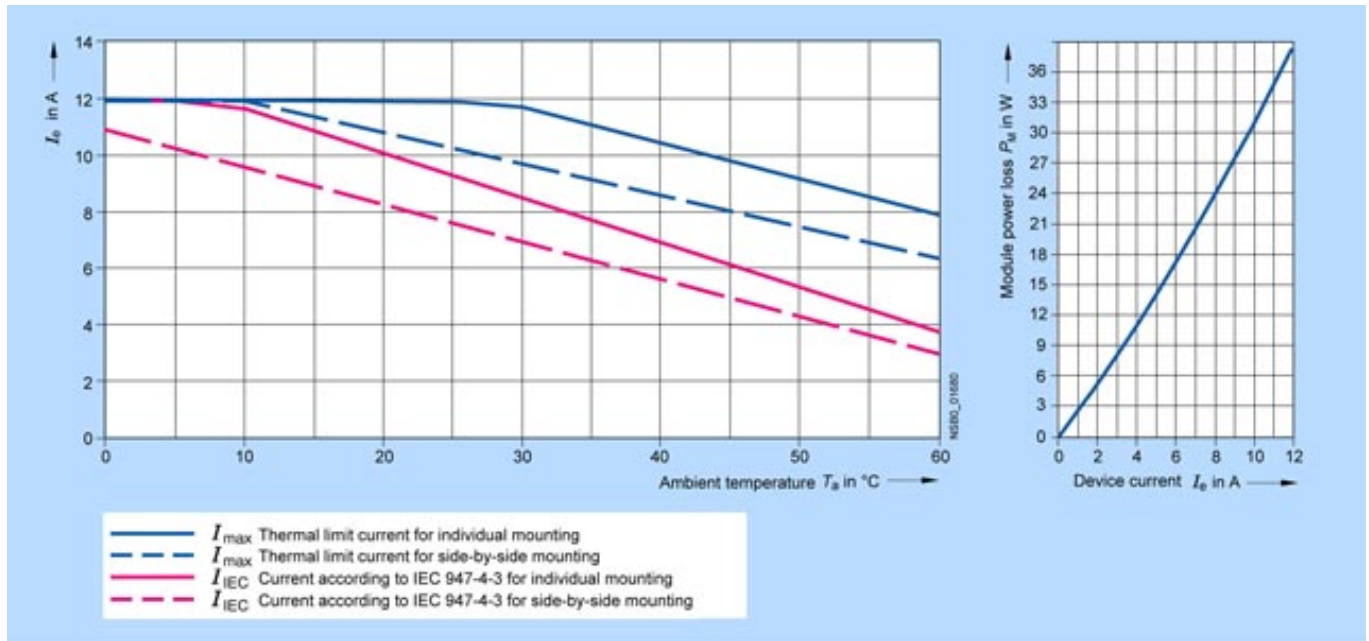
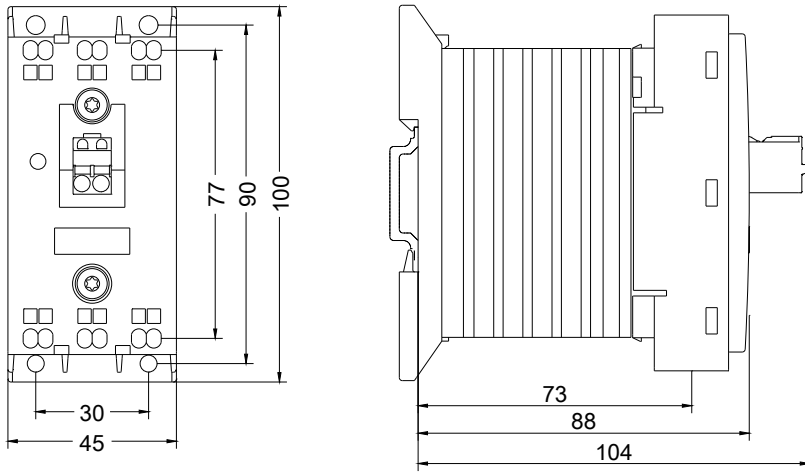

last modified:

17.07.2015