

Data sheet | Item number: 2000-5310/102-000

3-conductor actuator supply terminal block; for PNP-(high-side) switching actuators; with ground connection via push-in type jumper bars; 1 mm²; Push-in CAGE CLAMP®

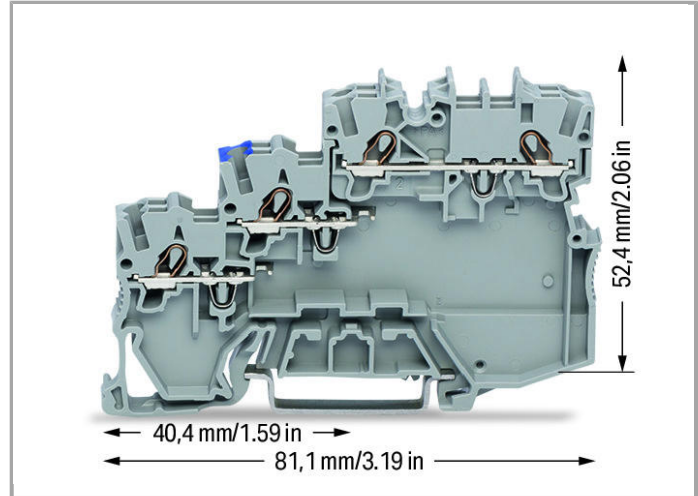

www.wago.com/2000-5310/102-000

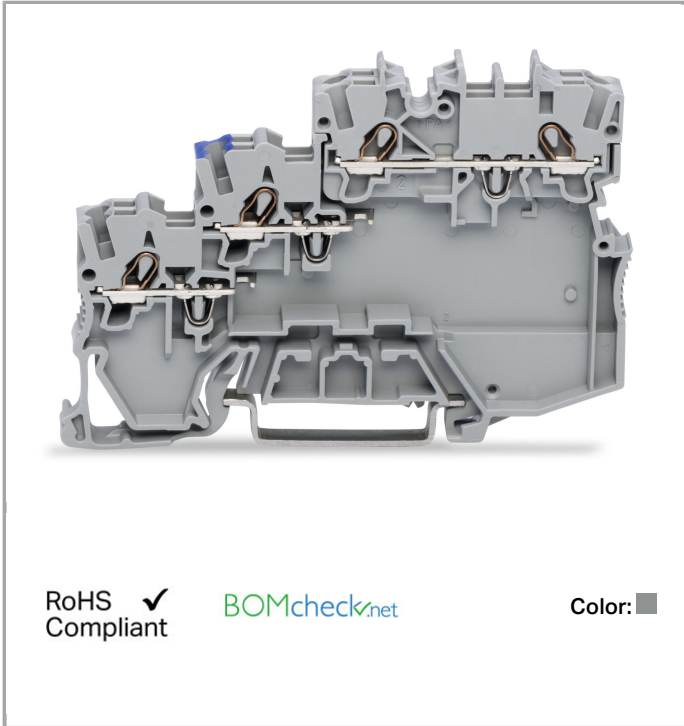

RoHS Compliant

[BOMcheck.net](https://www.bomcheck.net)

Color: ■

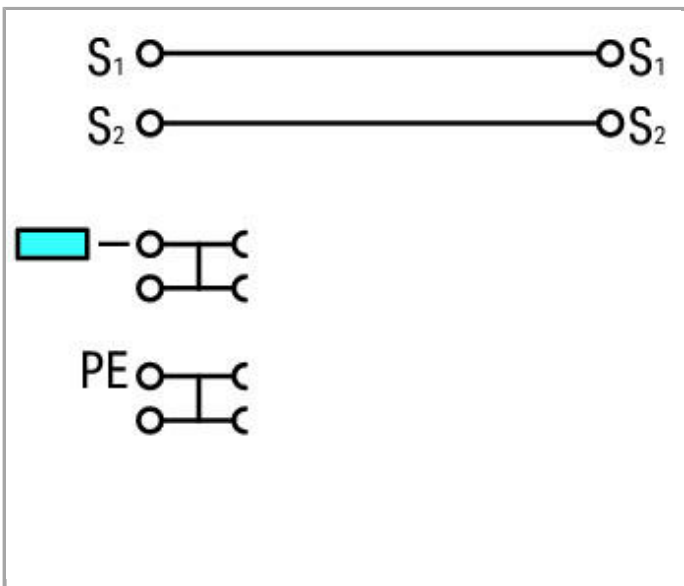

Item description

3.5 mm spacing per signal (2 x 3.5 mm = 7 mm)

The double spacing per pole of this terminal block series maximizes connectivity. For example, ten sensors may be connected using only five sensor terminal blocks plus a power supply terminal block.

Data

Electrical data

Ratings per IEC/EN 60664-1

Rated voltage (III / 3)	250 V
Rated impulse voltage (III / 3)	4 kV
Rated current	13.5 A
Legend (ratings)	(III / 3) $\hat{=}$ Overvoltage category III / Pollution degree 3

Approvals per UL 1059

Rated voltage UL (Use Group C)	300 V
Rated current UL (Use Group C)	15 A

Approvals per CSA

Rated voltage CSA (Use Group C)	300 V
Rated current CSA (Use Group C)	10 A

Connection data

Connection technology	Push-in CAGE CLAMP®
Actuation type	Push-in Operating tool
Connectable conductor materials	Copper
Nominal cross section	1 mm ²
Solid conductor	0.14 ... 1.5 mm ² / 24 ... 16 AWG
Solid conductor, push-in termination	0.5 ... 1.5 mm ² / 20 ... 16 AWG
Fine-stranded conductor	0.14 ... 1.5 mm ² / 24 ... 16 AWG
Fine-stranded conductor with ferrule, push-in termination, from	0.5 mm ² / 20 AWG
Strip length	9 ... 11 mm / 0.35 ... 0.43 Inch
Total number of connection points	8
Total number of potentials	4
Type of wiring	Front-entry wiring

Geometrical Data

Width	7 mm / 0.276 inch
Height from upper-edge of DIN-35 rail	52.4 mm / 2.063 inch

Mechanical data

Design	horizontal
--------	------------

Type of mounting	DIN-35 rail
Marking level	Center/side marking

Material Data



Color	gray
Insulating material	Polyamide 66 (PA 66)
Weight	14.91 g

Commercial data

Country of origin	DE
GTIN	4055143393454
Customs Tariff No.	85369010000

Approvals / Certificates

Country specific Approvals



Logo	Approval	Certificate name
	CCA DEKRA Certification B.V.	71-102841
	CCA DEKRA Certification B.V.	NTR NL 7671
	CSA DEKRA Certification B.V.	2130762



















UL-Approvals

















Logo	Approval	Certificate name
	UL UL International Germany GmbH	E45172 sec.55

















Compatible products













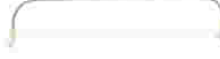

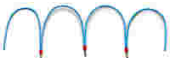
check







	Item no.: 2000-510 TOPJOB®S L-type test plug module; modular; for jumper contact slot	www.wago.com/2000-510
	Item no.: 2000-552 Modular TOPJOB®S connector; modular; for jumper contact slot; 2-pole	www.wago.com/2000-552

	Item no.: 2000-553 Modular TOPJOB®S connector; modular; for jumper contact slot; 3-pole	www.wago.com/2000-553
	Item no.: 2000-554 Modular TOPJOB®S connector; modular; for jumper contact slot; 4-pole	www.wago.com/2000-554
	Item no.: 2000-555 Modular TOPJOB®S connector; modular; for jumper contact slot; 5-pole	www.wago.com/2000-555
	Item no.: 2000-556 Modular TOPJOB®S connector; modular; for jumper contact slot; 6-pole	www.wago.com/2000-556
	Item no.: 2000-557 Modular TOPJOB®S connector; modular; for jumper contact slot; 7-pole	www.wago.com/2000-557
	Item no.: 2000-558 Modular TOPJOB®S connector; modular; for jumper contact slot; 8-pole	www.wago.com/2000-558
	Item no.: 2000-559 Modular TOPJOB®S connector; modular; for jumper contact slot; 9-pole	www.wago.com/2000-559
	Item no.: 2000-560 Modular TOPJOB®S connector; modular; for jumper contact slot; 10-pole	www.wago.com/2000-560
	Item no.: 2009-174 Test plug adapter; for 4 mm Ø test plugs; for testing TOPJOB®S rail-mounted terminal blocks	www.wago.com/2009-174
	Item no.: 2009-182 Testing tap; for max. 2.5 mm ² ; tool-free connection for individual test wires 0.08 - 2.5 mm	www.wago.com/2009-182
	Item no.: 210-136 Test plug; 2 mm Ø; with 500 mm cable	www.wago.com/210-136
	Item no.: 210-137 Test plug; 2.3 mm Ø; with 500 mm cable	www.wago.com/210-137
Jumper		
	Item no.: 2000-402 Push-in type jumper bar; insulated; 2-way; Nominal current 14 A	www.wago.com/2000-402
	Item no.: 2000-402/000-005 Push-in type jumper bar; insulated; 2-way; Nominal current 14 A	www.wago.com/2000-402/000-005
	Item no.: 2000-402/000-006 Push-in type jumper bar; insulated; 2-way; Nominal current 14 A	www.wago.com/2000-402/000-006
	Item no.: 2000-402/000-018 Push-in type jumper bar; insulated; 2-way; Nominal current 14 A	www.wago.com/2000-402/000-018
	Item no.: 2000-403 Push-in type jumper bar; insulated; 3-way; Nominal current 14 A	www.wago.com/2000-403
	Item no.: 2000-403/000-005 Push-in type jumper bar; insulated; 3-way; Nominal current 14 A	www.wago.com/2000-403/000-005









	Item no.: 2000-403/000-006 Push-in type jumper bar; insulated; 3-way; Nominal current 14 A	www.wago.com/2000-403/000-006
	Item no.: 2000-404 Push-in type jumper bar; insulated; 4-way; Nominal current 14 A	www.wago.com/2000-404
	Item no.: 2000-404/000-005 Push-in type jumper bar; insulated; 4-way; Nominal current 14 A	www.wago.com/2000-404/000-005
	Item no.: 2000-404/000-006 Push-in type jumper bar; insulated; 4-way; Nominal current 14 A	www.wago.com/2000-404/000-006
	Item no.: 2000-405 Push-in type jumper bar; insulated; 5-way; Nominal current 14 A	www.wago.com/2000-405
	Item no.: 2000-405/000-005 Push-in type jumper bar; insulated; 5-way; Nominal current 14 A	www.wago.com/2000-405/000-005
	Item no.: 2000-405/000-006 Push-in type jumper bar; insulated; 5-way; Nominal current 14 A	www.wago.com/2000-405/000-006
	Item no.: 2000-405/011-000 Star point jumper; insulated; 3-way (1-3-5); IN = IN terminal block	www.wago.com/2000-405/011-000
	Item no.: 2000-406 Push-in type jumper bar; insulated; 6-way; Nominal current 14 A	www.wago.com/2000-406
	Item no.: 2000-406/000-005 Push-in type jumper bar; insulated; 6-way; Nominal current 14 A	www.wago.com/2000-406/000-005
	Item no.: 2000-406/000-006 Push-in type jumper bar; insulated; 6-way; Nominal current 14 A	www.wago.com/2000-406/000-006
	Item no.: 2000-406/020-000 Delta jumper; insulated; 1-2 3-4 5-6; IN = IN terminal block	www.wago.com/2000-406/020-000
	Item no.: 2000-407 Push-in type jumper bar; insulated; 7-way; Nominal current 14 A	www.wago.com/2000-407
	Item no.: 2000-407/000-005 Push-in type jumper bar; insulated; 7-way; Nominal current 14 A	www.wago.com/2000-407/000-005
	Item no.: 2000-407/000-006 Push-in type jumper bar; insulated; 7-way; Nominal current 14 A	www.wago.com/2000-407/000-006
	Item no.: 2000-408 Push-in type jumper bar; insulated; 8-way; Nominal current 14 A	www.wago.com/2000-408

	Item no.: 2000-408/000-005 Push-in type jumper bar; insulated; 8-way; Nominal current 14 A	www.wago.com/2000-408/000-005
	Item no.: 2000-408/000-006 Push-in type jumper bar; insulated; 8-way; Nominal current 14 A	www.wago.com/2000-408/000-006
	Item no.: 2000-409 Push-in type jumper bar; insulated; 9-way; Nominal current 14 A	www.wago.com/2000-409
	Item no.: 2000-409/000-005 Push-in type jumper bar; insulated; 9-way; Nominal current 14 A	www.wago.com/2000-409/000-005
	Item no.: 2000-409/000-006 Push-in type jumper bar; insulated; 9-way; Nominal current 14 A	www.wago.com/2000-409/000-006
	Item no.: 2000-410 Push-in type jumper bar; insulated; 10-way; Nominal current 14 A	www.wago.com/2000-410
	Item no.: 2000-410/000-005 Push-in type jumper bar; insulated; 10-way; Nominal current 14 A	www.wago.com/2000-410/000-005
	Item no.: 2000-410/000-006 Push-in type jumper bar; insulated; 10-way; Nominal current 14 A	www.wago.com/2000-410/000-006
	Item no.: 2000-433 Push-in type jumper bar; insulated; from 1 to 3; Nominal current 14 A	www.wago.com/2000-433
	Item no.: 2000-433/000-005 Push-in type jumper bar; insulated; from 1 to 3; Nominal current 14 A	www.wago.com/2000-433/000-005
	Item no.: 2000-433/000-006 Push-in type jumper bar; insulated; from 1 to 3; Nominal current 14 A	www.wago.com/2000-433/000-006
	Item no.: 2000-434 Push-in type jumper bar; insulated; from 1 to 4; Nominal current 14 A	www.wago.com/2000-434
	Item no.: 2000-435 Push-in type jumper bar; insulated; from 1 to 5; Nominal current 14 A	www.wago.com/2000-435
	Item no.: 2000-436 Push-in type jumper bar; insulated; from 1 to 6; Nominal current 14 A	www.wago.com/2000-436
	Item no.: 2000-437 Push-in type jumper bar; insulated; from 1 to 7; Nominal current 14 A	www.wago.com/2000-437
	Item no.: 2000-438 Push-in type jumper bar; insulated; from 1 to 8; Nominal current 14 A	www.wago.com/2000-438
	Item no.: 2000-439 Push-in type jumper bar; insulated; from 1 to 9; Nominal current 14 A	www.wago.com/2000-439

	Item no.: 2000-440 Push-in type jumper bar; insulated; from 1 to 10; Nominal current 14 A	www.wago.com/2000-440
	Item no.: 2009-402 Push-in type wire jumper; insulated; wire length 60 mm; Conductor cross section 0.75 mm ² ; suitable for 2000 and 2020 Series rail-mounted terminal blocks	www.wago.com/2009-402
	Item no.: 2009-404 Push-in type wire jumper; insulated; wire length 110 mm; Conductor cross section 0.75 mm ² ; suitable for 2000 and 2020 Series rail-mounted terminal blocks	www.wago.com/2009-404
	Item no.: 2009-406 Push-in type wire jumper; insulated; wire length 250 mm; Conductor cross section 0.75 mm ² ; suitable for 2000 and 2020 Series rail-mounted terminal blocks	www.wago.com/2009-406
	Item no.: 210-103 Wire commoning chain; insulated; 50 connections	www.wago.com/210-103
	Item no.: 210-123 Wire commoning chain; insulated; 50 connections	www.wago.com/210-123
Protective Warning Marker		
	Item no.: 2000-115 Protective warning marker; with high-voltage symbol, black; for 5 terminal blocks	www.wago.com/2000-115
tools		
	Item no.: 210-647 Operating tool with partially insulated shaft; Blade (2.5 x 0.4) mm; short	www.wago.com/210-647
	Item no.: 210-648 Operating tool with partially insulated shaft; Blade (2.5 x 0.4) mm; short; angled	www.wago.com/210-648
	Item no.: 210-719 Operating tool with partially insulated shaft; Type 1, blade (2.5 x 0.4) mm	www.wago.com/210-719
Marking accessories		
	Item no.: 2009-110 Marking strips; on reel; not stretchable; plain; snap-on type	www.wago.com/2009-110
	Item no.: 2009-113 WMB-Inline; for smartPRINTER; on reel; plain; snap-on type	www.wago.com/2009-113
	Item no.: 2009-113/000-002 WMB-Inline; for smartPRINTER; on reel; plain; snap-on type	www.wago.com/2009-113/000-002
	Item no.: 2009-113/000-005 WMB-Inline; for smartPRINTER; on reel; plain; snap-on type	www.wago.com/2009-113/000-005
	Item no.: 2009-113/000-006 WMB-Inline; for smartPRINTER; on reel; plain; snap-on type	www.wago.com/2009-113/000-006
	Item no.: 2009-113/000-007 WMB-Inline; for smartPRINTER; on reel; plain; snap-on type	www.wago.com/2009-113/000-007

	Item no.: 2009-113/000-012 WMB-Inline; for smartPRINTER; on reel; plain; snap-on type	www.wago.com/2009-113/000-012
	Item no.: 2009-113/000-017 WMB-Inline; for smartPRINTER; on reel; plain; snap-on type	www.wago.com/2009-113/000-017
	Item no.: 2009-113/000-023 WMB-Inline; for smartPRINTER; on reel; plain; snap-on type	www.wago.com/2009-113/000-023
	Item no.: 2009-113/000-024 WMB-Inline; for smartPRINTER; on reel; plain; snap-on type	www.wago.com/2009-113/000-024
	Item no.: 2009-191 Group marker carrier	www.wago.com/2009-191
	Item no.: 793-3501 WMB marking card; as card; plain; snap-on type	www.wago.com/793-3501

Carrier rail

	Item no.: 210-112 Steel carrier rail; 35 x 7.5 mm; 1 mm thick; 2 m long; slotted; according to EN 60715; "Hole width 25 mm	www.wago.com/210-112
	Item no.: 210-113 Steel carrier rail; 35 x 7.5 mm; 1 mm thick; 2 m long; unslotted; according to EN 60715	www.wago.com/210-113
	Item no.: 210-114 Steel carrier rail; 35 x 15 mm; 1.5 mm thick; 2 m long; unslotted; similar to EN 60715	www.wago.com/210-114
	Item no.: 210-115 Steel carrier rail; 35 x 7.5 mm; 1 mm thick; 2 m long; slotted; according to EN 60715; "Hole width 18 mm	www.wago.com/210-115
	Item no.: 210-118 Steel carrier rail; 35 x 15 mm; 2.3 mm thick; 2 m long; unslotted; according to EN 60715	www.wago.com/210-118
	Item no.: 210-196 Aluminum carrier rail; 35 x 8.2 mm; 1.6 mm thick; 2 m long; unslotted; similar to EN 60715	www.wago.com/210-196
	Item no.: 210-197 Steel carrier rail; 35 x 15 mm; 1.5 mm thick; 2 m long; slotted; similar to EN 60715	www.wago.com/210-197
	Item no.: 210-198 Copper carrier rail; 35 x 15 mm; 2.3 mm thick; 2 m long; unslotted; according to EN 60715	www.wago.com/210-198

General accessories

	Item no.: 2000-121 Adaptor	www.wago.com/2000-121
--	--------------------------------------	--

ferrule

Item no.: 216-241 Ferrule; Sleeve for 0.5 mm ² / AWG 22; insulated; electro-tin plated; electrolytic copper; gastight	www.wago.com/216-241
--	--



crimped; acc. to DIN 46228, Part 4/09.90



Item no.: 216-242

Ferrule; Sleeve for 0.75 mm² / AWG 20; insulated; electro-tin plated; electrolytic copper; gastight www.wago.com/216-242
crimped; acc. to DIN 46228, Part 4/09.90



Item no.: 216-243

Ferrule; Sleeve for 1 mm² / AWG 18; insulated; electro-tin plated; electrolytic copper; gastight www.wago.com/216-243
crimped; acc. to DIN 46228, Part 4/09.90

End plate



Item no.: 2000-5391

End and intermediate plate; 1 mm thick; for 3-conductor terminal blocks

www.wago.com/2000-5391

Downloads

Documentation

Bid Text

2000-5310/102-000	Aug 13, 2018	DOCX 15.5 kB	Download
-------------------	--------------	-----------------	----------

smartDATA

CAD data

3D Download 2000-5310/102-000	URL	Download
-------------------------------	-----	----------

Subject to changes.