

Data sheet | Item number: 2000-5317/102-000

3-conductor actuator supply terminal block; for PNP-(high-side) switching actuators; with ground contact; 1 mm<sup>2</sup>; Push-in CAGE CLAMP®

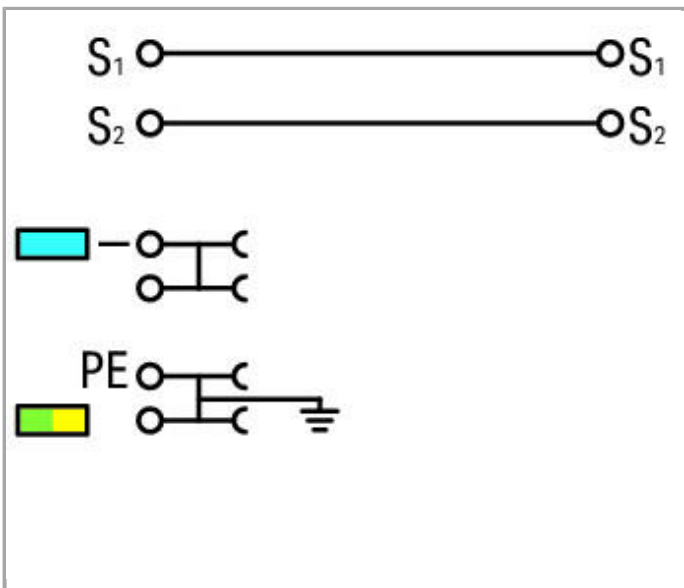

[www.wago.com/2000-5317/102-000](http://www.wago.com/2000-5317/102-000)

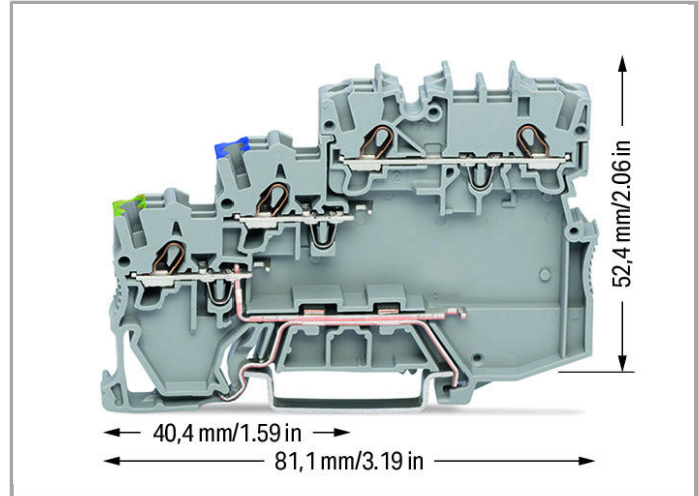
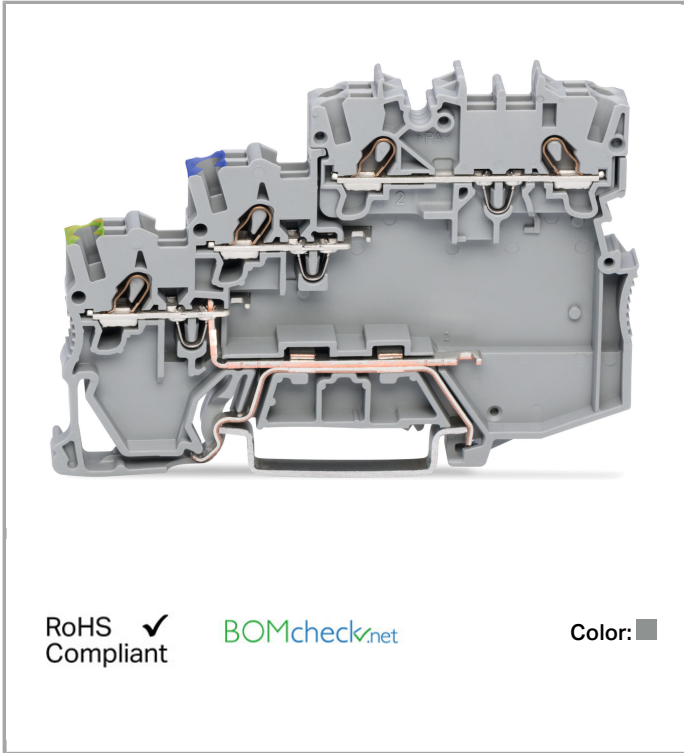

Item description

3.5 mm spacing per signal (2 x 3.5 mm = 7 mm)

The double spacing per pole of this terminal block series maximizes connectivity. For example, ten sensors may be connected using only five sensor terminal blocks plus a power supply terminal block.

## Data

### Electrical data

#### Ratings per IEC/EN 60664-1

Rated voltage (III / 3)	250 V
Rated impulse voltage (III / 3)	4 kV
Rated current	13.5 A
Legend (ratings)	(III / 3) $\triangleq$ Overvoltage category III / Pollution degree 3

#### Approvals per UL 1059

Rated voltage UL (Use Group C)	300 V
Rated current UL (Use Group C)	15 A

#### Approvals per CSA

Rated voltage CSA (Use Group C)	300 V
Rated current CSA (Use Group C)	10 A

### Connection data

Connection technology	Push-in CAGE CLAMP®
Actuation type	Push-in Operating tool
Connectable conductor materials	Copper
Nominal cross section	1 mm <sup>2</sup>
Solid conductor	0.14 ... 1.5 mm <sup>2</sup> / 24 ... 16 AWG
Solid conductor, push-in termination	0.5 ... 1.5 mm <sup>2</sup> / 20 ... 16 AWG
Fine-stranded conductor	0.14 ... 1.5 mm <sup>2</sup> / 24 ... 16 AWG
Fine-stranded conductor with ferrule, push-in termination, from	0.5 mm <sup>2</sup> / 20 AWG
Strip length	9 ... 11 mm / 0.35 ... 0.43 Inch
Total number of connection points	8
Total number of potentials	4
Type of wiring	Front-entry wiring

### Geometrical Data

Width	7 mm / 0.276 inch
Height from upper-edge of DIN-35 rail	52.4 mm / 2.063 inch

## Mechanical data

Design	horizontal
Type of mounting	DIN-35 rail
Marking level	Center/side marking

## Material Data



Color	gray
Insulating material	Polyamide 66 (PA 66)
Weight	17.396 g

## Commercial data

Country of origin	DE
GTIN	4055143408165
Customs Tariff No.	85369010000

## Approvals / Certificates

### Country specific Approvals

Logo	Approval	Certificate name
	CCA DEKRA Certification B.V.	71-102841
	CCA DEKRA Certification B.V.	NTR NL 7671
	CSA DEKRA Certification B.V.	2130762

















### UL-Approvals















Logo	Approval	Certificate name
	UL UL International Germany GmbH	E45172 sec.55







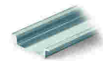









## Compatible products

















check

















	Item no.: 2000-510 TOPJOB®S L-type test plug module; modular; for jumper contact slot	<a href="http://www.wago.com/2000-510">www.wago.com/2000-510</a>
--	--	--

	<b>Item no.: 2000-552</b> Modular TOPJOB®S connector; modular; for jumper contact slot; 2-pole	<a href="http://www.wago.com/2000-552">www.wago.com/2000-552</a>
	<b>Item no.: 2000-553</b> Modular TOPJOB®S connector; modular; for jumper contact slot; 3-pole	<a href="http://www.wago.com/2000-553">www.wago.com/2000-553</a>
	<b>Item no.: 2000-554</b> Modular TOPJOB®S connector; modular; for jumper contact slot; 4-pole	<a href="http://www.wago.com/2000-554">www.wago.com/2000-554</a>
	<b>Item no.: 2000-555</b> Modular TOPJOB®S connector; modular; for jumper contact slot; 5-pole	<a href="http://www.wago.com/2000-555">www.wago.com/2000-555</a>
	<b>Item no.: 2000-556</b> Modular TOPJOB®S connector; modular; for jumper contact slot; 6-pole	<a href="http://www.wago.com/2000-556">www.wago.com/2000-556</a>
	<b>Item no.: 2000-557</b> Modular TOPJOB®S connector; modular; for jumper contact slot; 7-pole	<a href="http://www.wago.com/2000-557">www.wago.com/2000-557</a>
	<b>Item no.: 2000-558</b> Modular TOPJOB®S connector; modular; for jumper contact slot; 8-pole	<a href="http://www.wago.com/2000-558">www.wago.com/2000-558</a>
	<b>Item no.: 2000-559</b> Modular TOPJOB®S connector; modular; for jumper contact slot; 9-pole	<a href="http://www.wago.com/2000-559">www.wago.com/2000-559</a>
	<b>Item no.: 2000-560</b> Modular TOPJOB®S connector; modular; for jumper contact slot; 10-pole	<a href="http://www.wago.com/2000-560">www.wago.com/2000-560</a>
	<b>Item no.: 2009-174</b> Test plug adapter; for 4 mm Ø test plugs; for testing TOPJOB®S rail-mounted terminal blocks	<a href="http://www.wago.com/2009-174">www.wago.com/2009-174</a>
	<b>Item no.: 2009-182</b> Testing tap; for max. 2.5 mm <sup>2</sup> ; tool-free connection for individual test wires 0.08 - 2.5 mm	<a href="http://www.wago.com/2009-182">www.wago.com/2009-182</a>
	<b>Item no.: 210-136</b> Test plug; 2 mm Ø; with 500 mm cable	<a href="http://www.wago.com/210-136">www.wago.com/210-136</a>
	<b>Item no.: 210-137</b> Test plug; 2.3 mm Ø; with 500 mm cable	<a href="http://www.wago.com/210-137">www.wago.com/210-137</a>
<b>End plate</b>		
	<b>Item no.: 2000-5391</b> End and intermediate plate; 1 mm thick; for 3-conductor terminal blocks	<a href="http://www.wago.com/2000-5391">www.wago.com/2000-5391</a>
<b>Marking accessories</b>		
	<b>Item no.: 2009-110</b> Marking strips; on reel; not stretchable; plain; snap-on type	<a href="http://www.wago.com/2009-110">www.wago.com/2009-110</a>
	<b>Item no.: 2009-113</b> WMB-Inline; for smartPRINTER; on reel; plain; snap-on type	<a href="http://www.wago.com/2009-113">www.wago.com/2009-113</a>
	<b>Item no.: 2009-113/000-002</b> WMB-Inline; for smartPRINTER; on reel; plain; snap-on type	<a href="http://www.wago.com/2009-113/000-002">www.wago.com/2009-113/000-002</a>

	<b>Item no.: 2009-113/000-005</b> WMB-Inline; for smartPRINTER; on reel; plain; snap-on type	<a href="http://www.wago.com/2009-113/000-005">www.wago.com/2009-113/000-005</a>
	<b>Item no.: 2009-113/000-006</b> WMB-Inline; for smartPRINTER; on reel; plain; snap-on type	<a href="http://www.wago.com/2009-113/000-006">www.wago.com/2009-113/000-006</a>
	<b>Item no.: 2009-113/000-007</b> WMB-Inline; for smartPRINTER; on reel; plain; snap-on type	<a href="http://www.wago.com/2009-113/000-007">www.wago.com/2009-113/000-007</a>
	<b>Item no.: 2009-113/000-012</b> WMB-Inline; for smartPRINTER; on reel; plain; snap-on type	<a href="http://www.wago.com/2009-113/000-012">www.wago.com/2009-113/000-012</a>
	<b>Item no.: 2009-113/000-017</b> WMB-Inline; for smartPRINTER; on reel; plain; snap-on type	<a href="http://www.wago.com/2009-113/000-017">www.wago.com/2009-113/000-017</a>
	<b>Item no.: 2009-113/000-023</b> WMB-Inline; for smartPRINTER; on reel; plain; snap-on type	<a href="http://www.wago.com/2009-113/000-023">www.wago.com/2009-113/000-023</a>
	<b>Item no.: 2009-113/000-024</b> WMB-Inline; for smartPRINTER; on reel; plain; snap-on type	<a href="http://www.wago.com/2009-113/000-024">www.wago.com/2009-113/000-024</a>
	<b>Item no.: 2009-191</b> Group marker carrier	<a href="http://www.wago.com/2009-191">www.wago.com/2009-191</a>
	<b>Item no.: 793-3501</b> WMB marking card; as card; plain; snap-on type	<a href="http://www.wago.com/793-3501">www.wago.com/793-3501</a>
<b>tools</b>		
	<b>Item no.: 210-647</b> Operating tool with partially insulated shaft; Blade (2.5 x 0.4) mm; short	<a href="http://www.wago.com/210-647">www.wago.com/210-647</a>
	<b>Item no.: 210-648</b> Operating tool with partially insulated shaft; Blade (2.5 x 0.4) mm; short; angled	<a href="http://www.wago.com/210-648">www.wago.com/210-648</a>
	<b>Item no.: 210-719</b> Operating tool with partially insulated shaft; Type 1, blade (2.5 x 0.4) mm	<a href="http://www.wago.com/210-719">www.wago.com/210-719</a>
<b>Carrier rail</b>		
	<b>Item no.: 210-112</b> Steel carrier rail; 35 x 7.5 mm; 1 mm thick; 2 m long; slotted; according to EN 60715; "Hole width 25 mm	<a href="http://www.wago.com/210-112">www.wago.com/210-112</a>
	<b>Item no.: 210-113</b> Steel carrier rail; 35 x 7.5 mm; 1 mm thick; 2 m long; unslotted; according to EN 60715	<a href="http://www.wago.com/210-113">www.wago.com/210-113</a>
	<b>Item no.: 210-114</b> Steel carrier rail; 35 x 15 mm; 1.5 mm thick; 2 m long; unslotted; similar to EN 60715	<a href="http://www.wago.com/210-114">www.wago.com/210-114</a>
	<b>Item no.: 210-115</b> Steel carrier rail; 35 x 7.5 mm; 1 mm thick; 2 m long; slotted; according to EN 60715; "Hole width	<a href="http://www.wago.com/210-115">www.wago.com/210-115</a>

	18 mm	
	<b>Item no.: 210-118</b> Steel carrier rail; 35 x 15 mm; 2.3 mm thick; 2 m long; unslotted; according to EN 60715	<a href="http://www.wago.com/210-118">www.wago.com/210-118</a>
	<b>Item no.: 210-196</b> Aluminum carrier rail; 35 x 8.2 mm; 1.6 mm thick; 2 m long; unslotted; similar to EN 60715	<a href="http://www.wago.com/210-196">www.wago.com/210-196</a>
	<b>Item no.: 210-197</b> Steel carrier rail; 35 x 15 mm; 1.5 mm thick; 2 m long; slotted; similar to EN 60715	<a href="http://www.wago.com/210-197">www.wago.com/210-197</a>
	<b>Item no.: 210-198</b> Copper carrier rail; 35 x 15 mm; 2.3 mm thick; 2 m long; unslotted; according to EN 60715	<a href="http://www.wago.com/210-198">www.wago.com/210-198</a>
<b>General accessories</b>		
	<b>Item no.: 2000-121</b> Adaptor	<a href="http://www.wago.com/2000-121">www.wago.com/2000-121</a>
<b>Jumper</b>		
	<b>Item no.: 2000-402</b> Push-in type jumper bar; insulated; 2-way; Nominal current 14 A	<a href="http://www.wago.com/2000-402">www.wago.com/2000-402</a>
	<b>Item no.: 2000-402/000-005</b> Push-in type jumper bar; insulated; 2-way; Nominal current 14 A	<a href="http://www.wago.com/2000-402/000-005">www.wago.com/2000-402/000-005</a>
	<b>Item no.: 2000-402/000-006</b> Push-in type jumper bar; insulated; 2-way; Nominal current 14 A	<a href="http://www.wago.com/2000-402/000-006">www.wago.com/2000-402/000-006</a>
	<b>Item no.: 2000-402/000-018</b> Push-in type jumper bar; insulated; 2-way; Nominal current 14 A	<a href="http://www.wago.com/2000-402/000-018">www.wago.com/2000-402/000-018</a>
	<b>Item no.: 2000-403</b> Push-in type jumper bar; insulated; 3-way; Nominal current 14 A	<a href="http://www.wago.com/2000-403">www.wago.com/2000-403</a>
	<b>Item no.: 2000-403/000-005</b> Push-in type jumper bar; insulated; 3-way; Nominal current 14 A	<a href="http://www.wago.com/2000-403/000-005">www.wago.com/2000-403/000-005</a>
	<b>Item no.: 2000-403/000-006</b> Push-in type jumper bar; insulated; 3-way; Nominal current 14 A	<a href="http://www.wago.com/2000-403/000-006">www.wago.com/2000-403/000-006</a>
	<b>Item no.: 2000-404</b> Push-in type jumper bar; insulated; 4-way; Nominal current 14 A	<a href="http://www.wago.com/2000-404">www.wago.com/2000-404</a>
	<b>Item no.: 2000-404/000-005</b> Push-in type jumper bar; insulated; 4-way; Nominal current 14 A	<a href="http://www.wago.com/2000-404/000-005">www.wago.com/2000-404/000-005</a>
	<b>Item no.: 2000-404/000-006</b> Push-in type jumper bar; insulated; 4-way; Nominal current 14 A	<a href="http://www.wago.com/2000-404/000-006">www.wago.com/2000-404/000-006</a>

	<b>Item no.: 2000-405</b> Push-in type jumper bar; insulated; 5-way; Nominal current 14 A	<a href="http://www.wago.com/2000-405">www.wago.com/2000-405</a>
	<b>Item no.: 2000-405/000-005</b> Push-in type jumper bar; insulated; 5-way; Nominal current 14 A	<a href="http://www.wago.com/2000-405/000-005">www.wago.com/2000-405/000-005</a>
	<b>Item no.: 2000-405/000-006</b> Push-in type jumper bar; insulated; 5-way; Nominal current 14 A	<a href="http://www.wago.com/2000-405/000-006">www.wago.com/2000-405/000-006</a>
	<b>Item no.: 2000-405/011-000</b> Star point jumper; insulated; 3-way (1-3-5); IN = IN terminal block	<a href="http://www.wago.com/2000-405/011-000">www.wago.com/2000-405/011-000</a>
	<b>Item no.: 2000-406</b> Push-in type jumper bar; insulated; 6-way; Nominal current 14 A	<a href="http://www.wago.com/2000-406">www.wago.com/2000-406</a>
	<b>Item no.: 2000-406/000-005</b> Push-in type jumper bar; insulated; 6-way; Nominal current 14 A	<a href="http://www.wago.com/2000-406/000-005">www.wago.com/2000-406/000-005</a>
	<b>Item no.: 2000-406/000-006</b> Push-in type jumper bar; insulated; 6-way; Nominal current 14 A	<a href="http://www.wago.com/2000-406/000-006">www.wago.com/2000-406/000-006</a>
	<b>Item no.: 2000-406/020-000</b> Delta jumper; insulated; 1-2 3-4 5-6; IN = IN terminal block	<a href="http://www.wago.com/2000-406/020-000">www.wago.com/2000-406/020-000</a>
	<b>Item no.: 2000-407</b> Push-in type jumper bar; insulated; 7-way; Nominal current 14 A	<a href="http://www.wago.com/2000-407">www.wago.com/2000-407</a>
	<b>Item no.: 2000-407/000-005</b> Push-in type jumper bar; insulated; 7-way; Nominal current 14 A	<a href="http://www.wago.com/2000-407/000-005">www.wago.com/2000-407/000-005</a>
	<b>Item no.: 2000-407/000-006</b> Push-in type jumper bar; insulated; 7-way; Nominal current 14 A	<a href="http://www.wago.com/2000-407/000-006">www.wago.com/2000-407/000-006</a>
	<b>Item no.: 2000-408</b> Push-in type jumper bar; insulated; 8-way; Nominal current 14 A	<a href="http://www.wago.com/2000-408">www.wago.com/2000-408</a>
	<b>Item no.: 2000-408/000-005</b> Push-in type jumper bar; insulated; 8-way; Nominal current 14 A	<a href="http://www.wago.com/2000-408/000-005">www.wago.com/2000-408/000-005</a>
	<b>Item no.: 2000-408/000-006</b> Push-in type jumper bar; insulated; 8-way; Nominal current 14 A	<a href="http://www.wago.com/2000-408/000-006">www.wago.com/2000-408/000-006</a>
	<b>Item no.: 2000-409</b> Push-in type jumper bar; insulated; 9-way; Nominal current 14 A	<a href="http://www.wago.com/2000-409">www.wago.com/2000-409</a>
	<b>Item no.: 2000-409/000-005</b> Push-in type jumper bar; insulated; 9-way; Nominal current 14 A	<a href="http://www.wago.com/2000-409/000-005">www.wago.com/2000-409/000-005</a>

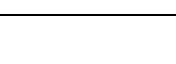
	<b>Item no.:</b> 2000-409/000-006 Push-in type jumper bar; insulated; 9-way; Nominal current 14 A	<a href="http://www.wago.com/2000-409/000-006">www.wago.com/2000-409/000-006</a>
	<b>Item no.:</b> 2000-410 Push-in type jumper bar; insulated; 10-way; Nominal current 14 A	<a href="http://www.wago.com/2000-410">www.wago.com/2000-410</a>
	<b>Item no.:</b> 2000-410/000-005 Push-in type jumper bar; insulated; 10-way; Nominal current 14 A	<a href="http://www.wago.com/2000-410/000-005">www.wago.com/2000-410/000-005</a>
	<b>Item no.:</b> 2000-410/000-006 Push-in type jumper bar; insulated; 10-way; Nominal current 14 A	<a href="http://www.wago.com/2000-410/000-006">www.wago.com/2000-410/000-006</a>
	<b>Item no.:</b> 2000-433 Push-in type jumper bar; insulated; from 1 to 3; Nominal current 14 A	<a href="http://www.wago.com/2000-433">www.wago.com/2000-433</a>
	<b>Item no.:</b> 2000-433/000-005 Push-in type jumper bar; insulated; from 1 to 3; Nominal current 14 A	<a href="http://www.wago.com/2000-433/000-005">www.wago.com/2000-433/000-005</a>
	<b>Item no.:</b> 2000-433/000-006 Push-in type jumper bar; insulated; from 1 to 3; Nominal current 14 A	<a href="http://www.wago.com/2000-433/000-006">www.wago.com/2000-433/000-006</a>
	<b>Item no.:</b> 2000-434 Push-in type jumper bar; insulated; from 1 to 4; Nominal current 14 A	<a href="http://www.wago.com/2000-434">www.wago.com/2000-434</a>
	<b>Item no.:</b> 2000-435 Push-in type jumper bar; insulated; from 1 to 5; Nominal current 14 A	<a href="http://www.wago.com/2000-435">www.wago.com/2000-435</a>
	<b>Item no.:</b> 2000-436 Push-in type jumper bar; insulated; from 1 to 6; Nominal current 14 A	<a href="http://www.wago.com/2000-436">www.wago.com/2000-436</a>
	<b>Item no.:</b> 2000-437 Push-in type jumper bar; insulated; from 1 to 7; Nominal current 14 A	<a href="http://www.wago.com/2000-437">www.wago.com/2000-437</a>
	<b>Item no.:</b> 2000-438 Push-in type jumper bar; insulated; from 1 to 8; Nominal current 14 A	<a href="http://www.wago.com/2000-438">www.wago.com/2000-438</a>
	<b>Item no.:</b> 2000-439 Push-in type jumper bar; insulated; from 1 to 9; Nominal current 14 A	<a href="http://www.wago.com/2000-439">www.wago.com/2000-439</a>
	<b>Item no.:</b> 2000-440 Push-in type jumper bar; insulated; from 1 to 10; Nominal current 14 A	<a href="http://www.wago.com/2000-440">www.wago.com/2000-440</a>
	<b>Item no.:</b> 2009-402 Push-in type wire jumper; insulated; wire length 60 mm; Conductor cross section 0.75 mm <sup>2</sup> ; suitable for 2000 and 2020 Series rail-mounted terminal blocks	<a href="http://www.wago.com/2009-402">www.wago.com/2009-402</a>
	<b>Item no.:</b> 2009-404 Push-in type wire jumper; insulated; wire length 110 mm; Conductor cross section 0.75 mm <sup>2</sup> ; suitable for 2000 and 2020 Series rail-mounted terminal blocks	<a href="http://www.wago.com/2009-404">www.wago.com/2009-404</a>
	<b>Item no.:</b> 2009-406 Push-in type wire jumper; insulated; wire length 250 mm; Conductor cross section 0.75 mm <sup>2</sup> ; suitable for 2000 and 2020 Series rail-mounted terminal blocks	<a href="http://www.wago.com/2009-406">www.wago.com/2009-406</a>
	<b>Item no.:</b> 210-103 Wire commoning chain; insulated; 50 connections	<a href="http://www.wago.com/210-103">www.wago.com/210-103</a>



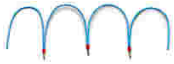

**Item no.: 210-123**  
Wire commoning chain; insulated; 50 connections

[www.wago.com/210-123](http://www.wago.com/210-123)

**ferrule**



**Item no.: 216-241**  
Ferrule; Sleeve for 0.5 mm<sup>2</sup> / AWG 22; insulated; electro-tin plated; electrolytic copper; gastight crimped; acc. to DIN 46228, Part 4/09.90 [www.wago.com/216-241](http://www.wago.com/216-241)



**Item no.: 216-242**  
Ferrule; Sleeve for 0.75 mm<sup>2</sup> / AWG 20; insulated; electro-tin plated; electrolytic copper; gastight crimped; acc. to DIN 46228, Part 4/09.90 [www.wago.com/216-242](http://www.wago.com/216-242)



**Item no.: 216-243**  
Ferrule; Sleeve for 1 mm<sup>2</sup> / AWG 18; insulated; electro-tin plated; electrolytic copper; gastight crimped; acc. to DIN 46228, Part 4/09.90 [www.wago.com/216-243](http://www.wago.com/216-243)

**Protective Warning Marker**



**Item no.: 2000-115**  
Protective warning marker; with high-voltage symbol, black; for 5 terminal blocks

[www.wago.com/2000-115](http://www.wago.com/2000-115)

**Downloads**

**Documentation**

**Bid Text**

2000-5317/102-000	Aug 13, 2018	DOCX 15.4 kB	Download
-------------------	--------------	-----------------	----------

**smartDATA**

**CAD data**

3D Download 2000-5317/102-000	URL	Download
-------------------------------	-----	----------

Subject to changes.