

Data sheet | Item number: 2002-2408

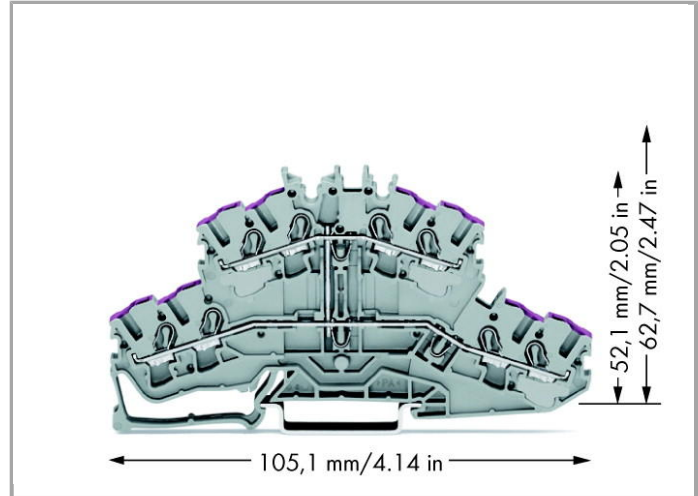

4-conductor double deck terminal block; 8-conductor through terminal block; L; without marker carrier; internal commoning; conductor entry with violet marking; for DIN-rail 35 x 15 and 35 x 7.5; 2.5 mm²; Push-in CAGE CLAMP®

www.wago.com/2002-2408

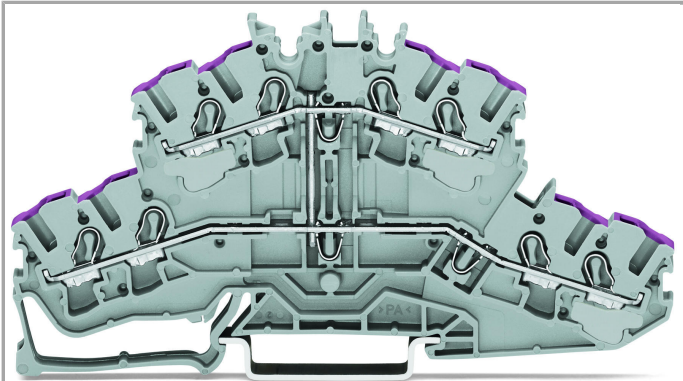

RoHS
Compliant ✓

BOMcheck.net

Color: ■

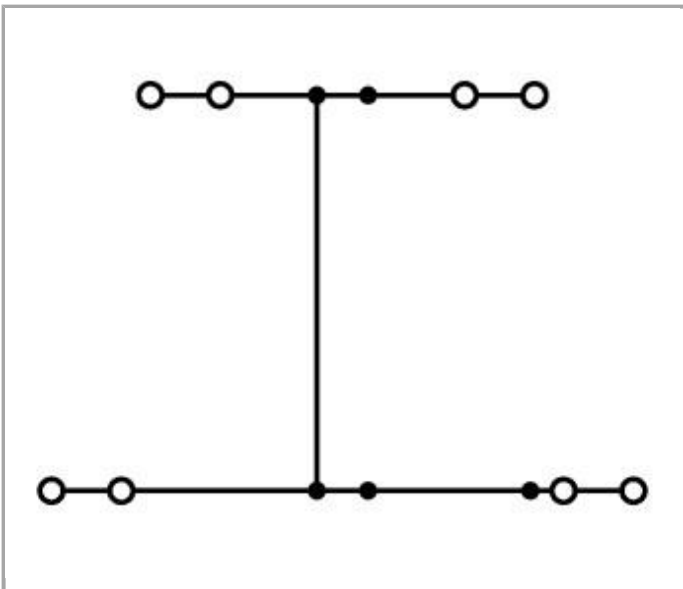

Data

Electrical data

Ratings per IEC/EN 60664-1

Rated voltage (III / 3)	800 V
Rated impulse voltage (III / 3)	8 kV
Rated current	24 A



Rated current (2)	28 A
Legend (ratings)	(III / 3) \triangleq Overvoltage category III / Pollution degree 3

Approvals per UL 1059

Rated voltage UL (Use Group B)	600 V
Rated current UL (Use Group B)	20 A
Rated voltage UL (Use Group C)	600 V
Rated current UL (Use Group C)	20 A

Connection data

Connection technology	Push-in CAGE CLAMP [®]
Actuation type	Push-in Operating tool
Connectable conductor materials	Copper
Nominal cross section	2.5 mm ²
Solid conductor	0.25 ... 4 mm ² / 22 ... 12 AWG
Solid conductor, push-in termination	0.75 ... 4 mm ² / 18 ... 12 AWG
Fine-stranded conductor	0.25 ... 4 mm ² / 22 ... 12 AWG
Fine-stranded conductor with ferrule, push-in termination, from	0.75 mm ² / 18 AWG
Strip length	10 ... 12 mm / 0.39 ... 0.47 Inch
Total number of connection points	8
Total number of potentials	1
Number of levels	2
Type of wiring	Front-entry wiring

Geometrical Data

Width	5.2 mm / 0.205 inch
Height from upper-edge of DIN-35 rail	52.1 mm / 2.051 inch
Depth	105.1 mm / 4.138 inch

Mechanical data

Design	horizontal
Type of mounting	DIN-35 rail
Potential marking	L
Marking level	Center/side marking

Material Data

Color	gray
Insulating material	Polyamide 66 (PA 66)
Fire load	0.294 MJ

Weight	16.142 g
--------	----------

Commercial data

Country of origin	CN
GTIN	4050821145011
Customs Tariff No.	85369010000
Product Group	22 (TOPJOB S)

Approvals / Certificates

Ex-Approvals

Logo	Approval	Certificate name
	IECEX Physikalisch Technische Bundesanstalt	IECEX PTB 03.0004U

Country specific Approvals

Logo	Approval	Certificate name
	CCA DEKRA Certification B.V.	NTR NL 7585



CSA DEKRA Certification B.V.	1536069
---------------------------------	---------



CSA DEKRA Certification B.V.	1536069
---------------------------------	---------



KEMA/KEUR DEKRA Certification B.V.	2198985.01
---------------------------------------	------------

Ship Approvals

Logo	Approval	Certificate name
	ABS American Bureau of Shipping	14-HG1293677-PDA



BV Bureau Veritas S.A.	38586/A0 BV
---------------------------	-------------



DNV GL
Det Norske Veritas, Germanischer Lloyd













TAE00001V2

UL-Approvals

Logo	Approval	Certificate name
	cURus Underwriters Laboratories Inc.	E45172





Compatible products

Carrier rail

	Item no.: 210-112 Steel carrier rail; 35 x 7.5 mm; 1 mm thick; 2 m long; slotted; according to EN 60715; "Hole width 25 mm	www.wago.com/210-112
	Item no.: 210-113 Steel carrier rail; 35 x 7.5 mm; 1 mm thick; 2 m long; unslotted; according to EN 60715	www.wago.com/210-113
	Item no.: 210-114 Steel carrier rail; 35 x 15 mm; 1.5 mm thick; 2 m long; unslotted; similar to EN 60715	www.wago.com/210-114
	Item no.: 210-115 Steel carrier rail; 35 x 7.5 mm; 1 mm thick; 2 m long; slotted; according to EN 60715; "Hole width 18 mm	www.wago.com/210-115
	Item no.: 210-118 Steel carrier rail; 35 x 15 mm; 2.3 mm thick; 2 m long; unslotted; according to EN 60715	www.wago.com/210-118
	Item no.: 210-196 Aluminum carrier rail; 35 x 8.2 mm; 1.6 mm thick; 2 m long; unslotted; similar to EN 60715	www.wago.com/210-196
	Item no.: 210-197 Steel carrier rail; 35 x 15 mm; 1.5 mm thick; 2 m long; slotted; similar to EN 60715	www.wago.com/210-197
	Item no.: 210-198 Copper carrier rail; 35 x 15 mm; 2.3 mm thick; 2 m long; unslotted; according to EN 60715	www.wago.com/210-198
	Item no.: 210-504 Steel carrier rail; 35 x 7.5 mm; 1 mm thick; 2 m long; slotted; galvanized; according to EN 60715	www.wago.com/210-504
	Item no.: 210-505 Steel carrier rail; 35 x 7.5 mm; 1 mm thick; 2 m long; unslotted; galvanized; according to EN 60715	www.wago.com/210-505
	Item no.: 210-506 Steel carrier rail; 35 x 15 mm; 1.5 mm thick; 2 m long; unslotted; galvanized; similar to EN 60715	www.wago.com/210-506
	Item no.: 210-508 Steel carrier rail; 35 x 15 mm; 1.5 mm thick; 2 m long; slotted; galvanized; similar to EN 60715	www.wago.com/210-508

check









Item no.: 2002-611

	TOPJOB®S L-type test plug module; modular; 1-pole	www.wago.com/2002-611
	Item no.: 2002-649 TOPJOB®S L-type spacer module; modular; e.g., for bridging commoned terminal blocks	www.wago.com/2002-649
	Item no.: 2009-174 Test plug adapter; for 4 mm Ø test plugs; for testing TOPJOB®S rail-mounted terminal blocks	www.wago.com/2009-174
	Item no.: 2009-182 Testing tap; for max. 2.5 mm ² ; tool-free connection for individual test wires 0.08 - 2.5 mm	www.wago.com/2009-182

End plate

	Item no.: 2002-2491 End and intermediate plate; 0.8 mm thick	www.wago.com/2002-2491
	Item no.: 2002-2492 End and intermediate plate; 0.8 mm thick	www.wago.com/2002-2492

ferrule

	Item no.: 216-241 Ferrule; Sleeve for 0.5 mm ² / AWG 22; insulated; electro-tin plated; electrolytic copper; gastight crimped; acc. to DIN 46228, Part 4/09.90	www.wago.com/216-241
	Item no.: 216-242 Ferrule; Sleeve for 0.75 mm ² / AWG 20; insulated; electro-tin plated; electrolytic copper; gastight crimped; acc. to DIN 46228, Part 4/09.90	www.wago.com/216-242
	Item no.: 216-243 Ferrule; Sleeve for 1 mm ² / AWG 18; insulated; electro-tin plated; electrolytic copper; gastight crimped; acc. to DIN 46228, Part 4/09.90	www.wago.com/216-243
	Item no.: 216-244 Ferrule; Sleeve for 1.5 mm ² / AWG 16; insulated; electro-tin plated; electrolytic copper; gastight crimped; acc. to DIN 46228, Part 4/09.90	www.wago.com/216-244
	Item no.: 216-246 Ferrule; Sleeve for 2.5 mm ² / AWG 14; insulated; electro-tin plated; electrolytic copper; gastight crimped; acc. to DIN 46228, Part 4/09.90	www.wago.com/216-246
	Item no.: 216-262 Ferrule; Sleeve for 0.75 mm ² / AWG 20; insulated; electro-tin plated; electrolytic copper; gastight crimped; acc. to DIN 46228, Part 4/09.90	www.wago.com/216-262
	Item no.: 216-263 Ferrule; Sleeve for 1 mm ² / AWG 18; insulated; electro-tin plated; electrolytic copper; gastight crimped; acc. to DIN 46228, Part 4/09.90	www.wago.com/216-263
	Item no.: 216-264 Ferrule; Sleeve for 1.5 mm ² / AWG 16; insulated; electro-tin plated; electrolytic copper; gastight crimped; acc. to DIN 46228, Part 4/09.90	www.wago.com/216-264
	Item no.: 216-266 Ferrule; Sleeve for 2.5 mm ² / AWG 14; insulated; electro-tin plated; electrolytic copper; gastight crimped; acc. to DIN 46228, Part 4/09.90	www.wago.com/216-266













General accessories

















	Item no.: 2002-121 Adaptor	www.wago.com/2002-121
--	--------------------------------------	--



















Insulation stop

















	Item no.: 2002-171 Insulation stop; 0.25 - 0.5 mm²; 5 pieces/strip	www.wago.com/2002-171
	Item no.: 2002-172 Insulation stop; 0.75 - 1 mm²; 5 pieces/strip	www.wago.com/2002-172















Jumper

















	Item no.: 2002-400 Adjacent jumper for continuous commoning; insulated; 2-way; Nominal current 25 A	www.wago.com/2002-400
	Item no.: 2002-402 Push-in type jumper bar; insulated; 2-way; Nominal current 25 A	www.wago.com/2002-402
	Item no.: 2002-402/000-005 Push-in type jumper bar; insulated; 2-way; Nominal current 25 A	www.wago.com/2002-402/000-005
	Item no.: 2002-402/000-006 Push-in type jumper bar; insulated; 2-way; Nominal current 25 A	www.wago.com/2002-402/000-006
	Item no.: 2002-403 Push-in type jumper bar; insulated; 3-way; Nominal current 25 A	www.wago.com/2002-403
	Item no.: 2002-403/000-005 Push-in type jumper bar; insulated; 3-way; Nominal current 25 A	www.wago.com/2002-403/000-005
	Item no.: 2002-403/000-006 Push-in type jumper bar; insulated; 3-way; Nominal current 25 A	www.wago.com/2002-403/000-006
	Item no.: 2002-404 Push-in type jumper bar; insulated; 4-way; Nominal current 25 A	www.wago.com/2002-404
	Item no.: 2002-404/000-005 Push-in type jumper bar; insulated; 4-way; Nominal current 25 A	www.wago.com/2002-404/000-005
	Item no.: 2002-404/000-006 Push-in type jumper bar; insulated; 4-way; Nominal current 25 A	www.wago.com/2002-404/000-006
	Item no.: 2002-405 Push-in type jumper bar; insulated; 5-way; Nominal current 25 A	www.wago.com/2002-405
	Item no.: 2002-405/000-005 Push-in type jumper bar; insulated; 5-way; Nominal current 25 A	www.wago.com/2002-405/000-005
	Item no.: 2002-405/000-006 Push-in type jumper bar; insulated; 5-way; Nominal current 25 A	www.wago.com/2002-405/000-006

	Item no.: 2002-405/011-000 Star point jumper; insulated; 3-way (1-3-5); IN = IN terminal block	www.wago.com/2002-405/011-000
	Item no.: 2002-406 Push-in type jumper bar; insulated; 6-way; Nominal current 25 A	www.wago.com/2002-406
	Item no.: 2002-406/000-005 Push-in type jumper bar; insulated; 6-way; Nominal current 25 A	www.wago.com/2002-406/000-005
	Item no.: 2002-406/000-006 Push-in type jumper bar; insulated; 6-way; Nominal current 25 A	www.wago.com/2002-406/000-006
	Item no.: 2002-406/020-000 Delta jumper; insulated; 1-2 3-4 5-6; IN = IN terminal block	www.wago.com/2002-406/020-000
	Item no.: 2002-407 Push-in type jumper bar; insulated; 7-way; Nominal current 25 A	www.wago.com/2002-407
	Item no.: 2002-407/000-005 Push-in type jumper bar; insulated; 7-way; Nominal current 25 A	www.wago.com/2002-407/000-005
	Item no.: 2002-407/000-006 Push-in type jumper bar; insulated; 7-way; Nominal current 25 A	www.wago.com/2002-407/000-006
	Item no.: 2002-408 Push-in type jumper bar; insulated; 8-way; Nominal current 25 A	www.wago.com/2002-408
	Item no.: 2002-408/000-005 Push-in type jumper bar; insulated; 8-way; Nominal current 25 A	www.wago.com/2002-408/000-005
	Item no.: 2002-408/000-006 Push-in type jumper bar; insulated; 8-way; Nominal current 25 A	www.wago.com/2002-408/000-006
	Item no.: 2002-409 Push-in type jumper bar; insulated; 9-way; Nominal current 25 A	www.wago.com/2002-409
	Item no.: 2002-409/000-005 Push-in type jumper bar; insulated; 9-way; Nominal current 25 A	www.wago.com/2002-409/000-005
	Item no.: 2002-409/000-006 Push-in type jumper bar; insulated; 9-way; Nominal current 25 A	www.wago.com/2002-409/000-006
	Item no.: 2002-410 Push-in type jumper bar; insulated; 10-way; Nominal current 25 A	www.wago.com/2002-410
	Item no.: 2002-410/000-005 Push-in type jumper bar; insulated; 10-way; Nominal current 25 A	www.wago.com/2002-410/000-005

	Item no.: 2002-410/000-006 Push-in type jumper bar; insulated; 10-way; Nominal current 25 A	www.wago.com/2002-410/000-006
	Item no.: 2002-423 Push-in type jumper bar; insulated; from 1 to 3; Nominal current 25 A	www.wago.com/2002-423
	Item no.: 2002-423/000-005 Adjacent jumper for continuous commoning; insulated; from 1 to 3; Nominal current 25 A	www.wago.com/2002-423/000-005
	Item no.: 2002-423/000-006 Adjacent jumper for continuous commoning; insulated; from 1 to 3; Nominal current 25 A	www.wago.com/2002-423/000-006
	Item no.: 2002-433 Push-in type jumper bar; insulated; from 1 to 3; Nominal current 25 A	www.wago.com/2002-433
	Item no.: 2002-434 Push-in type jumper bar; insulated; from 1 to 4; Nominal current 25 A	www.wago.com/2002-434
	Item no.: 2002-435 Push-in type jumper bar; insulated; from 1 to 5; Nominal current 25 A	www.wago.com/2002-435
	Item no.: 2002-436 Push-in type jumper bar; insulated; from 1 to 6; Nominal current 25 A	www.wago.com/2002-436
	Item no.: 2002-437 Push-in type jumper bar; insulated; from 1 to 7; Nominal current 25 A	www.wago.com/2002-437
	Item no.: 2002-438 Push-in type jumper bar; insulated; from 1 to 8; Nominal current 25 A	www.wago.com/2002-438
	Item no.: 2002-439 Push-in type jumper bar; insulated; from 1 to 9; Nominal current 25 A	www.wago.com/2002-439
	Item no.: 2002-440 Push-in type jumper bar; insulated; from 1 to 10; Nominal current 25 A	www.wago.com/2002-440
	Item no.: 2002-472 Staggered jumper; insulated; 2-way; Nominal current 25 A; suitable for 2002 and 2003 Series rail-mounted terminal blocks	www.wago.com/2002-472
	Item no.: 2002-473 Staggered jumper; insulated; 3-way; Nominal current 25 A; suitable for 2002 and 2003 Series rail-mounted terminal blocks	www.wago.com/2002-473
	Item no.: 2002-474 Staggered jumper; insulated; 4-way; Nominal current 25 A; suitable for 2002 and 2003 Series rail-mounted terminal blocks	www.wago.com/2002-474
	Item no.: 2002-475 Staggered jumper; insulated; 5-way; Nominal current 25 A; suitable for 2002 and 2003 Series rail-mounted terminal blocks	www.wago.com/2002-475
	Item no.: 2002-476 Staggered jumper; insulated; 6-way; Nominal current 25 A; suitable for 2002 and 2003 Series rail-mounted terminal blocks	www.wago.com/2002-476
	Item no.: 2002-477 Staggered jumper; insulated; 7-way; Nominal current 25 A; suitable for 2002 and 2003 Series rail-mounted terminal blocks	www.wago.com/2002-477

	Item no.: 2002-478 Staggered jumper; insulated; 8-way; Nominal current 25 A; suitable for 2002 and 2003 Series rail-mounted terminal blocks	www.wago.com/2002-478
	Item no.: 2002-479 Staggered jumper; insulated; 9-way; Nominal current 25 A; suitable for 2002 and 2003 Series rail-mounted terminal blocks	www.wago.com/2002-479
	Item no.: 2002-480 Staggered jumper; insulated; 10-way; Nominal current 25 A; suitable for 2002 and 2003 Series rail-mounted terminal blocks	www.wago.com/2002-480
	Item no.: 2002-481 Staggered jumper; insulated; 11-way; Nominal current 25 A; suitable for 2002 and 2003 Series rail-mounted terminal blocks	www.wago.com/2002-481
	Item no.: 2002-482 Staggered jumper; insulated; 12-way; Nominal current 25 A; suitable for 2002 and 2003 Series rail-mounted terminal blocks	www.wago.com/2002-482
	Item no.: 2002-492 Double-deck vertical jumper; insulated	www.wago.com/2002-492
	Item no.: 2002-492/000-012 Double-deck vertical jumper; insulated	www.wago.com/2002-492/000-012
	Item no.: 2009-412 Push-in type wire jumper; insulated; wire length 60 mm; Conductor cross section 1.5 mm ² ; suitable for 2001, 2002, 2003 and 2022 Series rail-mounted terminal blocks	www.wago.com/2009-412
	Item no.: 2009-414 Push-in type wire jumper; insulated; wire length 110 mm; Conductor cross section 1.5 mm ² ; suitable for 2001, 2002, 2003 and 2022 Series rail-mounted terminal blocks	www.wago.com/2009-414
	Item no.: 2009-416 Push-in type wire jumper; insulated; wire length 250 mm; Conductor cross section 1.5 mm ² ; suitable for 2001, 2002, 2003 and 2022 Series rail-mounted terminal blocks	www.wago.com/2009-416
	Item no.: 210-103 Wire commoning chain; insulated; 50 connections	www.wago.com/210-103
	Item no.: 210-123 Wire commoning chain; insulated; 50 connections	www.wago.com/210-123
Protective Warning Marker		
	Item no.: 2002-115 Protective warning marker; with high-voltage symbol, black; for 5 terminal blocks	www.wago.com/2002-115
Marking accessories		
	Item no.: 2002-161 Adaptor	www.wago.com/2002-161
	Item no.: 2009-110 Marking strips; on reel; not stretchable; plain; snap-on type	www.wago.com/2009-110
	Item no.: 2009-115 WMB-Inline; for smartPRINTER; on reel; stretchable 5 - 5.2 mm; plain; snap-on type	www.wago.com/2009-115

	<p>Item no.: 2009-115/000-002 WMB-Inline; for smartPRINTER; on reel; stretchable 5 - 5.2 mm; plain; snap-on type</p>	www.wago.com/2009-115/000-002
	<p>Item no.: 2009-115/000-006 WMB-Inline; for smartPRINTER; on reel; stretchable 5 - 5.2 mm; plain; snap-on type</p>	www.wago.com/2009-115/000-006
	<p>Item no.: 2009-115/000-007 WMB-Inline; for smartPRINTER; on reel; stretchable 5 - 5.2 mm; plain; snap-on type</p>	www.wago.com/2009-115/000-007
	<p>Item no.: 2009-115/000-012 WMB-Inline; for smartPRINTER; on reel; stretchable 5 - 5.2 mm; plain; snap-on type</p>	www.wago.com/2009-115/000-012
	<p>Item no.: 2009-115/000-017 WMB-Inline; for smartPRINTER; on reel; stretchable 5 - 5.2 mm; plain; snap-on type</p>	www.wago.com/2009-115/000-017
	<p>Item no.: 2009-115/000-023 WMB-Inline; for smartPRINTER; on reel; stretchable 5 - 5.2 mm; plain; snap-on type</p>	www.wago.com/2009-115/000-023
	<p>Item no.: 2009-115/000-024 WMB-Inline; for smartPRINTER; on reel; stretchable 5 - 5.2 mm; plain; snap-on type</p>	www.wago.com/2009-115/000-024
	<p>Item no.: 2009-145 Mini-WSB Inline; for smartPRINTER; on reel; stretchable 5 - 5.2 mm; plain; snap-on type</p>	www.wago.com/2009-145
	<p>Item no.: 2009-145/000-002 Mini-WSB Inline; for smartPRINTER; on reel; stretchable 5 - 5.2 mm; plain; snap-on type</p>	www.wago.com/2009-145/000-002
	<p>Item no.: 2009-145/000-005 Mini-WSB Inline; for smartPRINTER; on reel; stretchable 5 - 5.2 mm; plain; snap-on type</p>	www.wago.com/2009-145/000-005
	<p>Item no.: 2009-145/000-006 Mini-WSB Inline; for smartPRINTER; on reel; stretchable 5 - 5.2 mm; plain; snap-on type</p>	www.wago.com/2009-145/000-006
	<p>Item no.: 2009-145/000-007 Mini-WSB Inline; for smartPRINTER; on reel; stretchable 5 - 5.2 mm; plain; snap-on type</p>	www.wago.com/2009-145/000-007
	<p>Item no.: 2009-145/000-012 Mini-WSB Inline; for smartPRINTER; on reel; stretchable 5 - 5.2 mm; plain; snap-on type</p>	www.wago.com/2009-145/000-012
	<p>Item no.: 2009-145/000-023 Mini-WSB Inline; for smartPRINTER; on reel; stretchable 5 - 5.2 mm; plain; snap-on type</p>	www.wago.com/2009-145/000-023
	<p>Item no.: 2009-145/000-024 Mini-WSB Inline; on reel; stretchable 5 - 5.2 mm; plain; snap-on type</p>	www.wago.com/2009-145/000-024

	Item no.: 2009-191 Group marker carrier	www.wago.com/2009-191
	Item no.: 2009-192 Group marker carrier	www.wago.com/2009-192
	Item no.: 2009-193 Group marker carrier	www.wago.com/2009-193
	Item no.: 2009-198 Adaptor	www.wago.com/2009-198
	Item no.: 248-501 Miniature WSB Quick marking system; plain; Marker width 5 mm; 10 strips with 10 markers per card	www.wago.com/248-501
	Item no.: 248-501/000-002 Mini-WSB marking card; as card; not stretchable; plain; snap-on type	www.wago.com/248-501/000-002
	Item no.: 248-501/000-005 Mini-WSB marking card; as card; plain; snap-on type	www.wago.com/248-501/000-005
	Item no.: 248-501/000-006 Mini-WSB marking card; as card; not stretchable; plain; snap-on type	www.wago.com/248-501/000-006
	Item no.: 248-501/000-007 Mini-WSB marking card; as card; not stretchable; plain; snap-on type	www.wago.com/248-501/000-007
	Item no.: 248-501/000-012 Mini-WSB marking card; as card; not stretchable; plain; snap-on type	www.wago.com/248-501/000-012
	Item no.: 248-501/000-017 Mini-WSB marking card; as card; not stretchable; plain; snap-on type	www.wago.com/248-501/000-017
	Item no.: 248-501/000-023 Mini-WSB marking card; as card; not stretchable; plain; snap-on type	www.wago.com/248-501/000-023
	Item no.: 248-501/000-024 Mini-WSB marking card; as card; not stretchable; plain; snap-on type	www.wago.com/248-501/000-024
	Item no.: 793-501 WMB marking card; as card; not stretchable; plain; snap-on type	www.wago.com/793-501
	Item no.: 793-501/000-002 WMB marking card; as card; not stretchable; plain; snap-on type	www.wago.com/793-501/000-002
	Item no.: 793-501/000-005 WMB marking card; as card; not stretchable; plain; snap-on type	www.wago.com/793-501/000-005



Item no.: 793-501/000-006
WMB marking card; as card; not stretchable; plain; snap-on type

www.wago.com/793-501/000-006



Item no.: 793-501/000-007
WMB marking card; as card; not stretchable; plain; snap-on type

www.wago.com/793-501/000-007



Item no.: 793-501/000-012
WMB marking card; as card; not stretchable; plain; snap-on type

www.wago.com/793-501/000-012



Item no.: 793-501/000-017
WMB marking card; as card; not stretchable; plain; snap-on type

www.wago.com/793-501/000-017



Item no.: 793-501/000-023
WMB marking card; as card; not stretchable; plain; snap-on type

www.wago.com/793-501/000-023



Item no.: 793-501/000-024
WMB marking card; as card; not stretchable; plain; snap-on type

www.wago.com/793-501/000-024



Item no.: 793-5501
WMB marking card; as card; for terminal block width 5 - 17.5 mm; stretchable 5 - 5.2 mm; plain; snap-on type

www.wago.com/793-5501



Item no.: 793-5501/000-002
WMB marking card; as card; for terminal block width 5 - 17.5 mm; stretchable 5 - 5.2 mm; plain; snap-on type

www.wago.com/793-5501/000-002



Item no.: 793-5501/000-005
WMB marking card; as card; stretchable 5 - 5.2 mm; plain; snap-on type

www.wago.com/793-5501/000-005



Item no.: 793-5501/000-006
WMB marking card; as card; stretchable 5 - 5.2 mm; plain; snap-on type

www.wago.com/793-5501/000-006



Item no.: 793-5501/000-007
WMB marking card; as card; stretchable 5 - 5.2 mm; plain; snap-on type

www.wago.com/793-5501/000-007



Item no.: 793-5501/000-012
WMB marking card; as card; stretchable 5 - 5.2 mm; plain; snap-on type

www.wago.com/793-5501/000-012



Item no.: 793-5501/000-017
WMB marking card; as card; stretchable 5 - 5.2 mm; plain; snap-on type

www.wago.com/793-5501/000-017



Item no.: 793-5501/000-023
WMB marking card; as card; stretchable 5 - 5.2 mm; plain; snap-on type

www.wago.com/793-5501/000-023



Item no.: 793-5501/000-024
WMB marking card; as card; stretchable 5 - 5.2 mm; plain; snap-on type

www.wago.com/793-5501/000-024

tools



Item no.: 210-658

Operating tool with partially insulated shaft; Blade (3.5 x 0.5) mm; short; angled

www.wago.com/210-658



Item no.: 210-720

Operating tool with partially insulated shaft; Type 2, blade (3.5 x 0.5) mm

www.wago.com/210-720

Downloads

Documentation

Bid Text

2002-2408

Aug 13, 2018

DOCX
15.3 kB

Download

smartDATA

CAD data

3D Download 2002-2408

URL

Download

Product family

TOPJOB® S

TOPJOB® S: In various industrial applications and modern building installations, WAGO's wide and versatile range of rail-mount terminal blocks provides more than just reliable electrical connections.

[Learn more about the product family.](#)

[Show all products from the family](#)

Subject to changes.

WAGO Kontakttechnik GmbH & Co. KG

Hansastr. 27

32423 Minden

Phone: +49571 887-0 | Fax: +49571 887-169

Email: info.de@wago.com | Web: www.wago.com

Do you have any questions about our products?

We are always happy to take your call at +49 (571) 887-44222.