

Data sheet | Item number: 2002-820

Empty component plug housing; 10.4 mm wide; 4-pole; Type 3

[www.wago.com/2002-820](http://www.wago.com/2002-820)

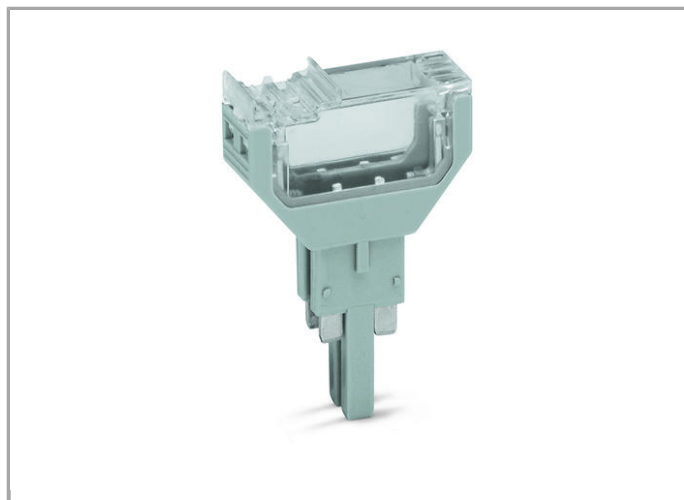
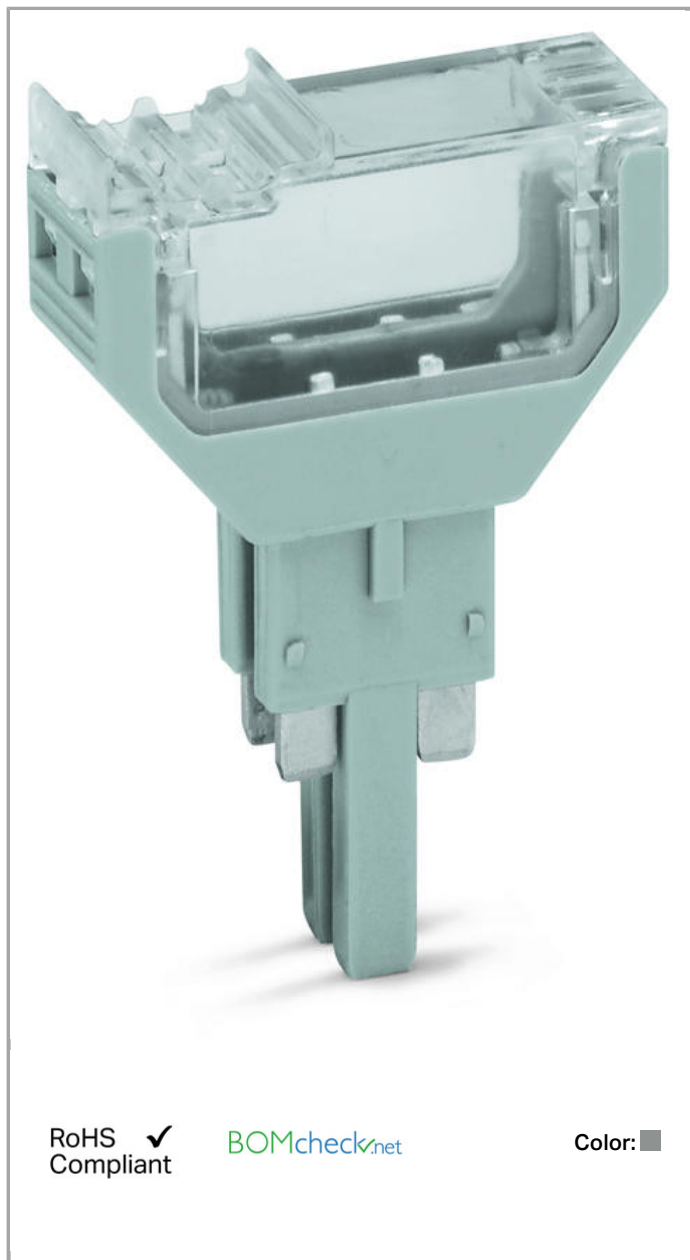

RoHS  Compliant

[BOMcheck.net](https://www.bomcheck.net)

Color: ■

## Data

### Geometrical Data

Width	10.4 mm / 0.409 inch
Plug width	10.4 mm / 0.409 inch

## Mechanical data

Marking level	Center marking
---------------	----------------

## Material Data









Color	gray
Fire load	0.09 MJ
Weight	5.3 g















## Commercial data

Country of origin	DE
GTIN	4045454857783
Customs Tariff No.	85472000900
Product Group	22 (TOPJOB S)

## Compatible products

### Marking accessories

	<b>Item no.: 2009-110</b> Marking strips; on reel; not stretchable; plain; snap-on type	<a href="http://www.wago.com/2009-110">www.wago.com/2009-110</a>
	<b>Item no.: 2009-115</b> WMB-Inline; for smartPRINTER; on reel; stretchable 5 - 5.2 mm; plain; snap-on type	<a href="http://www.wago.com/2009-115">www.wago.com/2009-115</a>
	<b>Item no.: 2009-115/000-002</b> WMB-Inline; for smartPRINTER; on reel; stretchable 5 - 5.2 mm; plain; snap-on type	<a href="http://www.wago.com/2009-115/000-002">www.wago.com/2009-115/000-002</a>
	<b>Item no.: 2009-115/000-006</b> WMB-Inline; for smartPRINTER; on reel; stretchable 5 - 5.2 mm; plain; snap-on type	<a href="http://www.wago.com/2009-115/000-006">www.wago.com/2009-115/000-006</a>
	<b>Item no.: 2009-115/000-007</b> WMB-Inline; for smartPRINTER; on reel; stretchable 5 - 5.2 mm; plain; snap-on type	<a href="http://www.wago.com/2009-115/000-007">www.wago.com/2009-115/000-007</a>
	<b>Item no.: 2009-115/000-012</b> WMB-Inline; for smartPRINTER; on reel; stretchable 5 - 5.2 mm; plain; snap-on type	<a href="http://www.wago.com/2009-115/000-012">www.wago.com/2009-115/000-012</a>
	<b>Item no.: 2009-115/000-017</b> WMB-Inline; for smartPRINTER; on reel; stretchable 5 - 5.2 mm; plain; snap-on type	<a href="http://www.wago.com/2009-115/000-017">www.wago.com/2009-115/000-017</a>
	<b>Item no.: 2009-115/000-023</b> WMB-Inline; for smartPRINTER; on reel; stretchable 5 - 5.2 mm; plain; snap-on type	<a href="http://www.wago.com/2009-115/000-023">www.wago.com/2009-115/000-023</a>
	<b>Item no.: 2009-115/000-024</b> WMB-Inline; for smartPRINTER; on reel; stretchable 5 - 5.2 mm; plain; snap-on type	<a href="http://www.wago.com/2009-115/000-024">www.wago.com/2009-115/000-024</a>

	<b>Item no.: 793-501</b> WMB marking card; as card; not stretchable; plain; snap-on type	<a href="http://www.wago.com/793-501">www.wago.com/793-501</a>
	<b>Item no.: 793-501/000-002</b> WMB marking card; as card; not stretchable; plain; snap-on type	<a href="http://www.wago.com/793-501/000-002">www.wago.com/793-501/000-002</a>
	<b>Item no.: 793-501/000-005</b> WMB marking card; as card; not stretchable; plain; snap-on type	<a href="http://www.wago.com/793-501/000-005">www.wago.com/793-501/000-005</a>
	<b>Item no.: 793-501/000-006</b> WMB marking card; as card; not stretchable; plain; snap-on type	<a href="http://www.wago.com/793-501/000-006">www.wago.com/793-501/000-006</a>
	<b>Item no.: 793-501/000-007</b> WMB marking card; as card; not stretchable; plain; snap-on type	<a href="http://www.wago.com/793-501/000-007">www.wago.com/793-501/000-007</a>
	<b>Item no.: 793-501/000-012</b> WMB marking card; as card; not stretchable; plain; snap-on type	<a href="http://www.wago.com/793-501/000-012">www.wago.com/793-501/000-012</a>
	<b>Item no.: 793-501/000-017</b> WMB marking card; as card; not stretchable; plain; snap-on type	<a href="http://www.wago.com/793-501/000-017">www.wago.com/793-501/000-017</a>
	<b>Item no.: 793-501/000-023</b> WMB marking card; as card; not stretchable; plain; snap-on type	<a href="http://www.wago.com/793-501/000-023">www.wago.com/793-501/000-023</a>
	<b>Item no.: 793-501/000-024</b> WMB marking card; as card; not stretchable; plain; snap-on type	<a href="http://www.wago.com/793-501/000-024">www.wago.com/793-501/000-024</a>
	<b>Item no.: 793-5501</b> WMB marking card; as card; for terminal block width 5 - 17.5 mm; stretchable 5 - 5.2 mm; plain; snap-on type	<a href="http://www.wago.com/793-5501">www.wago.com/793-5501</a>
	<b>Item no.: 793-5501/000-002</b> WMB marking card; as card; for terminal block width 5 - 17.5 mm; stretchable 5 - 5.2 mm; plain; snap-on type	<a href="http://www.wago.com/793-5501/000-002">www.wago.com/793-5501/000-002</a>
	<b>Item no.: 793-5501/000-005</b> WMB marking card; as card; stretchable 5 - 5.2 mm; plain; snap-on type	<a href="http://www.wago.com/793-5501/000-005">www.wago.com/793-5501/000-005</a>
	<b>Item no.: 793-5501/000-006</b> WMB marking card; as card; stretchable 5 - 5.2 mm; plain; snap-on type	<a href="http://www.wago.com/793-5501/000-006">www.wago.com/793-5501/000-006</a>
	<b>Item no.: 793-5501/000-007</b> WMB marking card; as card; stretchable 5 - 5.2 mm; plain; snap-on type	<a href="http://www.wago.com/793-5501/000-007">www.wago.com/793-5501/000-007</a>
	<b>Item no.: 793-5501/000-012</b> WMB marking card; as card; stretchable 5 - 5.2 mm; plain; snap-on type	<a href="http://www.wago.com/793-5501/000-012">www.wago.com/793-5501/000-012</a>



**Item no.: 793-5501/000-014**  
WMB marking card; as card; stretchable 5 - 5.2 mm; plain; snap-on type

[www.wago.com/793-5501/000-014](http://www.wago.com/793-5501/000-014)



**Item no.: 793-5501/000-017**  
WMB marking card; as card; stretchable 5 - 5.2 mm; plain; snap-on type

[www.wago.com/793-5501/000-017](http://www.wago.com/793-5501/000-017)



**Item no.: 793-5501/000-023**  
WMB marking card; as card; stretchable 5 - 5.2 mm; plain; snap-on type

[www.wago.com/793-5501/000-023](http://www.wago.com/793-5501/000-023)



**Item no.: 793-5501/000-024**  
WMB marking card; as card; stretchable 5 - 5.2 mm; plain; snap-on type

[www.wago.com/793-5501/000-024](http://www.wago.com/793-5501/000-024)

### clamps



**Item no.: 2002-1661**  
2-conductor carrier terminal block; for DIN-rail 35 x 15 and 35 x 7.5; 2.5 mm<sup>2</sup>; Push-in CAGE CLAMP®

[www.wago.com/2002-1661](http://www.wago.com/2002-1661)



**Item no.: 2002-1761**  
3-conductor carrier terminal block; for DIN-rail 35 x 15 and 35 x 7.5; 2.5 mm<sup>2</sup>; Push-in CAGE CLAMP®

[www.wago.com/2002-1761](http://www.wago.com/2002-1761)

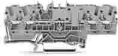

**Item no.: 2002-1861**  
4-conductor carrier terminal block; for DIN-rail 35 x 15 and 35 x 7.5; 2.5 mm<sup>2</sup>; Push-in CAGE CLAMP®

[www.wago.com/2002-1861](http://www.wago.com/2002-1861)



**Item no.: 2002-1961**  
2-conductor carrier terminal block; with additional jumper position; for DIN-rail 35 x 15 and 35 x 7.5; 2.5 mm<sup>2</sup>; Push-in CAGE CLAMP®

[www.wago.com/2002-1961](http://www.wago.com/2002-1961)

### Downloads

#### Documentation

#### Bid Text

2002-820	Aug 13, 2018	DOCX 14.6 kB	Download
----------	--------------	-----------------	----------

### smartDATA

#### CAD data

3D Download 2002-820	URL	Download
----------------------	-----	----------



## Product family

### TOPJOB® S

TOPJOB® S: In various industrial applications and modern building installations, WAGO's wide and versatile range of rail-mount terminal blocks provides more than just reliable electrical connections.

[Learn more about the product family.](#)

[Show all products from the family](#)

Subject to changes.

---

WAGO Kontakttechnik GmbH & Co. KG  
Hansastr. 27  
32423 Minden  
Phone: +49571 887-0 | Fax: +49571 887-169  
Email: [info.de@wago.com](mailto:info.de@wago.com) | Web: [www.wago.com](http://www.wago.com)

Do you have any questions about our products?  
We are always happy to take your call at +49 (571) 887-44222.