

Data sheet | Item number: 2003-6649

Multilevel installation terminal block; 4 mm<sup>2</sup>; N/L; Push-in CAGE CLAMP®

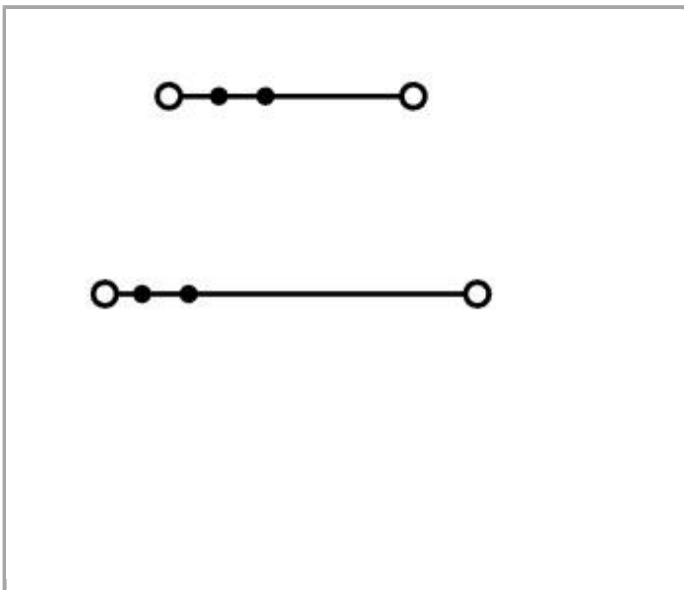

[www.wago.com/2003-6649](http://www.wago.com/2003-6649)

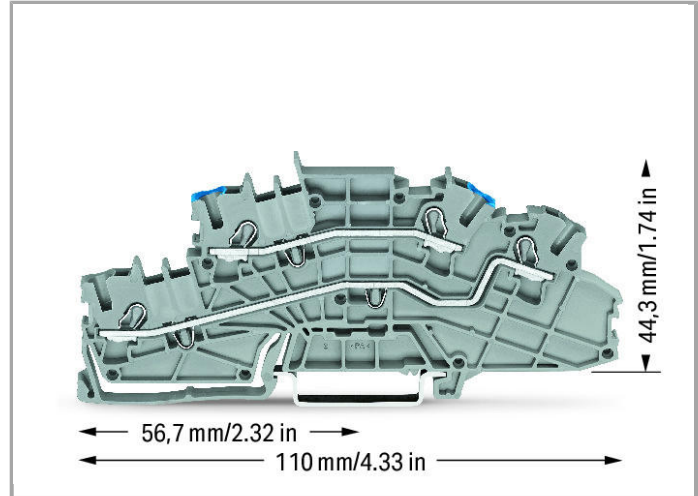
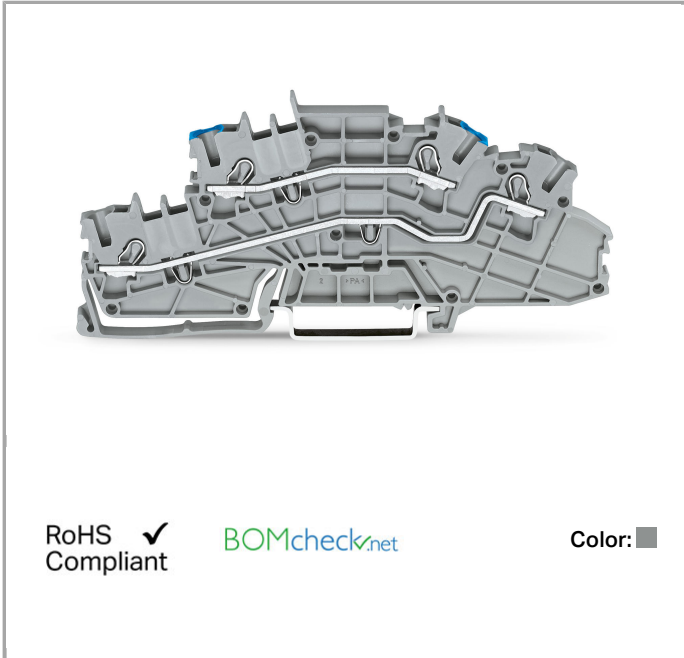

Data

Electrical data

Ratings per IEC/EN 60664-1

Rated voltage (III / 3)

400 V



Rated impulse voltage (III / 3)	6 kV
Rated current	25 A
Legend (ratings)	(III / 3) $\hat{=}$ Overvoltage category III / Pollution degree 3

### Approvals per UL 1059

Rated voltage UL (Use Group B)	300 V
Rated current UL (Use Group B)	20 A
Rated voltage UL (Use Group C)	300 V
Rated current UL (Use Group C)	20 A

### Approvals per CSA

Rated voltage CSA (Use Group C)	300 V
Rated current CSA (Use Group C)	20 A

### Connection data

Connection technology	Push-in CAGE CLAMP <sup>®</sup>
Actuation type	Push-in Operating tool
Connectable conductor materials	Copper
Nominal cross section	2.5 mm <sup>2</sup>
Solid conductor	0.25 ... 4 mm <sup>2</sup> / 22 ... 12 AWG
Solid conductor, push-in termination	0.75 ... 4 mm <sup>2</sup> / 18 ... 12 AWG
Fine-stranded conductor	0.25 ... 4 mm <sup>2</sup> / 22 ... 12 AWG
Fine-stranded conductor with ferrule, push-in termination, from	0.75 mm <sup>2</sup> / 18 AWG
Strip length	10 ... 12 mm / 0.39 ... 0.47 Inch
Total number of connection points	4
Total number of potentials	3
Number of levels	3
Type of wiring	Front-entry wiring

### Geometrical Data

Width	5.2 mm / 0.205 inch
Height from upper-edge of DIN-35 rail	44.3 mm / 1.744 inch
Depth	110 mm / 4.331 inch

### Mechanical data

Design	angled
Type of mounting	DIN-35 rail
Potential marking	N/L
Marking level	Center/side marking

## Material Data



Color	gray
Insulating material	Polyamide 66 (PA 66)
Fire load	0.307 MJ
Weight	17.232 g

## Commercial data

Country of origin	CN
GTIN	4050821322078
Customs Tariff No.	85369010000
Product Group	22 (TOPJOB S)

## Approvals / Certificates

### Country specific Approvals

Logo	Approval	Certificate name
	CCA DEKRA Certification B.V.	2196143:01
	CCA DEKRA Certification B.V.	NTR NL 7519
	CSA DEKRA Certification B.V.	70111102

### UL-Approvals

Logo	Approval	Certificate name
	UL Underwriters Laboratories Inc.	E45172

## Compatible products

### End plate

	Item no.: 2003-6692 End and intermediate plate; 0.8 mm thick	<a href="http://www.wago.com/2003-6692">www.wago.com/2003-6692</a>
--	---	--

### Insulation stop



**Item no.: 2002-171**  
Insulation stop; 0.25 - 0.5 mm<sup>2</sup>; 5 pieces/strip

[www.wago.com/2002-171](http://www.wago.com/2002-171)



**Item no.: 2002-172**  
Insulation stop; 0.75 - 1 mm<sup>2</sup>; 5 pieces/strip

[www.wago.com/2002-172](http://www.wago.com/2002-172)

### Marking accessories



**Item no.: 2009-110**  
Marking strips; on reel; not stretchable; plain; snap-on type

[www.wago.com/2009-110](http://www.wago.com/2009-110)



**Item no.: 2009-115**  
WMB-Inline; for smartPRINTER; on reel; stretchable 5 - 5.2 mm; plain; snap-on type

[www.wago.com/2009-115](http://www.wago.com/2009-115)



**Item no.: 2009-115/000-002**  
WMB-Inline; for smartPRINTER; on reel; stretchable 5 - 5.2 mm; plain; snap-on type

[www.wago.com/2009-115/000-002](http://www.wago.com/2009-115/000-002)



**Item no.: 2009-115/000-006**  
WMB-Inline; for smartPRINTER; on reel; stretchable 5 - 5.2 mm; plain; snap-on type

[www.wago.com/2009-115/000-006](http://www.wago.com/2009-115/000-006)



**Item no.: 2009-115/000-007**  
WMB-Inline; for smartPRINTER; on reel; stretchable 5 - 5.2 mm; plain; snap-on type

[www.wago.com/2009-115/000-007](http://www.wago.com/2009-115/000-007)



**Item no.: 2009-115/000-012**  
WMB-Inline; for smartPRINTER; on reel; stretchable 5 - 5.2 mm; plain; snap-on type

[www.wago.com/2009-115/000-012](http://www.wago.com/2009-115/000-012)



**Item no.: 2009-115/000-017**  
WMB-Inline; for smartPRINTER; on reel; stretchable 5 - 5.2 mm; plain; snap-on type

[www.wago.com/2009-115/000-017](http://www.wago.com/2009-115/000-017)



**Item no.: 2009-115/000-023**  
WMB-Inline; for smartPRINTER; on reel; stretchable 5 - 5.2 mm; plain; snap-on type

[www.wago.com/2009-115/000-023](http://www.wago.com/2009-115/000-023)



**Item no.: 2009-115/000-024**  
WMB-Inline; for smartPRINTER; on reel; stretchable 5 - 5.2 mm; plain; snap-on type

[www.wago.com/2009-115/000-024](http://www.wago.com/2009-115/000-024)



**Item no.: 2009-145**  
Mini-WSB Inline; for smartPRINTER; on reel; stretchable 5 - 5.2 mm; plain; snap-on type

[www.wago.com/2009-145](http://www.wago.com/2009-145)



**Item no.: 2009-145/000-002**  
Mini-WSB Inline; for smartPRINTER; on reel; stretchable 5 - 5.2 mm; plain; snap-on type

[www.wago.com/2009-145/000-002](http://www.wago.com/2009-145/000-002)



















**Item no.: 2009-145/000-005**  
Mini-WSB Inline; for smartPRINTER; on reel; stretchable 5 - 5.2 mm; plain; snap-on type

[www.wago.com/2009-145/000-005](http://www.wago.com/2009-145/000-005)



**Item no.: 2009-145/000-006**  
Mini-WSB Inline; for smartPRINTER; on reel; stretchable 5 - 5.2 mm; plain; snap-on type

[www.wago.com/2009-145/000-006](http://www.wago.com/2009-145/000-006)

	<b>Item no.: 2009-145/000-007</b> Mini-WSB Inline; for smartPRINTER; on reel; stretchable 5 - 5.2 mm; plain; snap-on type	<a href="http://www.wago.com/2009-145/000-007">www.wago.com/2009-145/000-007</a>
	<b>Item no.: 2009-145/000-012</b> Mini-WSB Inline; for smartPRINTER; on reel; stretchable 5 - 5.2 mm; plain; snap-on type	<a href="http://www.wago.com/2009-145/000-012">www.wago.com/2009-145/000-012</a>
	<b>Item no.: 2009-145/000-023</b> Mini-WSB Inline; for smartPRINTER; on reel; stretchable 5 - 5.2 mm; plain; snap-on type	<a href="http://www.wago.com/2009-145/000-023">www.wago.com/2009-145/000-023</a>
	<b>Item no.: 2009-145/000-024</b> Mini-WSB Inline; on reel; stretchable 5 - 5.2 mm; plain; snap-on type	<a href="http://www.wago.com/2009-145/000-024">www.wago.com/2009-145/000-024</a>
	<b>Item no.: 2009-191</b> Group marker carrier	<a href="http://www.wago.com/2009-191">www.wago.com/2009-191</a>
	<b>Item no.: 2009-192</b> Group marker carrier	<a href="http://www.wago.com/2009-192">www.wago.com/2009-192</a>
	<b>Item no.: 2009-193</b> Group marker carrier	<a href="http://www.wago.com/2009-193">www.wago.com/2009-193</a>
	<b>Item no.: 2009-198</b> Adaptor	<a href="http://www.wago.com/2009-198">www.wago.com/2009-198</a>
	<b>Item no.: 248-501</b> Miniature WSB Quick marking system; plain; Marker width 5 mm; 10 strips with 10 markers per card	<a href="http://www.wago.com/248-501">www.wago.com/248-501</a>
	<b>Item no.: 248-501/000-002</b> Mini-WSB marking card; as card; not stretchable; plain; snap-on type	<a href="http://www.wago.com/248-501/000-002">www.wago.com/248-501/000-002</a>
	<b>Item no.: 248-501/000-005</b> Mini-WSB marking card; as card; plain; snap-on type	<a href="http://www.wago.com/248-501/000-005">www.wago.com/248-501/000-005</a>
	<b>Item no.: 248-501/000-006</b> Mini-WSB marking card; as card; not stretchable; plain; snap-on type	<a href="http://www.wago.com/248-501/000-006">www.wago.com/248-501/000-006</a>
	<b>Item no.: 248-501/000-007</b> Mini-WSB marking card; as card; not stretchable; plain; snap-on type	<a href="http://www.wago.com/248-501/000-007">www.wago.com/248-501/000-007</a>
	<b>Item no.: 248-501/000-012</b> Mini-WSB marking card; as card; not stretchable; plain; snap-on type	<a href="http://www.wago.com/248-501/000-012">www.wago.com/248-501/000-012</a>
	<b>Item no.: 248-501/000-017</b> Mini-WSB marking card; as card; not stretchable; plain; snap-on type	<a href="http://www.wago.com/248-501/000-017">www.wago.com/248-501/000-017</a>
	<b>Item no.: 248-501/000-023</b> Mini-WSB marking card; as card; not stretchable; plain; snap-on type	<a href="http://www.wago.com/248-501/000-023">www.wago.com/248-501/000-023</a>



**Item no.: 248-501/000-024**  
Mini-WSB marking card; as card; not stretchable; plain; snap-on type

[www.wago.com/248-501/000-024](http://www.wago.com/248-501/000-024)



**Item no.: 793-501**  
WMB marking card; as card; not stretchable; plain; snap-on type

[www.wago.com/793-501](http://www.wago.com/793-501)



**Item no.: 793-501/000-002**  
WMB marking card; as card; not stretchable; plain; snap-on type

[www.wago.com/793-501/000-002](http://www.wago.com/793-501/000-002)



**Item no.: 793-501/000-005**  
WMB marking card; as card; not stretchable; plain; snap-on type

[www.wago.com/793-501/000-005](http://www.wago.com/793-501/000-005)



**Item no.: 793-501/000-006**  
WMB marking card; as card; not stretchable; plain; snap-on type

[www.wago.com/793-501/000-006](http://www.wago.com/793-501/000-006)



**Item no.: 793-501/000-007**  
WMB marking card; as card; not stretchable; plain; snap-on type

[www.wago.com/793-501/000-007](http://www.wago.com/793-501/000-007)



**Item no.: 793-501/000-012**  
WMB marking card; as card; not stretchable; plain; snap-on type

[www.wago.com/793-501/000-012](http://www.wago.com/793-501/000-012)



**Item no.: 793-501/000-017**  
WMB marking card; as card; not stretchable; plain; snap-on type

[www.wago.com/793-501/000-017](http://www.wago.com/793-501/000-017)



**Item no.: 793-501/000-023**  
WMB marking card; as card; not stretchable; plain; snap-on type

[www.wago.com/793-501/000-023](http://www.wago.com/793-501/000-023)



**Item no.: 793-501/000-024**  
WMB marking card; as card; not stretchable; plain; snap-on type

[www.wago.com/793-501/000-024](http://www.wago.com/793-501/000-024)



**Item no.: 793-5501**  
WMB marking card; as card; for terminal block width 5 - 17.5 mm; stretchable 5 - 5.2 mm; plain; snap-on type

[www.wago.com/793-5501](http://www.wago.com/793-5501)



**Item no.: 793-5501/000-002**  
WMB marking card; as card; for terminal block width 5 - 17.5 mm; stretchable 5 - 5.2 mm; plain; snap-on type

[www.wago.com/793-5501/000-002](http://www.wago.com/793-5501/000-002)



**Item no.: 793-5501/000-005**  
WMB marking card; as card; stretchable 5 - 5.2 mm; plain; snap-on type

[www.wago.com/793-5501/000-005](http://www.wago.com/793-5501/000-005)



**Item no.: 793-5501/000-006**  
WMB marking card; as card; stretchable 5 - 5.2 mm; plain; snap-on type

[www.wago.com/793-5501/000-006](http://www.wago.com/793-5501/000-006)



**Item no.: 793-5501/000-007**  
WMB marking card; as card; stretchable 5 - 5.2 mm; plain; snap-on type

[www.wago.com/793-5501/000-007](http://www.wago.com/793-5501/000-007)



**Item no.: 793-5501/000-012**  
WMB marking card; as card; stretchable 5 - 5.2 mm; plain; snap-on type

[www.wago.com/793-5501/000-012](http://www.wago.com/793-5501/000-012)



**Item no.: 793-5501/000-017**  
WMB marking card; as card; stretchable 5 - 5.2 mm; plain; snap-on type

[www.wago.com/793-5501/000-017](http://www.wago.com/793-5501/000-017)



**Item no.: 793-5501/000-023**  
WMB marking card; as card; stretchable 5 - 5.2 mm; plain; snap-on type

[www.wago.com/793-5501/000-023](http://www.wago.com/793-5501/000-023)



**Item no.: 793-5501/000-024**  
WMB marking card; as card; stretchable 5 - 5.2 mm; plain; snap-on type

[www.wago.com/793-5501/000-024](http://www.wago.com/793-5501/000-024)

### assembling



**Item no.: 2009-304**  
Busbar carrier; not suitable for use as end stop; for DIN 35 rail; 1.5 mm thick

[www.wago.com/2009-304](http://www.wago.com/2009-304)



**Item no.: 2009-305**  
Busbar carrier; with end stop function and detachable separator plate; for DIN 35 rail; 7.5 mm thick

[www.wago.com/2009-305](http://www.wago.com/2009-305)

### check



**Item no.: 2009-174**  
Test plug adapter; for 4 mm Ø test plugs; for testing TOPJOB®S rail-mounted terminal blocks

[www.wago.com/2009-174](http://www.wago.com/2009-174)



**Item no.: 2009-182**  
Testing tap; for max. 2.5 mm<sup>2</sup>; tool-free connection for individual test wires 0.08 - 2.5 mm

[www.wago.com/2009-182](http://www.wago.com/2009-182)



**Item no.: 210-136**  
Test plug; 2 mm Ø; with 500 mm cable

[www.wago.com/210-136](http://www.wago.com/210-136)

### Jumper



**Item no.: 2002-400**  
Adjacent jumper for continuous commoning; insulated; 2-way; Nominal current 25 A

[www.wago.com/2002-400](http://www.wago.com/2002-400)



**Item no.: 2002-402**  
Push-in type jumper bar; insulated; 2-way; Nominal current 25 A

[www.wago.com/2002-402](http://www.wago.com/2002-402)



**Item no.: 2002-402/000-005**  
Push-in type jumper bar; insulated; 2-way; Nominal current 25 A

[www.wago.com/2002-402/000-005](http://www.wago.com/2002-402/000-005)



**Item no.: 2002-402/000-006**  
Push-in type jumper bar; insulated; 2-way; Nominal current 25 A

[www.wago.com/2002-402/000-006](http://www.wago.com/2002-402/000-006)



















**Item no.: 2002-403**  
Push-in type jumper bar; insulated; 3-way; Nominal current 25 A

[www.wago.com/2002-403](http://www.wago.com/2002-403)



















**Item no.: 2002-403/000-005**  
Push-in type jumper bar; insulated; 3-way; Nominal current 25 A















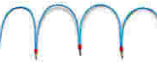

[www.wago.com/2002-403/000-005](http://www.wago.com/2002-403/000-005)

	<b>Item no.: 2002-403/000-006</b> Push-in type jumper bar; insulated; 3-way; Nominal current 25 A	<a href="http://www.wago.com/2002-403/000-006">www.wago.com/2002-403/000-006</a>
	<b>Item no.: 2002-404</b> Push-in type jumper bar; insulated; 4-way; Nominal current 25 A	<a href="http://www.wago.com/2002-404">www.wago.com/2002-404</a>
	<b>Item no.: 2002-404/000-005</b> Push-in type jumper bar; insulated; 4-way; Nominal current 25 A	<a href="http://www.wago.com/2002-404/000-005">www.wago.com/2002-404/000-005</a>
	<b>Item no.: 2002-404/000-006</b> Push-in type jumper bar; insulated; 4-way; Nominal current 25 A	<a href="http://www.wago.com/2002-404/000-006">www.wago.com/2002-404/000-006</a>
	<b>Item no.: 2002-405</b> Push-in type jumper bar; insulated; 5-way; Nominal current 25 A	<a href="http://www.wago.com/2002-405">www.wago.com/2002-405</a>
	<b>Item no.: 2002-405/000-005</b> Push-in type jumper bar; insulated; 5-way; Nominal current 25 A	<a href="http://www.wago.com/2002-405/000-005">www.wago.com/2002-405/000-005</a>
	<b>Item no.: 2002-405/000-006</b> Push-in type jumper bar; insulated; 5-way; Nominal current 25 A	<a href="http://www.wago.com/2002-405/000-006">www.wago.com/2002-405/000-006</a>
	<b>Item no.: 2002-405/011-000</b> Star point jumper; insulated; 3-way (1-3-5); IN = IN terminal block	<a href="http://www.wago.com/2002-405/011-000">www.wago.com/2002-405/011-000</a>
	<b>Item no.: 2002-406</b> Push-in type jumper bar; insulated; 6-way; Nominal current 25 A	<a href="http://www.wago.com/2002-406">www.wago.com/2002-406</a>
	<b>Item no.: 2002-406/000-005</b> Push-in type jumper bar; insulated; 6-way; Nominal current 25 A	<a href="http://www.wago.com/2002-406/000-005">www.wago.com/2002-406/000-005</a>
	<b>Item no.: 2002-406/000-006</b> Push-in type jumper bar; insulated; 6-way; Nominal current 25 A	<a href="http://www.wago.com/2002-406/000-006">www.wago.com/2002-406/000-006</a>
	<b>Item no.: 2002-406/020-000</b> Delta jumper; insulated; 1-2 3-4 5-6; IN = IN terminal block	<a href="http://www.wago.com/2002-406/020-000">www.wago.com/2002-406/020-000</a>
	<b>Item no.: 2002-407</b> Push-in type jumper bar; insulated; 7-way; Nominal current 25 A	<a href="http://www.wago.com/2002-407">www.wago.com/2002-407</a>
	<b>Item no.: 2002-407/000-005</b> Push-in type jumper bar; insulated; 7-way; Nominal current 25 A	<a href="http://www.wago.com/2002-407/000-005">www.wago.com/2002-407/000-005</a>
	<b>Item no.: 2002-407/000-006</b> Push-in type jumper bar; insulated; 7-way; Nominal current 25 A	<a href="http://www.wago.com/2002-407/000-006">www.wago.com/2002-407/000-006</a>
	<b>Item no.: 2002-408</b> Push-in type jumper bar; insulated; 8-way; Nominal current 25 A	<a href="http://www.wago.com/2002-408">www.wago.com/2002-408</a>



	<b>Item no.: 2002-408/000-005</b> Push-in type jumper bar; insulated; 8-way; Nominal current 25 A	<a href="http://www.wago.com/2002-408/000-005">www.wago.com/2002-408/000-005</a>
	<b>Item no.: 2002-408/000-006</b> Push-in type jumper bar; insulated; 8-way; Nominal current 25 A	<a href="http://www.wago.com/2002-408/000-006">www.wago.com/2002-408/000-006</a>
	<b>Item no.: 2002-409</b> Push-in type jumper bar; insulated; 9-way; Nominal current 25 A	<a href="http://www.wago.com/2002-409">www.wago.com/2002-409</a>
	<b>Item no.: 2002-409/000-005</b> Push-in type jumper bar; insulated; 9-way; Nominal current 25 A	<a href="http://www.wago.com/2002-409/000-005">www.wago.com/2002-409/000-005</a>
	<b>Item no.: 2002-409/000-006</b> Push-in type jumper bar; insulated; 9-way; Nominal current 25 A	<a href="http://www.wago.com/2002-409/000-006">www.wago.com/2002-409/000-006</a>
	<b>Item no.: 2002-410</b> Push-in type jumper bar; insulated; 10-way; Nominal current 25 A	<a href="http://www.wago.com/2002-410">www.wago.com/2002-410</a>
	<b>Item no.: 2002-410/000-005</b> Push-in type jumper bar; insulated; 10-way; Nominal current 25 A	<a href="http://www.wago.com/2002-410/000-005">www.wago.com/2002-410/000-005</a>
	<b>Item no.: 2002-410/000-006</b> Push-in type jumper bar; insulated; 10-way; Nominal current 25 A	<a href="http://www.wago.com/2002-410/000-006">www.wago.com/2002-410/000-006</a>
	<b>Item no.: 2002-423</b> Push-in type jumper bar; insulated; from 1 to 3; Nominal current 25 A	<a href="http://www.wago.com/2002-423">www.wago.com/2002-423</a>
	<b>Item no.: 2002-423/000-005</b> Adjacent jumper for continuous commoning; insulated; from 1 to 3; Nominal current 25 A	<a href="http://www.wago.com/2002-423/000-005">www.wago.com/2002-423/000-005</a>
	<b>Item no.: 2002-423/000-006</b> Adjacent jumper for continuous commoning; insulated; from 1 to 3; Nominal current 25 A	<a href="http://www.wago.com/2002-423/000-006">www.wago.com/2002-423/000-006</a>
	<b>Item no.: 2002-433</b> Push-in type jumper bar; insulated; from 1 to 3; Nominal current 25 A	<a href="http://www.wago.com/2002-433">www.wago.com/2002-433</a>
	<b>Item no.: 2002-434</b> Push-in type jumper bar; insulated; from 1 to 4; Nominal current 25 A	<a href="http://www.wago.com/2002-434">www.wago.com/2002-434</a>
	<b>Item no.: 2002-435</b> Push-in type jumper bar; insulated; from 1 to 5; Nominal current 25 A	<a href="http://www.wago.com/2002-435">www.wago.com/2002-435</a>
	<b>Item no.: 2002-436</b> Push-in type jumper bar; insulated; from 1 to 6; Nominal current 25 A	<a href="http://www.wago.com/2002-436">www.wago.com/2002-436</a>
	<b>Item no.: 2002-437</b> Push-in type jumper bar; insulated; from 1 to 7; Nominal current 25 A	<a href="http://www.wago.com/2002-437">www.wago.com/2002-437</a>
	<b>Item no.: 2002-438</b> Push-in type jumper bar; insulated; from 1 to 8; Nominal current 25 A	<a href="http://www.wago.com/2002-438">www.wago.com/2002-438</a>









	<b>Item no.: 2002-439</b> Push-in type jumper bar; insulated; from 1 to 9; Nominal current 25 A	<a href="http://www.wago.com/2002-439">www.wago.com/2002-439</a>
	<b>Item no.: 2002-440</b> Push-in type jumper bar; insulated; from 1 to 10; Nominal current 25 A	<a href="http://www.wago.com/2002-440">www.wago.com/2002-440</a>
	<b>Item no.: 2002-472</b> Staggered jumper; insulated; 2-way; Nominal current 25 A; suitable for 2002 and 2003 Series rail-mounted terminal blocks	<a href="http://www.wago.com/2002-472">www.wago.com/2002-472</a>
	<b>Item no.: 2002-473</b> Staggered jumper; insulated; 3-way; Nominal current 25 A; suitable for 2002 and 2003 Series rail-mounted terminal blocks	<a href="http://www.wago.com/2002-473">www.wago.com/2002-473</a>
	<b>Item no.: 2002-473/011-000</b> Ready-made staggered jumper; insulated; 2-way (1-3); Nominal current 25 A; with contact lugs broken off at the factory and circuit marking	<a href="http://www.wago.com/2002-473/011-000">www.wago.com/2002-473/011-000</a>
	<b>Item no.: 2002-474</b> Staggered jumper; insulated; 4-way; Nominal current 25 A; suitable for 2002 and 2003 Series rail-mounted terminal blocks	<a href="http://www.wago.com/2002-474">www.wago.com/2002-474</a>
	<b>Item no.: 2002-475</b> Staggered jumper; insulated; 5-way; Nominal current 25 A; suitable for 2002 and 2003 Series rail-mounted terminal blocks	<a href="http://www.wago.com/2002-475">www.wago.com/2002-475</a>
	<b>Item no.: 2002-475/011-000</b> Ready-made staggered jumper; insulated; 3-way (1-3-5); Nominal current 25 A; with contact lugs broken off at the factory and circuit marking	<a href="http://www.wago.com/2002-475/011-000">www.wago.com/2002-475/011-000</a>
	<b>Item no.: 2002-476</b> Staggered jumper; insulated; 6-way; Nominal current 25 A; suitable for 2002 and 2003 Series rail-mounted terminal blocks	<a href="http://www.wago.com/2002-476">www.wago.com/2002-476</a>
	<b>Item no.: 2002-477</b> Staggered jumper; insulated; 7-way; Nominal current 25 A; suitable for 2002 and 2003 Series rail-mounted terminal blocks	<a href="http://www.wago.com/2002-477">www.wago.com/2002-477</a>
	<b>Item no.: 2002-477/011-000</b> Ready-made staggered jumper; insulated; 1-3-5-7; Nominal current 25 A; with contact lugs broken off at the factory and circuit marking	<a href="http://www.wago.com/2002-477/011-000">www.wago.com/2002-477/011-000</a>
	<b>Item no.: 2002-478</b> Staggered jumper; insulated; 8-way; Nominal current 25 A; suitable for 2002 and 2003 Series rail-mounted terminal blocks	<a href="http://www.wago.com/2002-478">www.wago.com/2002-478</a>
	<b>Item no.: 2002-479</b> Staggered jumper; insulated; 9-way; Nominal current 25 A; suitable for 2002 and 2003 Series rail-mounted terminal blocks	<a href="http://www.wago.com/2002-479">www.wago.com/2002-479</a>
	<b>Item no.: 2002-479/011-000</b> Ready-made staggered jumper; insulated; 1-3-5-7-9; Nominal current 25 A; with contact lugs broken off at the factory and circuit marking	<a href="http://www.wago.com/2002-479/011-000">www.wago.com/2002-479/011-000</a>
	<b>Item no.: 2002-480</b> Staggered jumper; insulated; 10-way; Nominal current 25 A; suitable for 2002 and 2003 Series rail-mounted terminal blocks	<a href="http://www.wago.com/2002-480">www.wago.com/2002-480</a>
	<b>Item no.: 2002-481</b> Staggered jumper; insulated; 11-way; Nominal current 25 A; suitable for 2002 and 2003 Series rail-mounted terminal blocks	<a href="http://www.wago.com/2002-481">www.wago.com/2002-481</a>
	<b>Item no.: 2002-481/011-000</b> Ready-made staggered jumper; insulated; 1-3-5-7-9-11; Nominal current 25 A; with contact lugs broken off at the factory and circuit marking	<a href="http://www.wago.com/2002-481/011-000">www.wago.com/2002-481/011-000</a>

	<b>Item no.: 2002-482</b> Staggered jumper; insulated; 12-way; Nominal current 25 A; suitable for 2002 and 2003 Series rail-mounted terminal blocks	<a href="http://www.wago.com/2002-482">www.wago.com/2002-482</a>
	<b>Item no.: 2009-412</b> Push-in type wire jumper; insulated; wire length 60 mm; Conductor cross section 1.5 mm <sup>2</sup> ; suitable for 2001, 2002, 2003 and 2022 Series rail-mounted terminal blocks	<a href="http://www.wago.com/2009-412">www.wago.com/2009-412</a>
	<b>Item no.: 2009-414</b> Push-in type wire jumper; insulated; wire length 110 mm; Conductor cross section 1.5 mm <sup>2</sup> ; suitable for 2001, 2002, 2003 and 2022 Series rail-mounted terminal blocks	<a href="http://www.wago.com/2009-414">www.wago.com/2009-414</a>
	<b>Item no.: 2009-416</b> Push-in type wire jumper; insulated; wire length 250 mm; Conductor cross section 1.5 mm <sup>2</sup> ; suitable for 2001, 2002, 2003 and 2022 Series rail-mounted terminal blocks	<a href="http://www.wago.com/2009-416">www.wago.com/2009-416</a>
	<b>Item no.: 210-103</b> Wire commoning chain; insulated; 50 connections	<a href="http://www.wago.com/210-103">www.wago.com/210-103</a>
	<b>Item no.: 210-123</b> Wire commoning chain; insulated; 50 connections	<a href="http://www.wago.com/210-123">www.wago.com/210-123</a>
<b>tools</b>		
	<b>Item no.: 2009-309</b> Operating tool; Blades: 3.5 mm and 2.5 mm; for TOPJOB®S installation terminal blocks	<a href="http://www.wago.com/2009-309">www.wago.com/2009-309</a>
	<b>Item no.: 2009-310</b> Operating tool; Blades: 3.5 mm and 5.5 mm; for TOPJOB®S installation terminal blocks	<a href="http://www.wago.com/2009-310">www.wago.com/2009-310</a>
	<b>Item no.: 210-658</b> Operating tool with partially insulated shaft; Blade (3.5 x 0.5) mm; short; angled	<a href="http://www.wago.com/210-658">www.wago.com/210-658</a>
	<b>Item no.: 210-720</b> Operating tool with partially insulated shaft; Type 2, blade (3.5 x 0.5) mm	<a href="http://www.wago.com/210-720">www.wago.com/210-720</a>
<b>Carrier rail</b>		
	<b>Item no.: 210-112</b> Steel carrier rail; 35 x 7.5 mm; 1 mm thick; 2 m long; slotted; according to EN 60715; "Hole width 25 mm	<a href="http://www.wago.com/210-112">www.wago.com/210-112</a>
	<b>Item no.: 210-113</b> Steel carrier rail; 35 x 7.5 mm; 1 mm thick; 2 m long; unslotted; according to EN 60715	<a href="http://www.wago.com/210-113">www.wago.com/210-113</a>
	<b>Item no.: 210-114</b> Steel carrier rail; 35 x 15 mm; 1.5 mm thick; 2 m long; unslotted; similar to EN 60715	<a href="http://www.wago.com/210-114">www.wago.com/210-114</a>
	<b>Item no.: 210-115</b> Steel carrier rail; 35 x 7.5 mm; 1 mm thick; 2 m long; slotted; according to EN 60715; "Hole width 18 mm	<a href="http://www.wago.com/210-115">www.wago.com/210-115</a>
	<b>Item no.: 210-118</b> Steel carrier rail; 35 x 15 mm; 2.3 mm thick; 2 m long; unslotted; according to EN 60715	<a href="http://www.wago.com/210-118">www.wago.com/210-118</a>
	<b>Item no.: 210-196</b> Aluminum carrier rail; 35 x 8.2 mm; 1.6 mm thick; 2 m long; unslotted; similar to EN 60715	<a href="http://www.wago.com/210-196">www.wago.com/210-196</a>
	<b>Item no.: 210-197</b> Steel carrier rail; 35 x 15 mm; 1.5 mm thick; 2 m long; slotted; similar to EN 60715	<a href="http://www.wago.com/210-197">www.wago.com/210-197</a>

**Item no.: 210-198**

Copper carrier rail; 35 x 15 mm; 2.3 mm thick; 2 m long; unslotted; according to EN 60715

[www.wago.com/210-198](http://www.wago.com/210-198)**ferrule**

	<b>Item no.: 216-241</b> Ferrule; Sleeve for 0.5 mm <sup>2</sup> / AWG 22; insulated; electro-tin plated; electrolytic copper; gastight crimped; acc. to DIN 46228, Part 4/09.90	<a href="http://www.wago.com/216-241">www.wago.com/216-241</a>
	<b>Item no.: 216-242</b> Ferrule; Sleeve for 0.75 mm <sup>2</sup> / AWG 20; insulated; electro-tin plated; electrolytic copper; gastight crimped; acc. to DIN 46228, Part 4/09.90	<a href="http://www.wago.com/216-242">www.wago.com/216-242</a>
	<b>Item no.: 216-243</b> Ferrule; Sleeve for 1 mm <sup>2</sup> / AWG 18; insulated; electro-tin plated; electrolytic copper; gastight crimped; acc. to DIN 46228, Part 4/09.90	<a href="http://www.wago.com/216-243">www.wago.com/216-243</a>
	<b>Item no.: 216-244</b> Ferrule; Sleeve for 1.5 mm <sup>2</sup> / AWG 16; insulated; electro-tin plated; electrolytic copper; gastight crimped; acc. to DIN 46228, Part 4/09.90	<a href="http://www.wago.com/216-244">www.wago.com/216-244</a>
	<b>Item no.: 216-246</b> Ferrule; Sleeve for 2.5 mm <sup>2</sup> / AWG 14; insulated; electro-tin plated; electrolytic copper; gastight crimped; acc. to DIN 46228, Part 4/09.90	<a href="http://www.wago.com/216-246">www.wago.com/216-246</a>
	<b>Item no.: 216-262</b> Ferrule; Sleeve for 0.75 mm <sup>2</sup> / AWG 20; insulated; electro-tin plated; electrolytic copper; gastight crimped; acc. to DIN 46228, Part 4/09.90	<a href="http://www.wago.com/216-262">www.wago.com/216-262</a>
	<b>Item no.: 216-263</b> Ferrule; Sleeve for 1 mm <sup>2</sup> / AWG 18; insulated; electro-tin plated; electrolytic copper; gastight crimped; acc. to DIN 46228, Part 4/09.90	<a href="http://www.wago.com/216-263">www.wago.com/216-263</a>
	<b>Item no.: 216-264</b> Ferrule; Sleeve for 1.5 mm <sup>2</sup> / AWG 16; insulated; electro-tin plated; electrolytic copper; gastight crimped; acc. to DIN 46228, Part 4/09.90	<a href="http://www.wago.com/216-264">www.wago.com/216-264</a>
	<b>Item no.: 216-266</b> Ferrule; Sleeve for 2.5 mm <sup>2</sup> / AWG 14; insulated; electro-tin plated; electrolytic copper; gastight crimped; acc. to DIN 46228, Part 4/09.90	<a href="http://www.wago.com/216-266">www.wago.com/216-266</a>

**Protective Warning Marker****Item no.: 2002-115**

Protective warning marker; with high-voltage symbol, black; for 5 terminal blocks

[www.wago.com/2002-115](http://www.wago.com/2002-115)**Downloads****Documentation****Bid Text**

2003-6649	Aug 13, 2018	DOCX 15.0 kB	Download
-----------	--------------	-----------------	----------

**smartDATA****CAD data**

3D Download 2003-6649



[URL](#)

[Download](#)

---

Subject to changes.

---

WAGO Kontakttechnik GmbH & Co. KG  
Hansastr. 27  
32423 Minden  
Phone: +49571 887-0 | Fax: +49571 887-169  
Email: [info.de@wago.com](mailto:info.de@wago.com) | Web: [www.wago.com](http://www.wago.com)

Do you have any questions about our products?  
We are always happy to take your call at +49 (571) 887-44222.