

Data sheet | Item number: 2016-7601

2-conductor supply terminal blocks for distribution boxes; 16 mm²; side and center marking; for DIN-rail 35 x 15 and 35 x 7.5; Push-in CAGE CLAMP®

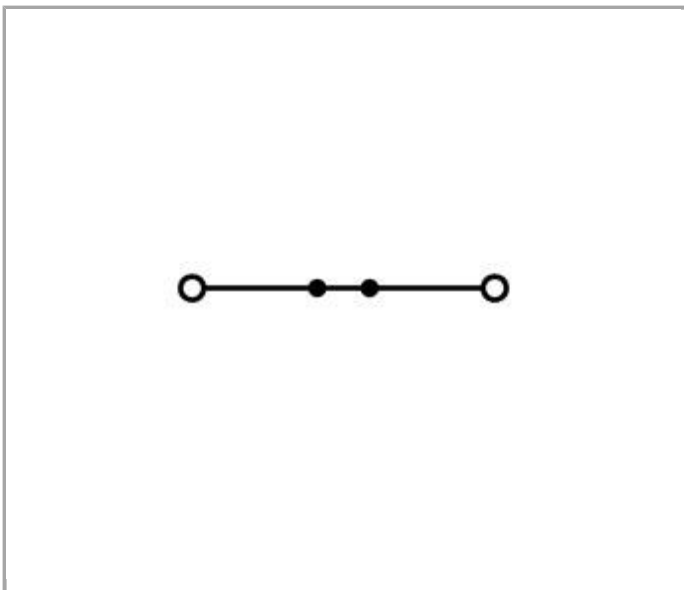

www.wago.com/2016-7601

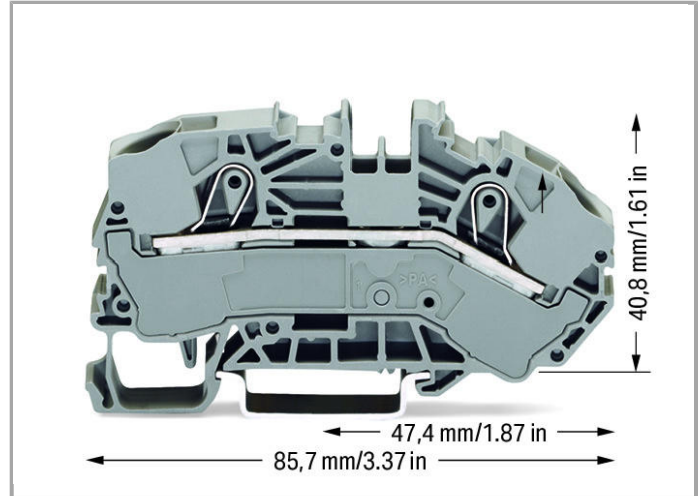
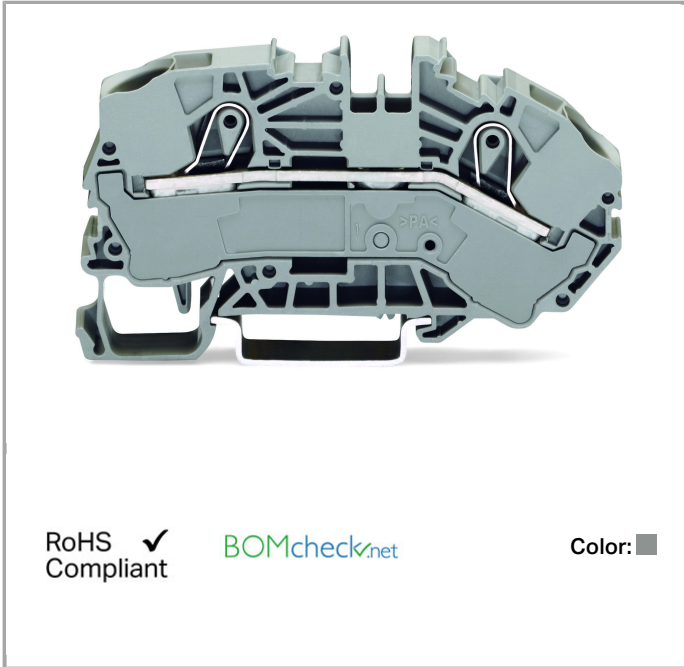

Data

Electrical data

Ratings per IEC/EN 60664-1

Rated voltage (III / 3)

800 V

Rated impulse voltage (III / 3)	8 kV
Rated current	76 A
Legend (ratings)	(III / 3) $\hat{=}$ Overvoltage category III / Pollution degree 3

Connection data

Connection technology	Push-in CAGE CLAMP [®]
Actuation type	Push-in Operating tool
Connectable conductor materials	Copper
Nominal cross section	16 mm ²
Solid conductor	0.5 ... 16 mm ² / 20 ... 6 AWG
Solid conductor, push-in termination	6 ... 16 mm ² / 14 ... 6 AWG
Fine-stranded conductor	0.5 ... 25 mm ² / 20 ... 4 AWG
Fine-stranded conductor with ferrule, push-in termination, from	6 mm ² / 14 AWG
Strip length	18 ... 20 mm / 0.71 ... 0.79 Inch
Total number of connection points	2
Total number of potentials	1
Number of levels	1
Type of wiring	Front-entry wiring

Geometrical Data

Width	12 mm / 0.472 inch
Height from upper-edge of DIN-35 rail	40.8 mm / 1.606 inch
Depth	85.7 mm / 3.374 inch

Mechanical data

Design	angled
Type of mounting	DIN-35 rail
Marking level	Center/side marking

Material Data

Color	gray
Insulating material	Polyamide 66 (PA 66)
Fire load	0.532 MJ
Weight	29.43 g

Commercial data

Country of origin	PL
GTIN	4045454725082
Customs Tariff No.	85369010000

Product Group

22 (TOPJOB S)

Approvals / Certificates

Country specific Approvals







Logo	Approval	Certificate name
	CCA DEKRA Certification B.V.	2172580.01
	CCA DEKRA Certification B.V.	NTR NL-7294

Ship Approvals

Logo	Approval	Certificate name
	ABS American Bureau of Shipping	14-HG1293677-PDA

Compatible products







ferrule

	Item no.: 216-210 Ferrule; Sleeve for 16 mm ² / AWG 6; insulated; electro-tin plated; electrolytic copper; gastight crimped; acc. to DIN 46228, Part 4/09.90	www.wago.com/216-210
	Item no.: 216-284 Ferrule; Sleeve for 1.5 mm ² / AWG 16; insulated; electro-tin plated; electrolytic copper; gastight crimped; acc. to DIN 46228, Part 4/09.90	www.wago.com/216-284
	Item no.: 216-286 Ferrule; Sleeve for 2.5 mm ² / AWG 14; insulated; electro-tin plated; electrolytic copper; gastight crimped; acc. to DIN 46228, Part 4/09.90	www.wago.com/216-286
	Item no.: 216-287 Ferrule; Sleeve for 4 mm ² / AWG 12; insulated; electro-tin plated; electrolytic copper; gastight crimped; acc. to DIN 46228, Part 4/09.90	www.wago.com/216-287
	Item no.: 216-288 Ferrule; Sleeve for 6 mm ² / AWG 10; insulated; electro-tin plated; electrolytic copper; gastight crimped; acc. to DIN 46228, Part 4/09.90	www.wago.com/216-288
	Item no.: 216-289 Ferrule; Sleeve for 10 mm ² / AWG 8; insulated; electro-tin plated; electrolytic copper; gastight crimped; acc. to DIN 46228, Part 4/09.90	www.wago.com/216-289

Protective Warning Marker

	Item no.: 2016-115 Protective warning marker; with high-voltage symbol, black; for 5 terminal blocks	www.wago.com/2016-115
--	--	--

Carrier rail

	Item no.: 210-112 Steel carrier rail; 35 x 7.5 mm; 1 mm thick; 2 m long; slotted; according to EN 60715; "Hole width 25 mm	www.wago.com/210-112
	Item no.: 210-113 Steel carrier rail; 35 x 7.5 mm; 1 mm thick; 2 m long; unslotted; according to EN 60715	www.wago.com/210-113
	Item no.: 210-114 Steel carrier rail; 35 x 15 mm; 1.5 mm thick; 2 m long; unslotted; similar to EN 60715	www.wago.com/210-114
	Item no.: 210-115 Steel carrier rail; 35 x 7.5 mm; 1 mm thick; 2 m long; slotted; according to EN 60715; "Hole width 18 mm	www.wago.com/210-115
	Item no.: 210-118 Steel carrier rail; 35 x 15 mm; 2.3 mm thick; 2 m long; unslotted; according to EN 60715	www.wago.com/210-118
	Item no.: 210-196 Aluminum carrier rail; 35 x 8.2 mm; 1.6 mm thick; 2 m long; unslotted; similar to EN 60715	www.wago.com/210-196
	Item no.: 210-197 Steel carrier rail; 35 x 15 mm; 1.5 mm thick; 2 m long; slotted; similar to EN 60715	www.wago.com/210-197
	Item no.: 210-198 Copper carrier rail; 35 x 15 mm; 2.3 mm thick; 2 m long; unslotted; according to EN 60715	www.wago.com/210-198







End plate



	Item no.: 2016-7691 End and intermediate plate; 1 mm thick	www.wago.com/2016-7691
	Item no.: 2016-7692 End and intermediate plate; 1 mm thick	www.wago.com/2016-7692

tools







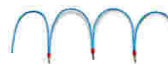





	Item no.: 210-721 Operating tool with partially insulated shaft; Type 3, blade (5.5 x 0.8) mm	www.wago.com/210-721
--	---	--

















Jumper

	Item no.: 2016-402 Push-in type jumper bar; insulated; 2-way; Nominal current 76 A	www.wago.com/2016-402
	Item no.: 2016-403 Push-in type jumper bar; insulated; 3-way; Nominal current 76 A	www.wago.com/2016-403
	Item no.: 2016-404 Push-in type jumper bar; insulated; 4-way; Nominal current 76 A	www.wago.com/2016-404
	Item no.: 2016-405 Push-in type jumper bar; insulated; 5-way; Nominal current 76 A	www.wago.com/2016-405
	Item no.: 2016-405/011-000 Star point jumper; insulated; 3-way (1-3-5); IN = IN terminal block	www.wago.com/2016-405/011-000
	Item no.: 2016-433 Push-in type jumper bar; insulated; from 1 to 3; Nominal current 76 A	www.wago.com/2016-433

	Item no.: 2016-434 Push-in type jumper bar; insulated; from 1 to 4; Nominal current 76 A	www.wago.com/2016-434
	Item no.: 2016-435 Push-in type jumper bar; insulated; from 1 to 5; Nominal current 76 A	www.wago.com/2016-435
	Item no.: 210-123 Wire commoning chain; insulated; 50 connections	www.wago.com/210-123

Marking accessories

	Item no.: 2009-110 Marking strips; on reel; not stretchable; plain; snap-on type	www.wago.com/2009-110
	Item no.: 2009-115 WMB-Inline; for smartPRINTER; on reel; stretchable 5 - 5.2 mm; plain; snap-on type	www.wago.com/2009-115
	Item no.: 2009-115/000-002 WMB-Inline; for smartPRINTER; on reel; stretchable 5 - 5.2 mm; plain; snap-on type	www.wago.com/2009-115/000-002
	Item no.: 2009-115/000-006 WMB-Inline; for smartPRINTER; on reel; stretchable 5 - 5.2 mm; plain; snap-on type	www.wago.com/2009-115/000-006
	Item no.: 2009-115/000-007 WMB-Inline; for smartPRINTER; on reel; stretchable 5 - 5.2 mm; plain; snap-on type	www.wago.com/2009-115/000-007
	Item no.: 2009-115/000-012 WMB-Inline; for smartPRINTER; on reel; stretchable 5 - 5.2 mm; plain; snap-on type	www.wago.com/2009-115/000-012
	Item no.: 2009-115/000-017 WMB-Inline; for smartPRINTER; on reel; stretchable 5 - 5.2 mm; plain; snap-on type	www.wago.com/2009-115/000-017
	Item no.: 2009-115/000-023 WMB-Inline; for smartPRINTER; on reel; stretchable 5 - 5.2 mm; plain; snap-on type	www.wago.com/2009-115/000-023
	Item no.: 2009-115/000-024 WMB-Inline; for smartPRINTER; on reel; stretchable 5 - 5.2 mm; plain; snap-on type	www.wago.com/2009-115/000-024
	Item no.: 2009-145 Mini-WSB Inline; for smartPRINTER; on reel; stretchable 5 - 5.2 mm; plain; snap-on type	www.wago.com/2009-145
	Item no.: 2009-145/000-002 Mini-WSB Inline; for smartPRINTER; on reel; stretchable 5 - 5.2 mm; plain; snap-on type	www.wago.com/2009-145/000-002
	Item no.: 2009-145/000-005 Mini-WSB Inline; for smartPRINTER; on reel; stretchable 5 - 5.2 mm; plain; snap-on type	www.wago.com/2009-145/000-005
	Item no.: 2009-145/000-006 Mini-WSB Inline; for smartPRINTER; on reel; stretchable 5 - 5.2 mm; plain; snap-on type	www.wago.com/2009-145/000-006

	Item no.: 2009-145/000-007 Mini-WSB Inline; for smartPRINTER; on reel; stretchable 5 - 5.2 mm; plain; snap-on type	www.wago.com/2009-145/000-007
	Item no.: 2009-145/000-012 Mini-WSB Inline; for smartPRINTER; on reel; stretchable 5 - 5.2 mm; plain; snap-on type	www.wago.com/2009-145/000-012
	Item no.: 2009-145/000-023 Mini-WSB Inline; for smartPRINTER; on reel; stretchable 5 - 5.2 mm; plain; snap-on type	www.wago.com/2009-145/000-023
	Item no.: 2009-145/000-024 Mini-WSB Inline; on reel; stretchable 5 - 5.2 mm; plain; snap-on type	www.wago.com/2009-145/000-024
	Item no.: 2009-191 Group marker carrier	www.wago.com/2009-191
	Item no.: 2009-192 Group marker carrier	www.wago.com/2009-192
	Item no.: 2009-193 Group marker carrier	www.wago.com/2009-193
	Item no.: 2009-198 Adaptor	www.wago.com/2009-198
	Item no.: 248-501 Miniature WSB Quick marking system; plain; Marker width 5 mm; 10 strips with 10 markers per card	www.wago.com/248-501
	Item no.: 248-501/000-002 Mini-WSB marking card; as card; not stretchable; plain; snap-on type	www.wago.com/248-501/000-002
	Item no.: 248-501/000-005 Mini-WSB marking card; as card; plain; snap-on type	www.wago.com/248-501/000-005
	Item no.: 248-501/000-006 Mini-WSB marking card; as card; not stretchable; plain; snap-on type	www.wago.com/248-501/000-006
	Item no.: 248-501/000-007 Mini-WSB marking card; as card; not stretchable; plain; snap-on type	www.wago.com/248-501/000-007
	Item no.: 248-501/000-012 Mini-WSB marking card; as card; not stretchable; plain; snap-on type	www.wago.com/248-501/000-012
	Item no.: 248-501/000-017 Mini-WSB marking card; as card; not stretchable; plain; snap-on type	www.wago.com/248-501/000-017
	Item no.: 248-501/000-023 Mini-WSB marking card; as card; not stretchable; plain; snap-on type	www.wago.com/248-501/000-023



Item no.: 248-501/000-024
Mini-WSB marking card; as card; not stretchable; plain; snap-on type

www.wago.com/248-501/000-024



Item no.: 793-501
WMB marking card; as card; not stretchable; plain; snap-on type

www.wago.com/793-501



Item no.: 793-501/000-002
WMB marking card; as card; not stretchable; plain; snap-on type

www.wago.com/793-501/000-002



Item no.: 793-501/000-005
WMB marking card; as card; not stretchable; plain; snap-on type

www.wago.com/793-501/000-005



Item no.: 793-501/000-006
WMB marking card; as card; not stretchable; plain; snap-on type

www.wago.com/793-501/000-006



Item no.: 793-501/000-007
WMB marking card; as card; not stretchable; plain; snap-on type

www.wago.com/793-501/000-007



Item no.: 793-501/000-012
WMB marking card; as card; not stretchable; plain; snap-on type

www.wago.com/793-501/000-012



Item no.: 793-501/000-017
WMB marking card; as card; not stretchable; plain; snap-on type

www.wago.com/793-501/000-017



Item no.: 793-501/000-023
WMB marking card; as card; not stretchable; plain; snap-on type

www.wago.com/793-501/000-023



Item no.: 793-501/000-024
WMB marking card; as card; not stretchable; plain; snap-on type

www.wago.com/793-501/000-024



Item no.: 793-5501
WMB marking card; as card; for terminal block width 5 - 17.5 mm; stretchable 5 - 5.2 mm; plain; snap-on type

www.wago.com/793-5501



Item no.: 793-5501/000-002
WMB marking card; as card; for terminal block width 5 - 17.5 mm; stretchable 5 - 5.2 mm; plain; snap-on type

www.wago.com/793-5501/000-002



Item no.: 793-5501/000-005
WMB marking card; as card; stretchable 5 - 5.2 mm; plain; snap-on type

www.wago.com/793-5501/000-005



Item no.: 793-5501/000-006
WMB marking card; as card; stretchable 5 - 5.2 mm; plain; snap-on type

www.wago.com/793-5501/000-006



Item no.: 793-5501/000-007
WMB marking card; as card; stretchable 5 - 5.2 mm; plain; snap-on type

www.wago.com/793-5501/000-007



Item no.: 793-5501/000-012
WMB marking card; as card; stretchable 5 - 5.2 mm; plain; snap-on type

www.wago.com/793-5501/000-012



Item no.: 793-5501/000-017
WMB marking card; as card; stretchable 5 - 5.2 mm; plain; snap-on type

www.wago.com/793-5501/000-017



Item no.: 793-5501/000-023
WMB marking card; as card; stretchable 5 - 5.2 mm; plain; snap-on type

www.wago.com/793-5501/000-023



Item no.: 793-5501/000-024
WMB marking card; as card; stretchable 5 - 5.2 mm; plain; snap-on type

www.wago.com/793-5501/000-024

General accessories



Item no.: 2016-100
Finger guard; touchproof cover protects unused conductor entries

www.wago.com/2016-100

check



Item no.: 2009-174
Test plug adapter; for 4 mm Ø test plugs; for testing TOPJOB®S rail-mounted terminal blocks

www.wago.com/2009-174



Item no.: 2009-182
Testing tap; for max. 2.5 mm²; tool-free connection for individual test wires 0.08 - 2.5 mm

www.wago.com/2009-182



Item no.: 2016-511
Modular TOPJOB®S connector; modular; for jumper contact slot; 1-pole

www.wago.com/2016-511



Item no.: 2016-549
Spacer module; modular; e.g., for bridging commoned terminal blocks

www.wago.com/2016-549

Downloads

Documentation

Bid Text

2016-7601	Aug 13, 2018	DOCX 15.1 kB	Download
-----------	--------------	-----------------	----------

smartDATA

CAD data

3D Download 2016-7601	URL	Download
-----------------------	-----	----------



Subject to changes.

WAGO Kontakttechnik GmbH & Co. KG
Hansastr. 27
32423 Minden
Phone: +49571 887-0 | Fax: +49571 887-169
Email: info.de@wago.com | Web: www.wago.com

Do you have any questions about our products?
We are always happy to take your call at +49 (571) 887-44222.