

## Data sheet | Item number: 2022-1201

1-conductor/1-pin carrier terminal block; for DIN-rail 35 x 15 and 35 x 7.5;  
2.5 mm<sup>2</sup>; Push-in CAGE CLAMP®

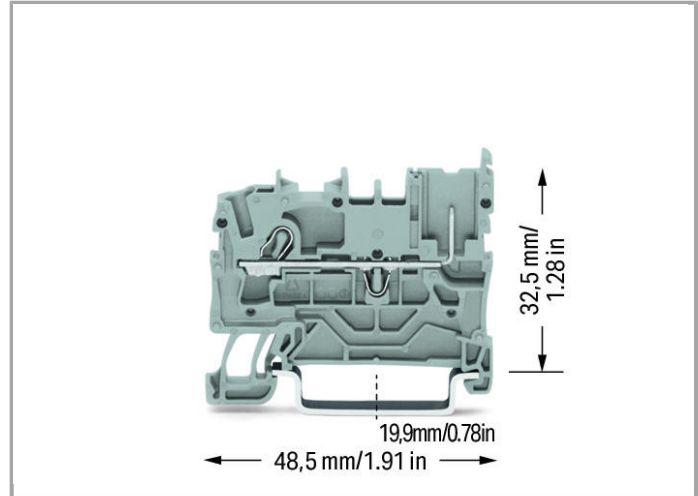

[www.wago.com/2022-1201](http://www.wago.com/2022-1201)

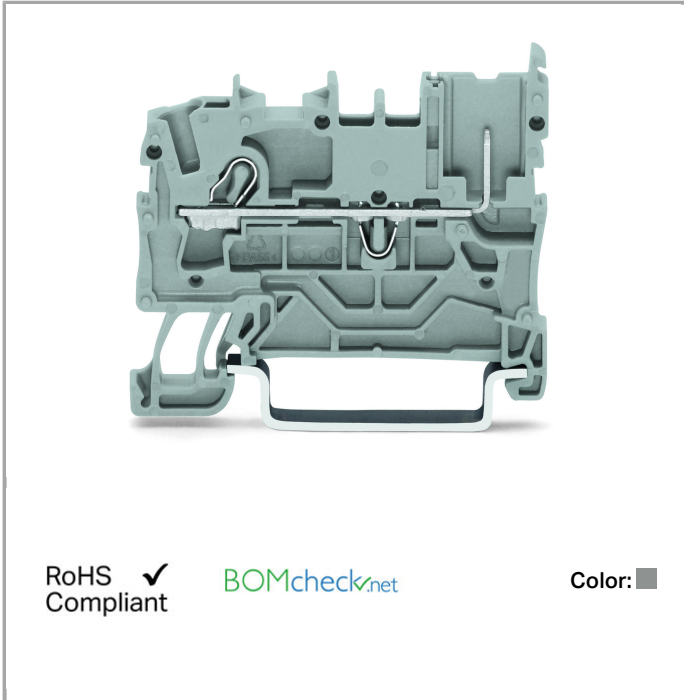

RoHS  Compliant

[BOMcheck.net](https://www.bomcheck.net)

Color: ■

### Data

#### Electrical data

#### Ratings per IEC/EN 60664-1

Rated voltage (III / 3)	690 V
Rated impulse voltage (III / 3)	6 kV
Rated current	24 A
Rated current (2)	32 A
Legend (ratings)	(III / 3) ≙ Overvoltage category III / Pollution degree 3

#### Connection data

Connection technology	Push-in CAGE CLAMP®
Actuation type	Operating tool Push-in
Connectable conductor materials	Copper Aluminum
Nominal cross section	2.5 mm <sup>2</sup>
Solid conductor	0.25 ... 4 mm <sup>2</sup> / 22 ... 12 AWG
Solid conductor, push-in termination	0.75 ... 4 mm <sup>2</sup> / 18 ... 12 AWG

Fine-stranded conductor	0.25 ... 4 mm <sup>2</sup> / 22 ... 12 AWG
Fine-stranded conductor with ferrule, push-in termination, from	0.75 mm <sup>2</sup> / 18 AWG
Strip length	10 ... 12 mm / 0.39 ... 0.47 Inch
Total number of connection points	1
Total number of potentials	1
Number of levels	1
Type of wiring	Front-entry wiring

### Geometrical Data

Width	5.2 mm / 0.205 inch
Height from upper-edge of DIN-35 rail	32.5 mm / 1.28 inch
Depth	48.5 mm / 1.909 inch

### Mechanical data

Design	horizontal
Type of mounting	DIN-35 rail
Marking level	Center/side marking

### Material Data

Color	gray
Insulating material	Polyamide 66 (PA 66)
Fire load	0.112 MJ
Weight	5.038 g

### Commercial data

Country of origin	CN
GTIN	4050821145059
Customs Tariff No.	85366990990
Product Group	18 (X-COM-System)

### Approvals / Certificates

#### Country specific Approvals

Logo	Approval	Certificate name
	CSA DEKRA Certification B.V.	70107915

#### UL-Approvals

Logo	Approval	Certificate name
	UR	E45172



Underwriters Laboratories Inc.

## Compatible products

### Insulation stop



**Item no.: 2002-171**  
Insulation stop; 0.25 - 0.5 mm<sup>2</sup>; 5 pieces/strip

[www.wago.com/2002-171](http://www.wago.com/2002-171)

**Item no.: 2002-172**  
Insulation stop; 0.75 - 1 mm<sup>2</sup>; 5 pieces/strip

[www.wago.com/2002-172](http://www.wago.com/2002-172)

### End plate



**Item no.: 2022-1291**  
End and intermediate plate; 1 mm thick

[www.wago.com/2022-1291](http://www.wago.com/2022-1291)

**Item no.: 2022-1292**  
End and intermediate plate; 1 mm thick

[www.wago.com/2022-1292](http://www.wago.com/2022-1292)

### Protective Warning Marker



**Item no.: 2002-115**  
Protective warning marker; with high-voltage symbol, black; for 5 terminal blocks

[www.wago.com/2002-115](http://www.wago.com/2002-115)

### ferrule



**Item no.: 216-241**  
Ferrule; Sleeve for 0.5 mm<sup>2</sup> / AWG 22; insulated; electro-tin plated; electrolytic copper; gastight crimped; acc. to DIN 46228, Part 4/09.90

[www.wago.com/216-241](http://www.wago.com/216-241)

**Item no.: 216-242**  
Ferrule; Sleeve for 0.75 mm<sup>2</sup> / AWG 20; insulated; electro-tin plated; electrolytic copper; gastight crimped; acc. to DIN 46228, Part 4/09.90

[www.wago.com/216-242](http://www.wago.com/216-242)

**Item no.: 216-243**  
Ferrule; Sleeve for 1 mm<sup>2</sup> / AWG 18; insulated; electro-tin plated; electrolytic copper; gastight crimped; acc. to DIN 46228, Part 4/09.90

[www.wago.com/216-243](http://www.wago.com/216-243)

**Item no.: 216-244**  
Ferrule; Sleeve for 1.5 mm<sup>2</sup> / AWG 16; insulated; electro-tin plated; electrolytic copper; gastight crimped; acc. to DIN 46228, Part 4/09.90

[www.wago.com/216-244](http://www.wago.com/216-244)

**Item no.: 216-246**  
Ferrule; Sleeve for 2.5 mm<sup>2</sup> / AWG 14; insulated; electro-tin plated; electrolytic copper; gastight crimped; acc. to DIN 46228, Part 4/09.90

[www.wago.com/216-246](http://www.wago.com/216-246)

**Item no.: 216-262**  
Ferrule; Sleeve for 0.75 mm<sup>2</sup> / AWG 20; insulated; electro-tin plated; electrolytic copper; gastight crimped; acc. to DIN 46228, Part 4/09.90









[www.wago.com/216-262](http://www.wago.com/216-262)









**Item no.: 216-263**  
Ferrule; Sleeve for 1 mm<sup>2</sup> / AWG 18; insulated; electro-tin plated; electrolytic copper; gastight crimped; acc. to DIN 46228, Part 4/09.90

[www.wago.com/216-263](http://www.wago.com/216-263)

**Item no.: 216-264**  
Ferrule; Sleeve for 1.5 mm<sup>2</sup> / AWG 16; insulated; electro-tin plated; electrolytic copper; gastight crimped; acc. to DIN 46228, Part 4/09.90

[www.wago.com/216-264](http://www.wago.com/216-264)

	<b>Item no.: 216-266</b> Ferrule; Sleeve for 2.5 mm <sup>2</sup> / AWG 14; insulated; electro-tin plated; electrolytic copper; gastight crimped; acc. to DIN 46228, Part 4/09.90	<a href="http://www.wago.com/216-266">www.wago.com/216-266</a>
	<b>Item no.: 216-284</b> Ferrule; Sleeve for 1.5 mm <sup>2</sup> / AWG 16; insulated; electro-tin plated; electrolytic copper; gastight crimped; acc. to DIN 46228, Part 4/09.90	<a href="http://www.wago.com/216-284">www.wago.com/216-284</a>
	<b>Item no.: 216-286</b> Ferrule; Sleeve for 2.5 mm <sup>2</sup> / AWG 14; insulated; electro-tin plated; electrolytic copper; gastight crimped; acc. to DIN 46228, Part 4/09.90	<a href="http://www.wago.com/216-286">www.wago.com/216-286</a>
<b>tools</b>		
	<b>Item no.: 210-720</b> Operating tool with partially insulated shaft; Type 2, blade (3.5 x 0.5) mm	<a href="http://www.wago.com/210-720">www.wago.com/210-720</a>
<b>Female plug</b>		
	<b>Item no.: 2022-101</b> 1-conductor female plug; 2.5 mm <sup>2</sup> ; 1-pole	<a href="http://www.wago.com/2022-101">www.wago.com/2022-101</a>
	<b>Item no.: 2022-101/000-006</b> 1-conductor female plug; 1-pole	<a href="http://www.wago.com/2022-101/000-006">www.wago.com/2022-101/000-006</a>
	<b>Item no.: 2022-101/000-012</b> 1-conductor female plug; 1-pole	<a href="http://www.wago.com/2022-101/000-012">www.wago.com/2022-101/000-012</a>
	<b>Item no.: 2022-101/000-016</b> 1-conductor female plug; 1-pole	<a href="http://www.wago.com/2022-101/000-016">www.wago.com/2022-101/000-016</a>
	<b>Item no.: 2022-101/122-000</b> 1-conductor female plug; 1-pole	<a href="http://www.wago.com/2022-101/122-000">www.wago.com/2022-101/122-000</a>
	<b>Item no.: 2022-101/122-006</b> 1-conductor female plug; 1-pole	<a href="http://www.wago.com/2022-101/122-006">www.wago.com/2022-101/122-006</a>
	<b>Item no.: 2022-101/122-016</b> 1-conductor female plug; 1-pole	<a href="http://www.wago.com/2022-101/122-016">www.wago.com/2022-101/122-016</a>
	<b>Item no.: 2022-101/132-000</b> 1-conductor female plug; Strain relief plate; 1-pole	<a href="http://www.wago.com/2022-101/132-000">www.wago.com/2022-101/132-000</a>
	<b>Item no.: 2022-101/132-006</b> 1-conductor female plug; Strain relief plate; 1-pole	<a href="http://www.wago.com/2022-101/132-006">www.wago.com/2022-101/132-006</a>
	<b>Item no.: 2022-101/132-016</b> 1-conductor female plug; Strain relief plate; 1-pole	<a href="http://www.wago.com/2022-101/132-016">www.wago.com/2022-101/132-016</a>

	<b>Item no.: 2022-101/142-000</b> 1-conductor female plug; Strain relief plate; 1-pole	<a href="http://www.wago.com/2022-101/142-000">www.wago.com/2022-101/142-000</a>
	<b>Item no.: 2022-101/142-006</b> 1-conductor female plug; Strain relief plate; 1-pole	<a href="http://www.wago.com/2022-101/142-006">www.wago.com/2022-101/142-006</a>
	<b>Item no.: 2022-101/142-016</b> 1-conductor female plug; Strain relief plate; 1-pole	<a href="http://www.wago.com/2022-101/142-016">www.wago.com/2022-101/142-016</a>
	<b>Item no.: 2022-102</b> 1-conductor female plug; 2.5 mm <sup>2</sup> ; 2-pole	<a href="http://www.wago.com/2022-102">www.wago.com/2022-102</a>
	<b>Item no.: 2022-102/000-006</b> 1-conductor female plug; 2.5 mm <sup>2</sup> ; 2-pole	<a href="http://www.wago.com/2022-102/000-006">www.wago.com/2022-102/000-006</a>
	<b>Item no.: 2022-102/000-016</b> 1-conductor female plug; 2.5 mm <sup>2</sup> ; 2-pole	<a href="http://www.wago.com/2022-102/000-016">www.wago.com/2022-102/000-016</a>
	<b>Item no.: 2022-102/122-000</b> 1-conductor female plug; Locking lever; 2.5 mm <sup>2</sup> ; 2-pole	<a href="http://www.wago.com/2022-102/122-000">www.wago.com/2022-102/122-000</a>
	<b>Item no.: 2022-102/132-000</b> 1-conductor female plug; Strain relief plate; 2.5 mm <sup>2</sup> ; 2-pole	<a href="http://www.wago.com/2022-102/132-000">www.wago.com/2022-102/132-000</a>
	<b>Item no.: 2022-102/142-000</b> 1-conductor female plug; Strain relief plate; 2.5 mm <sup>2</sup> ; 2-pole	<a href="http://www.wago.com/2022-102/142-000">www.wago.com/2022-102/142-000</a>
	<b>Item no.: 2022-103</b> 1-conductor female plug; 2.5 mm <sup>2</sup> ; 3-pole	<a href="http://www.wago.com/2022-103">www.wago.com/2022-103</a>
	<b>Item no.: 2022-103/000-006</b> 1-conductor female plug; 2.5 mm <sup>2</sup> ; 3-pole	<a href="http://www.wago.com/2022-103/000-006">www.wago.com/2022-103/000-006</a>
	<b>Item no.: 2022-103/000-016</b> 1-conductor female plug; 2.5 mm <sup>2</sup> ; 3-pole	<a href="http://www.wago.com/2022-103/000-016">www.wago.com/2022-103/000-016</a>
	<b>Item no.: 2022-103/000-036</b> 1-conductor female plug; 2.5 mm <sup>2</sup> ; 3-pole	<a href="http://www.wago.com/2022-103/000-036">www.wago.com/2022-103/000-036</a>
	<b>Item no.: 2022-103/000-037</b> 1-conductor female plug; 2.5 mm <sup>2</sup> ; 3-pole	<a href="http://www.wago.com/2022-103/000-037">www.wago.com/2022-103/000-037</a>
	<b>Item no.: 2022-103/000-038</b> 1-conductor female plug; 2.5 mm <sup>2</sup> ; 3-pole	<a href="http://www.wago.com/2022-103/000-038">www.wago.com/2022-103/000-038</a>



**Item no.: 2022-103/000-039**  
1-conductor female plug; 2.5 mm<sup>2</sup>; 3-pole

[www.wago.com/2022-103/000-039](http://www.wago.com/2022-103/000-039)

**Item no.: 2022-103/123-000**  
1-conductor female plug; Locking lever; 2.5 mm<sup>2</sup>; 3-pole

[www.wago.com/2022-103/123-000](http://www.wago.com/2022-103/123-000)

**Item no.: 2022-103/133-000**  
1-conductor female plug; Strain relief plate; 2.5 mm<sup>2</sup>; 3-pole

[www.wago.com/2022-103/133-000](http://www.wago.com/2022-103/133-000)

**Item no.: 2022-103/143-000**  
1-conductor female plug; Strain relief plate; 2.5 mm<sup>2</sup>; 3-pole

[www.wago.com/2022-103/143-000](http://www.wago.com/2022-103/143-000)

**Item no.: 2022-104**  
1-conductor female plug; 2.5 mm<sup>2</sup>; 4-pole

[www.wago.com/2022-104](http://www.wago.com/2022-104)



**Item no.: 2022-104/000-006**  
1-conductor female plug; 2.5 mm<sup>2</sup>; 4-pole

[www.wago.com/2022-104/000-006](http://www.wago.com/2022-104/000-006)



**Item no.: 2022-104/000-016**  
1-conductor female plug; 2.5 mm<sup>2</sup>; 4-pole

[www.wago.com/2022-104/000-016](http://www.wago.com/2022-104/000-016)



**Item no.: 2022-104/000-036**  
1-conductor female plug; 2.5 mm<sup>2</sup>; 4-pole

[www.wago.com/2022-104/000-036](http://www.wago.com/2022-104/000-036)



**Item no.: 2022-104/000-037**  
1-conductor female plug; 2.5 mm<sup>2</sup>; 4-pole

[www.wago.com/2022-104/000-037](http://www.wago.com/2022-104/000-037)



**Item no.: 2022-104/000-038**  
1-conductor female plug; 2.5 mm<sup>2</sup>; 4-pole

[www.wago.com/2022-104/000-038](http://www.wago.com/2022-104/000-038)



**Item no.: 2022-104/000-039**  
1-conductor female plug; 2.5 mm<sup>2</sup>; 4-pole

[www.wago.com/2022-104/000-039](http://www.wago.com/2022-104/000-039)

**Item no.: 2022-104/123-000**  
1-conductor female plug; Locking lever; 2.5 mm<sup>2</sup>; 4-pole

[www.wago.com/2022-104/123-000](http://www.wago.com/2022-104/123-000)

**Item no.: 2022-104/133-000**  
1-conductor female plug; Strain relief plate; 2.5 mm<sup>2</sup>; 4-pole

[www.wago.com/2022-104/133-000](http://www.wago.com/2022-104/133-000)













**Item no.: 2022-104/143-000**  
1-conductor female plug; Strain relief plate; 2.5 mm<sup>2</sup>; 4-pole

[www.wago.com/2022-104/143-000](http://www.wago.com/2022-104/143-000)



**Item no.: 2022-105**  
1-conductor female plug; 2.5 mm<sup>2</sup>; 5-pole

[www.wago.com/2022-105](http://www.wago.com/2022-105)

	<b>Item no.: 2022-105/000-006</b> 1-conductor female plug; 2.5 mm <sup>2</sup> ; 5-pole	<a href="http://www.wago.com/2022-105/000-006">www.wago.com/2022-105/000-006</a>
	<b>Item no.: 2022-105/000-016</b> 1-conductor female plug; 2.5 mm <sup>2</sup> ; 5-pole	<a href="http://www.wago.com/2022-105/000-016">www.wago.com/2022-105/000-016</a>
	<b>Item no.: 2022-105/000-036</b> 1-conductor female plug; 2.5 mm <sup>2</sup> ; 5-pole	<a href="http://www.wago.com/2022-105/000-036">www.wago.com/2022-105/000-036</a>
	<b>Item no.: 2022-105/000-037</b> 1-conductor female plug; 2.5 mm <sup>2</sup> ; 5-pole	<a href="http://www.wago.com/2022-105/000-037">www.wago.com/2022-105/000-037</a>
	<b>Item no.: 2022-105/000-038</b> 1-conductor female plug; 2.5 mm <sup>2</sup> ; 5-pole	<a href="http://www.wago.com/2022-105/000-038">www.wago.com/2022-105/000-038</a>
	<b>Item no.: 2022-105/000-039</b> 1-conductor female plug; 2.5 mm <sup>2</sup> ; 5-pole	<a href="http://www.wago.com/2022-105/000-039">www.wago.com/2022-105/000-039</a>
	<b>Item no.: 2022-105/123-000</b> 1-conductor female plug; Locking lever; 2.5 mm <sup>2</sup> ; 5-pole	<a href="http://www.wago.com/2022-105/123-000">www.wago.com/2022-105/123-000</a>
	<b>Item no.: 2022-105/134-000</b> 1-conductor female plug; Strain relief plate; 2.5 mm <sup>2</sup> ; 5-pole	<a href="http://www.wago.com/2022-105/134-000">www.wago.com/2022-105/134-000</a>
	<b>Item no.: 2022-105/144-000</b> 1-conductor female plug; Strain relief plate; 2.5 mm <sup>2</sup> ; 5-pole	<a href="http://www.wago.com/2022-105/144-000">www.wago.com/2022-105/144-000</a>
	<b>Item no.: 2022-106</b> 1-conductor female plug; 2.5 mm <sup>2</sup> ; 6-pole	<a href="http://www.wago.com/2022-106">www.wago.com/2022-106</a>
	<b>Item no.: 2022-106/000-006</b> 1-conductor female plug; 2.5 mm <sup>2</sup> ; 6-pole	<a href="http://www.wago.com/2022-106/000-006">www.wago.com/2022-106/000-006</a>
	<b>Item no.: 2022-106/000-016</b> 1-conductor female plug; 2.5 mm <sup>2</sup> ; 6-pole	<a href="http://www.wago.com/2022-106/000-016">www.wago.com/2022-106/000-016</a>
	<b>Item no.: 2022-106/000-036</b> 1-conductor female plug; 2.5 mm <sup>2</sup> ; 6-pole	<a href="http://www.wago.com/2022-106/000-036">www.wago.com/2022-106/000-036</a>
	<b>Item no.: 2022-106/000-037</b> 1-conductor female plug; 2.5 mm <sup>2</sup> ; 6-pole	<a href="http://www.wago.com/2022-106/000-037">www.wago.com/2022-106/000-037</a>
	<b>Item no.: 2022-106/000-038</b> 1-conductor female plug; 2.5 mm <sup>2</sup> ; 6-pole	<a href="http://www.wago.com/2022-106/000-038">www.wago.com/2022-106/000-038</a>



**Item no.: 2022-106/000-039**  
1-conductor female plug; 2.5 mm<sup>2</sup>; 6-pole

[www.wago.com/2022-106/000-039](http://www.wago.com/2022-106/000-039)

**Item no.: 2022-106/123-000**  
1-conductor female plug; Locking lever; 2.5 mm<sup>2</sup>; 6-pole

[www.wago.com/2022-106/123-000](http://www.wago.com/2022-106/123-000)

**Item no.: 2022-106/134-000**  
1-conductor female plug; Strain relief plate; 2.5 mm<sup>2</sup>; 6-pole

[www.wago.com/2022-106/134-000](http://www.wago.com/2022-106/134-000)

**Item no.: 2022-106/144-000**  
1-conductor female plug; Strain relief plate; 2.5 mm<sup>2</sup>; 6-pole

[www.wago.com/2022-106/144-000](http://www.wago.com/2022-106/144-000)

**Item no.: 2022-107**  
1-conductor female plug; 2.5 mm<sup>2</sup>; 7-pole

[www.wago.com/2022-107](http://www.wago.com/2022-107)



**Item no.: 2022-107/000-006**  
1-conductor female plug; 2.5 mm<sup>2</sup>; 7-pole

[www.wago.com/2022-107/000-006](http://www.wago.com/2022-107/000-006)



**Item no.: 2022-107/000-016**  
1-conductor female plug; 2.5 mm<sup>2</sup>; 7-pole

[www.wago.com/2022-107/000-016](http://www.wago.com/2022-107/000-016)



**Item no.: 2022-107/000-036**  
1-conductor female plug; 2.5 mm<sup>2</sup>; 7-pole

[www.wago.com/2022-107/000-036](http://www.wago.com/2022-107/000-036)



**Item no.: 2022-107/000-037**  
1-conductor female plug; 2.5 mm<sup>2</sup>; 7-pole

[www.wago.com/2022-107/000-037](http://www.wago.com/2022-107/000-037)



**Item no.: 2022-107/000-038**  
1-conductor female plug; 2.5 mm<sup>2</sup>; 7-pole

[www.wago.com/2022-107/000-038](http://www.wago.com/2022-107/000-038)

**Item no.: 2022-107/000-039**  
1-conductor female plug; 2.5 mm<sup>2</sup>; 7-pole

[www.wago.com/2022-107/000-039](http://www.wago.com/2022-107/000-039)

**Item no.: 2022-107/123-000**  
1-conductor female plug; Locking lever; 2.5 mm<sup>2</sup>; 7-pole

[www.wago.com/2022-107/123-000](http://www.wago.com/2022-107/123-000)

**Item no.: 2022-107/135-000**  
1-conductor female plug; Strain relief plate; 2.5 mm<sup>2</sup>; 7-pole

[www.wago.com/2022-107/135-000](http://www.wago.com/2022-107/135-000)

**Item no.: 2022-107/145-000**  
1-conductor female plug; Strain relief plate; 2.5 mm<sup>2</sup>; 7-pole

[www.wago.com/2022-107/145-000](http://www.wago.com/2022-107/145-000)

**Item no.: 2022-108**  
1-conductor female plug; 2.5 mm<sup>2</sup>; 8-pole

[www.wago.com/2022-108](http://www.wago.com/2022-108)





**Item no.: 2022-108/000-006**  
1-conductor female plug; 2.5 mm<sup>2</sup>; 8-pole

[www.wago.com/2022-108/000-006](http://www.wago.com/2022-108/000-006)



**Item no.: 2022-108/000-016**  
1-conductor female plug; 2.5 mm<sup>2</sup>; 8-pole

[www.wago.com/2022-108/000-016](http://www.wago.com/2022-108/000-016)



**Item no.: 2022-108/000-036**  
1-conductor female plug; 2.5 mm<sup>2</sup>; 8-pole

[www.wago.com/2022-108/000-036](http://www.wago.com/2022-108/000-036)

**Item no.: 2022-108/000-037**  
1-conductor female plug; 2.5 mm<sup>2</sup>; 8-pole

[www.wago.com/2022-108/000-037](http://www.wago.com/2022-108/000-037)



**Item no.: 2022-108/000-038**  
1-conductor female plug; 2.5 mm<sup>2</sup>; 8-pole

[www.wago.com/2022-108/000-038](http://www.wago.com/2022-108/000-038)

**Item no.: 2022-108/000-039**  
1-conductor female plug; 2.5 mm<sup>2</sup>; 8-pole

[www.wago.com/2022-108/000-039](http://www.wago.com/2022-108/000-039)

**Item no.: 2022-108/123-000**  
1-conductor female plug; Locking lever; 2.5 mm<sup>2</sup>; 8-pole

[www.wago.com/2022-108/123-000](http://www.wago.com/2022-108/123-000)

**Item no.: 2022-108/135-000**  
1-conductor female plug; Strain relief plate; 2.5 mm<sup>2</sup>; 8-pole

[www.wago.com/2022-108/135-000](http://www.wago.com/2022-108/135-000)

**Item no.: 2022-108/145-000**  
1-conductor female plug; Strain relief plate; 2.5 mm<sup>2</sup>; 8-pole

[www.wago.com/2022-108/145-000](http://www.wago.com/2022-108/145-000)

**Item no.: 2022-109**  
1-conductor female plug; 2.5 mm<sup>2</sup>; 9-pole

[www.wago.com/2022-109](http://www.wago.com/2022-109)



**Item no.: 2022-109/000-006**  
1-conductor female plug; 2.5 mm<sup>2</sup>; 9-pole

[www.wago.com/2022-109/000-006](http://www.wago.com/2022-109/000-006)



**Item no.: 2022-109/000-016**  
1-conductor female plug; 2.5 mm<sup>2</sup>; 9-pole

[www.wago.com/2022-109/000-016](http://www.wago.com/2022-109/000-016)



**Item no.: 2022-109/000-036**  
1-conductor female plug; 2.5 mm<sup>2</sup>; 9-pole

[www.wago.com/2022-109/000-036](http://www.wago.com/2022-109/000-036)



**Item no.: 2022-109/000-037**  
1-conductor female plug; 2.5 mm<sup>2</sup>; 9-pole

[www.wago.com/2022-109/000-037](http://www.wago.com/2022-109/000-037)



**Item no.: 2022-109/000-038**  
1-conductor female plug; 2.5 mm<sup>2</sup>; 9-pole

[www.wago.com/2022-109/000-038](http://www.wago.com/2022-109/000-038)



**Item no.: 2022-109/000-039**  
1-conductor female plug; 2.5 mm<sup>2</sup>; 9-pole

[www.wago.com/2022-109/000-039](http://www.wago.com/2022-109/000-039)

**Item no.: 2022-109/123-000**  
1-conductor female plug; Locking lever; 2.5 mm<sup>2</sup>; 9-pole

[www.wago.com/2022-109/123-000](http://www.wago.com/2022-109/123-000)

**Item no.: 2022-109/135-000**  
1-conductor female plug; Strain relief plate; 2.5 mm<sup>2</sup>; 9-pole

[www.wago.com/2022-109/135-000](http://www.wago.com/2022-109/135-000)

**Item no.: 2022-109/145-000**  
1-conductor female plug; Strain relief plate; 2.5 mm<sup>2</sup>; 9-pole

[www.wago.com/2022-109/145-000](http://www.wago.com/2022-109/145-000)

**Item no.: 2022-110**  
1-conductor female plug; 2.5 mm<sup>2</sup>; 10-pole

[www.wago.com/2022-110](http://www.wago.com/2022-110)



**Item no.: 2022-110/000-006**  
1-conductor female plug; 2.5 mm<sup>2</sup>; 10-pole

[www.wago.com/2022-110/000-006](http://www.wago.com/2022-110/000-006)



**Item no.: 2022-110/000-016**  
1-conductor female plug; 2.5 mm<sup>2</sup>; 10-pole

[www.wago.com/2022-110/000-016](http://www.wago.com/2022-110/000-016)



**Item no.: 2022-110/000-036**  
1-conductor female plug; 2.5 mm<sup>2</sup>; 10-pole

[www.wago.com/2022-110/000-036](http://www.wago.com/2022-110/000-036)

**Item no.: 2022-110/000-037**  
1-conductor female plug; 2.5 mm<sup>2</sup>; 10-pole

[www.wago.com/2022-110/000-037](http://www.wago.com/2022-110/000-037)



**Item no.: 2022-110/000-038**  
1-conductor female plug; 2.5 mm<sup>2</sup>; 10-pole

[www.wago.com/2022-110/000-038](http://www.wago.com/2022-110/000-038)

**Item no.: 2022-110/000-039**  
1-conductor female plug; 2.5 mm<sup>2</sup>; 10-pole

[www.wago.com/2022-110/000-039](http://www.wago.com/2022-110/000-039)

**Item no.: 2022-110/123-000**  
1-conductor female plug; Locking lever; 2.5 mm<sup>2</sup>; 10-pole

[www.wago.com/2022-110/123-000](http://www.wago.com/2022-110/123-000)

**Item no.: 2022-110/135-000**  
1-conductor female plug; Strain relief plate; 2.5 mm<sup>2</sup>; 10-pole

[www.wago.com/2022-110/135-000](http://www.wago.com/2022-110/135-000)

**Item no.: 2022-110/145-000**  
1-conductor female plug; Strain relief plate; 2.5 mm<sup>2</sup>; 10-pole

[www.wago.com/2022-110/145-000](http://www.wago.com/2022-110/145-000)

**Item no.: 2022-111**  
1-conductor female plug; 2.5 mm<sup>2</sup>; 11-pole

[www.wago.com/2022-111](http://www.wago.com/2022-111)



**Item no.: 2022-111/000-006**  
1-conductor female plug; 2.5 mm<sup>2</sup>; 11-pole

[www.wago.com/2022-111/000-006](http://www.wago.com/2022-111/000-006)



**Item no.: 2022-111/000-016**  
1-conductor female plug; 2.5 mm<sup>2</sup>; 11-pole

[www.wago.com/2022-111/000-016](http://www.wago.com/2022-111/000-016)



**Item no.: 2022-111/000-036**  
1-conductor female plug; 2.5 mm<sup>2</sup>; 11-pole

[www.wago.com/2022-111/000-036](http://www.wago.com/2022-111/000-036)

**Item no.: 2022-111/000-037**  
1-conductor female plug; 2.5 mm<sup>2</sup>; 11-pole

[www.wago.com/2022-111/000-037](http://www.wago.com/2022-111/000-037)



**Item no.: 2022-111/000-038**  
1-conductor female plug; 2.5 mm<sup>2</sup>; 11-pole

[www.wago.com/2022-111/000-038](http://www.wago.com/2022-111/000-038)

**Item no.: 2022-111/000-039**  
1-conductor female plug; 2.5 mm<sup>2</sup>; 11-pole

[www.wago.com/2022-111/000-039](http://www.wago.com/2022-111/000-039)

**Item no.: 2022-111/126-000**  
1-conductor female plug; Locking lever; 2.5 mm<sup>2</sup>; 11-pole

[www.wago.com/2022-111/126-000](http://www.wago.com/2022-111/126-000)

**Item no.: 2022-111/136-000**  
1-conductor female plug; Strain relief plate; 2.5 mm<sup>2</sup>; 11-pole

[www.wago.com/2022-111/136-000](http://www.wago.com/2022-111/136-000)

**Item no.: 2022-111/146-000**  
1-conductor female plug; Strain relief plate; 2.5 mm<sup>2</sup>; 11-pole

[www.wago.com/2022-111/146-000](http://www.wago.com/2022-111/146-000)

**Item no.: 2022-112**  
1-conductor female plug; 2.5 mm<sup>2</sup>; 12-pole

[www.wago.com/2022-112](http://www.wago.com/2022-112)



**Item no.: 2022-112/000-006**  
1-conductor female plug; 2.5 mm<sup>2</sup>; 12-pole

[www.wago.com/2022-112/000-006](http://www.wago.com/2022-112/000-006)



**Item no.: 2022-112/000-016**  
1-conductor female plug; 2.5 mm<sup>2</sup>; 12-pole

[www.wago.com/2022-112/000-016](http://www.wago.com/2022-112/000-016)



**Item no.: 2022-112/000-036**  
1-conductor female plug; 2.5 mm<sup>2</sup>; 12-pole

[www.wago.com/2022-112/000-036](http://www.wago.com/2022-112/000-036)



**Item no.: 2022-112/000-037**  
1-conductor female plug; 2.5 mm<sup>2</sup>; 12-pole

[www.wago.com/2022-112/000-037](http://www.wago.com/2022-112/000-037)



**Item no.: 2022-112/000-038**  
1-conductor female plug; 2.5 mm<sup>2</sup>; 12-pole

[www.wago.com/2022-112/000-038](http://www.wago.com/2022-112/000-038)



**Item no.: 2022-112/000-039**  
1-conductor female plug; 2.5 mm<sup>2</sup>; 12-pole

[www.wago.com/2022-112/000-039](http://www.wago.com/2022-112/000-039)

**Item no.: 2022-112/126-000**  
1-conductor female plug; Locking lever; 2.5 mm<sup>2</sup>; 12-pole

[www.wago.com/2022-112/126-000](http://www.wago.com/2022-112/126-000)

**Item no.: 2022-112/136-000**  
1-conductor female plug; Strain relief plate; 2.5 mm<sup>2</sup>; 12-pole

[www.wago.com/2022-112/136-000](http://www.wago.com/2022-112/136-000)

**Item no.: 2022-112/146-000**  
1-conductor female plug; Strain relief plate; 2.5 mm<sup>2</sup>; 12-pole

[www.wago.com/2022-112/146-000](http://www.wago.com/2022-112/146-000)

**Item no.: 2022-113**  
1-conductor female plug; 2.5 mm<sup>2</sup>; 13-pole

[www.wago.com/2022-113](http://www.wago.com/2022-113)



**Item no.: 2022-113/000-006**  
1-conductor female plug; 2.5 mm<sup>2</sup>; 13-pole

[www.wago.com/2022-113/000-006](http://www.wago.com/2022-113/000-006)



**Item no.: 2022-113/000-016**  
1-conductor female plug; 2.5 mm<sup>2</sup>; 13-pole

[www.wago.com/2022-113/000-016](http://www.wago.com/2022-113/000-016)



**Item no.: 2022-113/000-036**  
1-conductor female plug; 2.5 mm<sup>2</sup>; 13-pole

[www.wago.com/2022-113/000-036](http://www.wago.com/2022-113/000-036)

**Item no.: 2022-113/000-037**  
1-conductor female plug; 2.5 mm<sup>2</sup>; 13-pole

[www.wago.com/2022-113/000-037](http://www.wago.com/2022-113/000-037)



**Item no.: 2022-113/000-038**  
1-conductor female plug; 2.5 mm<sup>2</sup>; 13-pole

[www.wago.com/2022-113/000-038](http://www.wago.com/2022-113/000-038)

**Item no.: 2022-113/000-039**  
1-conductor female plug; 2.5 mm<sup>2</sup>; 13-pole

[www.wago.com/2022-113/000-039](http://www.wago.com/2022-113/000-039)

**Item no.: 2022-113/126-000**  
1-conductor female plug; Locking lever; 2.5 mm<sup>2</sup>; 13-pole

[www.wago.com/2022-113/126-000](http://www.wago.com/2022-113/126-000)

**Item no.: 2022-113/136-000**  
1-conductor female plug; Strain relief plate; 2.5 mm<sup>2</sup>; 13-pole

[www.wago.com/2022-113/136-000](http://www.wago.com/2022-113/136-000)

**Item no.: 2022-113/146-000**  
1-conductor female plug; Strain relief plate; 2.5 mm<sup>2</sup>; 13-pole

[www.wago.com/2022-113/146-000](http://www.wago.com/2022-113/146-000)

**Item no.: 2022-114**  
1-conductor female plug; 2.5 mm<sup>2</sup>; 14-pole

[www.wago.com/2022-114](http://www.wago.com/2022-114)



**Item no.: 2022-114/000-006**  
1-conductor female plug; 2.5 mm<sup>2</sup>; 14-pole

[www.wago.com/2022-114/000-006](http://www.wago.com/2022-114/000-006)



**Item no.: 2022-114/000-016**  
1-conductor female plug; 2.5 mm<sup>2</sup>; 14-pole

[www.wago.com/2022-114/000-016](http://www.wago.com/2022-114/000-016)



**Item no.: 2022-114/000-036**  
1-conductor female plug; 2.5 mm<sup>2</sup>; 14-pole

[www.wago.com/2022-114/000-036](http://www.wago.com/2022-114/000-036)

**Item no.: 2022-114/000-037**  
1-conductor female plug; 2.5 mm<sup>2</sup>; 14-pole

[www.wago.com/2022-114/000-037](http://www.wago.com/2022-114/000-037)



**Item no.: 2022-114/000-038**  
1-conductor female plug; 2.5 mm<sup>2</sup>; 14-pole

[www.wago.com/2022-114/000-038](http://www.wago.com/2022-114/000-038)

**Item no.: 2022-114/000-039**  
1-conductor female plug; 2.5 mm<sup>2</sup>; 14-pole

[www.wago.com/2022-114/000-039](http://www.wago.com/2022-114/000-039)

**Item no.: 2022-114/126-000**  
1-conductor female plug; Locking lever; 2.5 mm<sup>2</sup>; 14-pole

[www.wago.com/2022-114/126-000](http://www.wago.com/2022-114/126-000)

**Item no.: 2022-114/136-000**  
1-conductor female plug; Strain relief plate; 2.5 mm<sup>2</sup>; 14-pole

[www.wago.com/2022-114/136-000](http://www.wago.com/2022-114/136-000)

**Item no.: 2022-114/146-000**  
1-conductor female plug; Strain relief plate; 2.5 mm<sup>2</sup>; 14-pole

[www.wago.com/2022-114/146-000](http://www.wago.com/2022-114/146-000)

**Item no.: 2022-115**  
1-conductor female plug; 2.5 mm<sup>2</sup>; 15-pole

[www.wago.com/2022-115](http://www.wago.com/2022-115)



**Item no.: 2022-115/000-006**  
1-conductor female plug; 2.5 mm<sup>2</sup>; 15-pole

[www.wago.com/2022-115/000-006](http://www.wago.com/2022-115/000-006)



**Item no.: 2022-115/000-016**  
1-conductor female plug; 2.5 mm<sup>2</sup>; 15-pole

[www.wago.com/2022-115/000-016](http://www.wago.com/2022-115/000-016)



**Item no.: 2022-115/000-036**  
1-conductor female plug; 2.5 mm<sup>2</sup>; 15-pole

[www.wago.com/2022-115/000-036](http://www.wago.com/2022-115/000-036)

**Item no.: 2022-115/000-037**  
1-conductor female plug; 2.5 mm<sup>2</sup>; 15-pole

[www.wago.com/2022-115/000-037](http://www.wago.com/2022-115/000-037)



**Item no.: 2022-115/000-038**  
1-conductor female plug; 2.5 mm<sup>2</sup>; 15-pole

[www.wago.com/2022-115/000-038](http://www.wago.com/2022-115/000-038)

**Item no.: 2022-115/000-039**  
1-conductor female plug; 2.5 mm<sup>2</sup>; 15-pole

[www.wago.com/2022-115/000-039](http://www.wago.com/2022-115/000-039)

**Item no.: 2022-115/127-000**  
1-conductor female plug; Locking lever; 2.5 mm<sup>2</sup>; 15-pole

[www.wago.com/2022-115/127-000](http://www.wago.com/2022-115/127-000)

**Item no.: 2022-115/137-000**  
1-conductor female plug; Strain relief plate; 2.5 mm<sup>2</sup>; 15-pole

[www.wago.com/2022-115/137-000](http://www.wago.com/2022-115/137-000)

**Item no.: 2022-115/147-000**  
1-conductor female plug; Strain relief plate; 2.5 mm<sup>2</sup>; 15-pole

[www.wago.com/2022-115/147-000](http://www.wago.com/2022-115/147-000)

## Jumper

 **Item no.: 2002-400**  
Adjacent jumper for continuous commoning; insulated; 2-way; Nominal current 25 A

[www.wago.com/2002-400](http://www.wago.com/2002-400)

 **Item no.: 2002-402**  
Push-in type jumper bar; insulated; 2-way; Nominal current 25 A

[www.wago.com/2002-402](http://www.wago.com/2002-402)

 **Item no.: 2002-402/000-005**  
Push-in type jumper bar; insulated; 2-way; Nominal current 25 A

[www.wago.com/2002-402/000-005](http://www.wago.com/2002-402/000-005)

 **Item no.: 2002-402/000-006**  
Push-in type jumper bar; insulated; 2-way; Nominal current 25 A

[www.wago.com/2002-402/000-006](http://www.wago.com/2002-402/000-006)

 **Item no.: 2002-403**  
Push-in type jumper bar; insulated; 3-way; Nominal current 25 A

[www.wago.com/2002-403](http://www.wago.com/2002-403)

 **Item no.: 2002-403/000-005**  
Push-in type jumper bar; insulated; 3-way; Nominal current 25 A

[www.wago.com/2002-403/000-005](http://www.wago.com/2002-403/000-005)

 **Item no.: 2002-403/000-006**  
Push-in type jumper bar; insulated; 3-way; Nominal current 25 A

[www.wago.com/2002-403/000-006](http://www.wago.com/2002-403/000-006)

 **Item no.: 2002-404**  
Push-in type jumper bar; insulated; 4-way; Nominal current 25 A

[www.wago.com/2002-404](http://www.wago.com/2002-404)

 **Item no.: 2002-404/000-005**  
Push-in type jumper bar; insulated; 4-way; Nominal current 25 A

















[www.wago.com/2002-404/000-005](http://www.wago.com/2002-404/000-005)

















 **Item no.: 2002-404/000-006**  
Push-in type jumper bar; insulated; 4-way; Nominal current 25 A

[www.wago.com/2002-404/000-006](http://www.wago.com/2002-404/000-006)

















 **Item no.: 2002-405**  
Push-in type jumper bar; insulated; 5-way; Nominal current 25 A

[www.wago.com/2002-405](http://www.wago.com/2002-405)

	<p><b>Item no.: 2002-405/000-005</b>                      Push-in type jumper bar; insulated; 5-way; Nominal current 25 A</p>	<a href="http://www.wago.com/2002-405/000-005">www.wago.com/2002-405/000-005</a>
	<p><b>Item no.: 2002-405/000-006</b>                      Push-in type jumper bar; insulated; 5-way; Nominal current 25 A</p>	<a href="http://www.wago.com/2002-405/000-006">www.wago.com/2002-405/000-006</a>
	<p><b>Item no.: 2002-405/011-000</b>                      Star point jumper; insulated; 3-way (1-3-5); IN = IN terminal block</p>	<a href="http://www.wago.com/2002-405/011-000">www.wago.com/2002-405/011-000</a>
	<p><b>Item no.: 2002-406</b>                      Push-in type jumper bar; insulated; 6-way; Nominal current 25 A</p>	<a href="http://www.wago.com/2002-406">www.wago.com/2002-406</a>
	<p><b>Item no.: 2002-406/000-005</b>                      Push-in type jumper bar; insulated; 6-way; Nominal current 25 A</p>	<a href="http://www.wago.com/2002-406/000-005">www.wago.com/2002-406/000-005</a>
	<p><b>Item no.: 2002-406/000-006</b>                      Push-in type jumper bar; insulated; 6-way; Nominal current 25 A</p>	<a href="http://www.wago.com/2002-406/000-006">www.wago.com/2002-406/000-006</a>
	<p><b>Item no.: 2002-406/020-000</b>                      Delta jumper; insulated; 1-2 3-4 5-6; IN = IN terminal block</p>	<a href="http://www.wago.com/2002-406/020-000">www.wago.com/2002-406/020-000</a>
	<p><b>Item no.: 2002-407</b>                      Push-in type jumper bar; insulated; 7-way; Nominal current 25 A</p>	<a href="http://www.wago.com/2002-407">www.wago.com/2002-407</a>
	<p><b>Item no.: 2002-407/000-005</b>                      Push-in type jumper bar; insulated; 7-way; Nominal current 25 A</p>	<a href="http://www.wago.com/2002-407/000-005">www.wago.com/2002-407/000-005</a>
	<p><b>Item no.: 2002-407/000-006</b>                      Push-in type jumper bar; insulated; 7-way; Nominal current 25 A</p>	<a href="http://www.wago.com/2002-407/000-006">www.wago.com/2002-407/000-006</a>
	<p><b>Item no.: 2002-408</b>                      Push-in type jumper bar; insulated; 8-way; Nominal current 25 A</p>	<a href="http://www.wago.com/2002-408">www.wago.com/2002-408</a>
	<p><b>Item no.: 2002-408/000-005</b>                      Push-in type jumper bar; insulated; 8-way; Nominal current 25 A</p>	<a href="http://www.wago.com/2002-408/000-005">www.wago.com/2002-408/000-005</a>
	<p><b>Item no.: 2002-408/000-006</b>                      Push-in type jumper bar; insulated; 8-way; Nominal current 25 A</p>	<a href="http://www.wago.com/2002-408/000-006">www.wago.com/2002-408/000-006</a>
	<p><b>Item no.: 2002-409</b>                      Push-in type jumper bar; insulated; 9-way; Nominal current 25 A</p>	<a href="http://www.wago.com/2002-409">www.wago.com/2002-409</a>
	<p><b>Item no.: 2002-409/000-005</b>                      Push-in type jumper bar; insulated; 9-way; Nominal current 25 A</p>	<a href="http://www.wago.com/2002-409/000-005">www.wago.com/2002-409/000-005</a>
	<p><b>Item no.: 2002-409/000-006</b>                      Push-in type jumper bar; insulated; 9-way; Nominal current 25 A</p>	<a href="http://www.wago.com/2002-409/000-006">www.wago.com/2002-409/000-006</a>

	<b>Item no.: 2002-410</b> Push-in type jumper bar; insulated; 10-way; Nominal current 25 A	<a href="http://www.wago.com/2002-410">www.wago.com/2002-410</a>
	<b>Item no.: 2002-410/000-005</b> Push-in type jumper bar; insulated; 10-way; Nominal current 25 A	<a href="http://www.wago.com/2002-410/000-005">www.wago.com/2002-410/000-005</a>
	<b>Item no.: 2002-410/000-006</b> Push-in type jumper bar; insulated; 10-way; Nominal current 25 A	<a href="http://www.wago.com/2002-410/000-006">www.wago.com/2002-410/000-006</a>
	<b>Item no.: 2002-423</b> Push-in type jumper bar; insulated; from 1 to 3; Nominal current 25 A	<a href="http://www.wago.com/2002-423">www.wago.com/2002-423</a>
	<b>Item no.: 2002-423/000-005</b> Adjacent jumper for continuous commoning; insulated; from 1 to 3; Nominal current 25 A	<a href="http://www.wago.com/2002-423/000-005">www.wago.com/2002-423/000-005</a>
	<b>Item no.: 2002-423/000-006</b> Adjacent jumper for continuous commoning; insulated; from 1 to 3; Nominal current 25 A	<a href="http://www.wago.com/2002-423/000-006">www.wago.com/2002-423/000-006</a>
	<b>Item no.: 2002-433</b> Push-in type jumper bar; insulated; from 1 to 3; Nominal current 25 A	<a href="http://www.wago.com/2002-433">www.wago.com/2002-433</a>
	<b>Item no.: 2002-434</b> Push-in type jumper bar; insulated; from 1 to 4; Nominal current 25 A	<a href="http://www.wago.com/2002-434">www.wago.com/2002-434</a>
	<b>Item no.: 2002-435</b> Push-in type jumper bar; insulated; from 1 to 5; Nominal current 25 A	<a href="http://www.wago.com/2002-435">www.wago.com/2002-435</a>
	<b>Item no.: 2002-436</b> Push-in type jumper bar; insulated; from 1 to 6; Nominal current 25 A	<a href="http://www.wago.com/2002-436">www.wago.com/2002-436</a>
	<b>Item no.: 2002-437</b> Push-in type jumper bar; insulated; from 1 to 7; Nominal current 25 A	<a href="http://www.wago.com/2002-437">www.wago.com/2002-437</a>
	<b>Item no.: 2002-438</b> Push-in type jumper bar; insulated; from 1 to 8; Nominal current 25 A	<a href="http://www.wago.com/2002-438">www.wago.com/2002-438</a>
	<b>Item no.: 2002-439</b> Push-in type jumper bar; insulated; from 1 to 9; Nominal current 25 A	<a href="http://www.wago.com/2002-439">www.wago.com/2002-439</a>
	<b>Item no.: 2002-440</b> Push-in type jumper bar; insulated; from 1 to 10; Nominal current 25 A	<a href="http://www.wago.com/2002-440">www.wago.com/2002-440</a>
	<b>Item no.: 2002-472</b> Staggered jumper; insulated; 2-way; Nominal current 25 A; suitable for 2002 and 2003 Series rail-mounted terminal blocks	<a href="http://www.wago.com/2002-472">www.wago.com/2002-472</a>
	<b>Item no.: 2002-473</b> Staggered jumper; insulated; 3-way; Nominal current 25 A; suitable for 2002 and 2003 Series rail-mounted terminal blocks	<a href="http://www.wago.com/2002-473">www.wago.com/2002-473</a>
	<b>Item no.: 2002-473/011-000</b> Ready-made staggered jumper; insulated; 2-way (1-3); Nominal current 25 A; with contact lugs broken off at the factory and circuit marking	<a href="http://www.wago.com/2002-473/011-000">www.wago.com/2002-473/011-000</a>
	<b>Item no.: 2002-474</b>	



	Staggered jumper; insulated; 4-way; Nominal current 25 A; suitable for 2002 and 2003 Series rail-mounted terminal blocks	<a href="http://www.wago.com/2002-474">www.wago.com/2002-474</a>
	<b>Item no.: 2002-475</b> Staggered jumper; insulated; 5-way; Nominal current 25 A; suitable for 2002 and 2003 Series rail-mounted terminal blocks	<a href="http://www.wago.com/2002-475">www.wago.com/2002-475</a>
	<b>Item no.: 2002-475/011-000</b> Ready-made staggered jumper; insulated; 3-way (1-3-5); Nominal current 25 A; with contact lugs broken off at the factory and circuit marking	<a href="http://www.wago.com/2002-475/011-000">www.wago.com/2002-475/011-000</a>
	<b>Item no.: 2002-476</b> Staggered jumper; insulated; 6-way; Nominal current 25 A; suitable for 2002 and 2003 Series rail-mounted terminal blocks	<a href="http://www.wago.com/2002-476">www.wago.com/2002-476</a>
	<b>Item no.: 2002-477</b> Staggered jumper; insulated; 7-way; Nominal current 25 A; suitable for 2002 and 2003 Series rail-mounted terminal blocks	<a href="http://www.wago.com/2002-477">www.wago.com/2002-477</a>
	<b>Item no.: 2002-477/011-000</b> Ready-made staggered jumper; insulated; 1-3-5-7; Nominal current 25 A; with contact lugs broken off at the factory and circuit marking	<a href="http://www.wago.com/2002-477/011-000">www.wago.com/2002-477/011-000</a>
	<b>Item no.: 2002-478</b> Staggered jumper; insulated; 8-way; Nominal current 25 A; suitable for 2002 and 2003 Series rail-mounted terminal blocks	<a href="http://www.wago.com/2002-478">www.wago.com/2002-478</a>
	<b>Item no.: 2002-479</b> Staggered jumper; insulated; 9-way; Nominal current 25 A; suitable for 2002 and 2003 Series rail-mounted terminal blocks	<a href="http://www.wago.com/2002-479">www.wago.com/2002-479</a>
	<b>Item no.: 2002-479/011-000</b> Ready-made staggered jumper; insulated; 1-3-5-7-9; Nominal current 25 A; with contact lugs broken off at the factory and circuit marking	<a href="http://www.wago.com/2002-479/011-000">www.wago.com/2002-479/011-000</a>
	<b>Item no.: 2002-480</b> Staggered jumper; insulated; 10-way; Nominal current 25 A; suitable for 2002 and 2003 Series rail-mounted terminal blocks	<a href="http://www.wago.com/2002-480">www.wago.com/2002-480</a>
	<b>Item no.: 2002-481</b> Staggered jumper; insulated; 11-way; Nominal current 25 A; suitable for 2002 and 2003 Series rail-mounted terminal blocks	<a href="http://www.wago.com/2002-481">www.wago.com/2002-481</a>
	<b>Item no.: 2002-481/011-000</b> Ready-made staggered jumper; insulated; 1-3-5-7-9-11; Nominal current 25 A; with contact lugs broken off at the factory and circuit marking	<a href="http://www.wago.com/2002-481/011-000">www.wago.com/2002-481/011-000</a>
	<b>Item no.: 2002-482</b> Staggered jumper; insulated; 12-way; Nominal current 25 A; suitable for 2002 and 2003 Series rail-mounted terminal blocks	<a href="http://www.wago.com/2002-482">www.wago.com/2002-482</a>
	<b>Item no.: 2009-412</b> Push-in type wire jumper; insulated; wire length 60 mm; Conductor cross section 1.5 mm <sup>2</sup> ; suitable for 2001, 2002, 2003 and 2022 Series rail-mounted terminal blocks	<a href="http://www.wago.com/2009-412">www.wago.com/2009-412</a>
	<b>Item no.: 2009-414</b> Push-in type wire jumper; insulated; wire length 110 mm; Conductor cross section 1.5 mm <sup>2</sup> ; suitable for 2001, 2002, 2003 and 2022 Series rail-mounted terminal blocks	<a href="http://www.wago.com/2009-414">www.wago.com/2009-414</a>
	<b>Item no.: 2009-416</b> Push-in type wire jumper; insulated; wire length 250 mm; Conductor cross section 1.5 mm <sup>2</sup> ; suitable for 2001, 2002, 2003 and 2022 Series rail-mounted terminal blocks	<a href="http://www.wago.com/2009-416">www.wago.com/2009-416</a>
	<b>Item no.: 210-103</b> Wire commoning chain; insulated; 50 connections	<a href="http://www.wago.com/210-103">www.wago.com/210-103</a>















Item no.: 210-123





Wire commoning chain; insulated; 50 connections















[www.wago.com/210-123](http://www.wago.com/210-123)

















## General accessories

	<b>Item no.: 2022-161</b> Start module for 1-conductor female connector; with integrated end plate; 2.5 mm <sup>2</sup> ; 1-pole	<a href="http://www.wago.com/2022-161">www.wago.com/2022-161</a>
	<b>Item no.: 2022-162</b> Start module for 1-conductor female connector; with integrated end plate; 2.5 mm <sup>2</sup> ; 1-pole	<a href="http://www.wago.com/2022-162">www.wago.com/2022-162</a>
	<b>Item no.: 2022-164</b> Start module for 1-conductor female connector; with integrated end plate; 2.5 mm <sup>2</sup> ; 1-pole	<a href="http://www.wago.com/2022-164">www.wago.com/2022-164</a>
	<b>Item no.: 2022-167</b> Start module for 1-conductor female connector; with integrated end plate; 2.5 mm <sup>2</sup> ; 1-pole	<a href="http://www.wago.com/2022-167">www.wago.com/2022-167</a>
	<b>Item no.: 2022-171</b> Center module for 1-conductor female connector; 2.5 mm <sup>2</sup> ; 1-pole	<a href="http://www.wago.com/2022-171">www.wago.com/2022-171</a>
	<b>Item no.: 2022-172</b> Center module for 1-conductor female connector; 2.5 mm <sup>2</sup> ; 1-pole	<a href="http://www.wago.com/2022-172">www.wago.com/2022-172</a>
	<b>Item no.: 2022-174</b> Center module for 1-conductor female connector; 2.5 mm <sup>2</sup> ; 1-pole	<a href="http://www.wago.com/2022-174">www.wago.com/2022-174</a>
	<b>Item no.: 2022-177</b> Center module for 1-conductor female connector; 2.5 mm <sup>2</sup> ; 1-pole	<a href="http://www.wago.com/2022-177">www.wago.com/2022-177</a>
	<b>Item no.: 2022-181</b> End module for 1-conductor female connector; 2.5 mm <sup>2</sup> ; 1-pole	<a href="http://www.wago.com/2022-181">www.wago.com/2022-181</a>
	<b>Item no.: 2022-182</b> End module for 1-conductor female connector; 2.5 mm <sup>2</sup> ; 1-pole	<a href="http://www.wago.com/2022-182">www.wago.com/2022-182</a>
	<b>Item no.: 2022-184</b> End module for 1-conductor female connector; 2.5 mm <sup>2</sup> ; 1-pole	<a href="http://www.wago.com/2022-184">www.wago.com/2022-184</a>
	<b>Item no.: 2022-187</b> End module for 1-conductor female connector; 2.5 mm <sup>2</sup> ; 1-pole	<a href="http://www.wago.com/2022-187">www.wago.com/2022-187</a>

## Marking accessories

	<b>Item no.: 2002-161</b> Adaptor	<a href="http://www.wago.com/2002-161">www.wago.com/2002-161</a>
	<b>Item no.: 2009-110</b> Marking strips; on reel; not stretchable; plain; snap-on type	<a href="http://www.wago.com/2009-110">www.wago.com/2009-110</a>
	<b>Item no.: 2009-115</b> WMB-Inline; for smartPRINTER; on reel; stretchable 5 - 5.2 mm; plain; snap-on type	<a href="http://www.wago.com/2009-115">www.wago.com/2009-115</a>
	<b>Item no.: 2009-115/000-002</b> WMB-Inline; for smartPRINTER; on reel; stretchable 5 - 5.2 mm; plain; snap-on type	<a href="http://www.wago.com/2009-115/000-002">www.wago.com/2009-115/000-002</a>
	<b>Item no.: 2009-115/000-006</b> WMB-Inline; for smartPRINTER; on reel; stretchable 5 - 5.2 mm; plain; snap-on type	<a href="http://www.wago.com/2009-115/000-006">www.wago.com/2009-115/000-006</a>

	<b>Item no.: 2009-115/000-007</b> WMB-Inline; for smartPRINTER; on reel; stretchable 5 - 5.2 mm; plain; snap-on type	<a href="http://www.wago.com/2009-115/000-007">www.wago.com/2009-115/000-007</a>
	<b>Item no.: 2009-115/000-012</b> WMB-Inline; for smartPRINTER; on reel; stretchable 5 - 5.2 mm; plain; snap-on type	<a href="http://www.wago.com/2009-115/000-012">www.wago.com/2009-115/000-012</a>
	<b>Item no.: 2009-115/000-017</b> WMB-Inline; for smartPRINTER; on reel; stretchable 5 - 5.2 mm; plain; snap-on type	<a href="http://www.wago.com/2009-115/000-017">www.wago.com/2009-115/000-017</a>
	<b>Item no.: 2009-115/000-023</b> WMB-Inline; for smartPRINTER; on reel; stretchable 5 - 5.2 mm; plain; snap-on type	<a href="http://www.wago.com/2009-115/000-023">www.wago.com/2009-115/000-023</a>
	<b>Item no.: 2009-115/000-024</b> WMB-Inline; for smartPRINTER; on reel; stretchable 5 - 5.2 mm; plain; snap-on type	<a href="http://www.wago.com/2009-115/000-024">www.wago.com/2009-115/000-024</a>
	<b>Item no.: 2009-145</b> Mini-WSB Inline; for smartPRINTER; on reel; stretchable 5 - 5.2 mm; plain; snap-on type	<a href="http://www.wago.com/2009-145">www.wago.com/2009-145</a>
	<b>Item no.: 2009-145/000-002</b> Mini-WSB Inline; for smartPRINTER; on reel; stretchable 5 - 5.2 mm; plain; snap-on type	<a href="http://www.wago.com/2009-145/000-002">www.wago.com/2009-145/000-002</a>
	<b>Item no.: 2009-145/000-005</b> Mini-WSB Inline; for smartPRINTER; on reel; stretchable 5 - 5.2 mm; plain; snap-on type	<a href="http://www.wago.com/2009-145/000-005">www.wago.com/2009-145/000-005</a>
	<b>Item no.: 2009-145/000-006</b> Mini-WSB Inline; for smartPRINTER; on reel; stretchable 5 - 5.2 mm; plain; snap-on type	<a href="http://www.wago.com/2009-145/000-006">www.wago.com/2009-145/000-006</a>
	<b>Item no.: 2009-145/000-007</b> Mini-WSB Inline; for smartPRINTER; on reel; stretchable 5 - 5.2 mm; plain; snap-on type	<a href="http://www.wago.com/2009-145/000-007">www.wago.com/2009-145/000-007</a>
	<b>Item no.: 2009-145/000-012</b> Mini-WSB Inline; for smartPRINTER; on reel; stretchable 5 - 5.2 mm; plain; snap-on type	<a href="http://www.wago.com/2009-145/000-012">www.wago.com/2009-145/000-012</a>
	<b>Item no.: 2009-145/000-023</b> Mini-WSB Inline; for smartPRINTER; on reel; stretchable 5 - 5.2 mm; plain; snap-on type	<a href="http://www.wago.com/2009-145/000-023">www.wago.com/2009-145/000-023</a>
	<b>Item no.: 2009-145/000-024</b> Mini-WSB Inline; on reel; stretchable 5 - 5.2 mm; plain; snap-on type	<a href="http://www.wago.com/2009-145/000-024">www.wago.com/2009-145/000-024</a>
	<b>Item no.: 2009-191</b> Group marker carrier	<a href="http://www.wago.com/2009-191">www.wago.com/2009-191</a>
	<b>Item no.: 2009-192</b> Group marker carrier	<a href="http://www.wago.com/2009-192">www.wago.com/2009-192</a>
	<b>Item no.: 2009-193</b>	

	Group marker carrier	<a href="http://www.wago.com/2009-193">www.wago.com/2009-193</a>
	<b>Item no.: 2009-198</b> Adaptor	<a href="http://www.wago.com/2009-198">www.wago.com/2009-198</a>
	<b>Item no.: 248-501</b> Miniature WSB Quick marking system; plain; Marker width 5 mm; 10 strips with 10 markers per card	<a href="http://www.wago.com/248-501">www.wago.com/248-501</a>
	<b>Item no.: 248-501/000-002</b> Mini-WSB marking card; as card; not stretchable; plain; snap-on type	<a href="http://www.wago.com/248-501/000-002">www.wago.com/248-501/000-002</a>
	<b>Item no.: 248-501/000-005</b> Mini-WSB marking card; as card; plain; snap-on type	<a href="http://www.wago.com/248-501/000-005">www.wago.com/248-501/000-005</a>
	<b>Item no.: 248-501/000-006</b> Mini-WSB marking card; as card; not stretchable; plain; snap-on type	<a href="http://www.wago.com/248-501/000-006">www.wago.com/248-501/000-006</a>
	<b>Item no.: 248-501/000-007</b> Mini-WSB marking card; as card; not stretchable; plain; snap-on type	<a href="http://www.wago.com/248-501/000-007">www.wago.com/248-501/000-007</a>
	<b>Item no.: 248-501/000-012</b> Mini-WSB marking card; as card; not stretchable; plain; snap-on type	<a href="http://www.wago.com/248-501/000-012">www.wago.com/248-501/000-012</a>
	<b>Item no.: 248-501/000-017</b> Mini-WSB marking card; as card; not stretchable; plain; snap-on type	<a href="http://www.wago.com/248-501/000-017">www.wago.com/248-501/000-017</a>
	<b>Item no.: 248-501/000-023</b> Mini-WSB marking card; as card; not stretchable; plain; snap-on type	<a href="http://www.wago.com/248-501/000-023">www.wago.com/248-501/000-023</a>
	<b>Item no.: 793-501</b> WMB marking card; as card; not stretchable; plain; snap-on type	<a href="http://www.wago.com/793-501">www.wago.com/793-501</a>
	<b>Item no.: 793-501/000-002</b> WMB marking card; as card; not stretchable; plain; snap-on type	<a href="http://www.wago.com/793-501/000-002">www.wago.com/793-501/000-002</a>
	<b>Item no.: 793-501/000-005</b> WMB marking card; as card; not stretchable; plain; snap-on type	<a href="http://www.wago.com/793-501/000-005">www.wago.com/793-501/000-005</a>
	<b>Item no.: 793-501/000-006</b> WMB marking card; as card; not stretchable; plain; snap-on type	<a href="http://www.wago.com/793-501/000-006">www.wago.com/793-501/000-006</a>
	<b>Item no.: 793-501/000-007</b> WMB marking card; as card; not stretchable; plain; snap-on type	<a href="http://www.wago.com/793-501/000-007">www.wago.com/793-501/000-007</a>
	<b>Item no.: 793-501/000-012</b> WMB marking card; as card; not stretchable; plain; snap-on type	<a href="http://www.wago.com/793-501/000-012">www.wago.com/793-501/000-012</a>



**Item no.: 793-501/000-017**  
WMB marking card; as card; not stretchable; plain; snap-on type

[www.wago.com/793-501/000-017](http://www.wago.com/793-501/000-017)



**Item no.: 793-501/000-023**  
WMB marking card; as card; not stretchable; plain; snap-on type

[www.wago.com/793-501/000-023](http://www.wago.com/793-501/000-023)



**Item no.: 793-501/000-024**  
WMB marking card; as card; not stretchable; plain; snap-on type

[www.wago.com/793-501/000-024](http://www.wago.com/793-501/000-024)



**Item no.: 793-5501**  
WMB marking card; as card; for terminal block width 5 - 17.5 mm; stretchable 5 - 5.2 mm; plain; snap-on type

[www.wago.com/793-5501](http://www.wago.com/793-5501)



**Item no.: 793-5501/000-002**  
WMB marking card; as card; for terminal block width 5 - 17.5 mm; stretchable 5 - 5.2 mm; plain; snap-on type

[www.wago.com/793-5501/000-002](http://www.wago.com/793-5501/000-002)



**Item no.: 793-5501/000-005**  
WMB marking card; as card; stretchable 5 - 5.2 mm; plain; snap-on type

[www.wago.com/793-5501/000-005](http://www.wago.com/793-5501/000-005)



**Item no.: 793-5501/000-006**  
WMB marking card; as card; stretchable 5 - 5.2 mm; plain; snap-on type

[www.wago.com/793-5501/000-006](http://www.wago.com/793-5501/000-006)



**Item no.: 793-5501/000-007**  
WMB marking card; as card; stretchable 5 - 5.2 mm; plain; snap-on type

[www.wago.com/793-5501/000-007](http://www.wago.com/793-5501/000-007)



**Item no.: 793-5501/000-012**  
WMB marking card; as card; stretchable 5 - 5.2 mm; plain; snap-on type

[www.wago.com/793-5501/000-012](http://www.wago.com/793-5501/000-012)



**Item no.: 793-5501/000-017**  
WMB marking card; as card; stretchable 5 - 5.2 mm; plain; snap-on type

[www.wago.com/793-5501/000-017](http://www.wago.com/793-5501/000-017)



**Item no.: 793-5501/000-023**  
WMB marking card; as card; stretchable 5 - 5.2 mm; plain; snap-on type

[www.wago.com/793-5501/000-023](http://www.wago.com/793-5501/000-023)



**Item no.: 793-5501/000-024**  
WMB marking card; as card; stretchable 5 - 5.2 mm; plain; snap-on type

[www.wago.com/793-5501/000-024](http://www.wago.com/793-5501/000-024)

#### Carrier rail



**Item no.: 210-112**  
Steel carrier rail; 35 x 7.5 mm; 1 mm thick; 2 m long; slotted; according to EN 60715; "Hole width 25 mm

[www.wago.com/210-112](http://www.wago.com/210-112)



**Item no.: 210-113**  
Steel carrier rail; 35 x 7.5 mm; 1 mm thick; 2 m long; unslotted; according to EN 60715

[www.wago.com/210-113](http://www.wago.com/210-113)

**Item no.: 210-114**  
Steel carrier rail; 35 x 15 mm; 1.5 mm thick; 2 m long; unslotted; similar to EN 60715

[www.wago.com/210-114](http://www.wago.com/210-114)

**Item no.: 210-115**

Steel carrier rail; 35 x 7.5 mm; 1 mm thick; 2 m long; slotted; according to EN 60715; "Hole width 18 mm

[www.wago.com/210-115](http://www.wago.com/210-115)**Item no.: 210-118**

Steel carrier rail; 35 x 15 mm; 2.3 mm thick; 2 m long; unslotted; according to EN 60715

[www.wago.com/210-118](http://www.wago.com/210-118)**Item no.: 210-196**

Aluminum carrier rail; 35 x 8.2 mm; 1.6 mm thick; 2 m long; unslotted; similar to EN 60715

[www.wago.com/210-196](http://www.wago.com/210-196)**Item no.: 210-197**

Steel carrier rail; 35 x 15 mm; 1.5 mm thick; 2 m long; slotted; similar to EN 60715

[www.wago.com/210-197](http://www.wago.com/210-197)**Item no.: 210-198**

Copper carrier rail; 35 x 15 mm; 2.3 mm thick; 2 m long; unslotted; according to EN 60715

[www.wago.com/210-198](http://www.wago.com/210-198)**Coding****Item no.: 2022-100**

Carrier with 6 coding pins; for coding of female plugs

[www.wago.com/2022-100](http://www.wago.com/2022-100)**check****Item no.: 2002-511**

Modular TOPJOB®S connector; modular; for jumper contact slot; 1-pole

[www.wago.com/2002-511](http://www.wago.com/2002-511)**Item no.: 2002-549**

Spacer module; modular; e.g., for bridging commoned terminal blocks

[www.wago.com/2002-549](http://www.wago.com/2002-549)**Item no.: 2002-552**

TOPJOB®S connector strip; for jumper contact slot; 2-pole

[www.wago.com/2002-552](http://www.wago.com/2002-552)**Item no.: 2002-553**

TOPJOB®S connector strip; for jumper contact slot; 3-pole

[www.wago.com/2002-553](http://www.wago.com/2002-553)**Item no.: 2002-554**

TOPJOB®S connector strip; for jumper contact slot; 4-pole

[www.wago.com/2002-554](http://www.wago.com/2002-554)**Item no.: 2002-555**

TOPJOB®S connector strip; for jumper contact slot; 5-pole

[www.wago.com/2002-555](http://www.wago.com/2002-555)**Item no.: 2002-556**

TOPJOB®S connector strip; for jumper contact slot; 6-pole

[www.wago.com/2002-556](http://www.wago.com/2002-556)**Item no.: 2002-557**

TOPJOB®S connector strip; for jumper contact slot; 7-pole

[www.wago.com/2002-557](http://www.wago.com/2002-557)**Item no.: 2002-558**

TOPJOB®S connector strip; for jumper contact slot; 8-pole

[www.wago.com/2002-558](http://www.wago.com/2002-558)**Item no.: 2002-559**

TOPJOB®S connector strip; for jumper contact slot; 9-pole

[www.wago.com/2002-559](http://www.wago.com/2002-559)**Item no.: 2002-560**

TOPJOB®S connector strip; for jumper contact slot; 10-pole

[www.wago.com/2002-560](http://www.wago.com/2002-560)



Item no.: 2009-174

Test plug adapter; for 4 mm Ø test plugs; for testing TOPJOB®S rail-mounted terminal blocks

[www.wago.com/2009-174](http://www.wago.com/2009-174)



Item no.: 2009-182

Testing tap; for max. 2.5 mm<sup>2</sup>; tool-free connection for individual test wires 0.08 - 2.5 mm

[www.wago.com/2009-182](http://www.wago.com/2009-182)



Item no.: 859-500

Test pin; 1 mm Ø; with solder connection for test wire

[www.wago.com/859-500](http://www.wago.com/859-500)

## Downloads

### Documentation

#### Bid Text

2022-1201	Aug 15, 2018	DOCX 15.5 kB	Download
-----------	--------------	-----------------	----------

## smartDATA

### CAD data

3D Download 2022-1201	URL	Download
-----------------------	-----	----------

## Product family

### X-COM S

[Show all products from the family](#)

Subject to changes.