

Data sheet | Item number: 2022-1304

2-conductor/1-pin carrier terminal block; for DIN-rail 35 x 15 and 35 x 7.5;
2.5 mm²; Push-in CAGE CLAMP®

www.wago.com/2022-1304

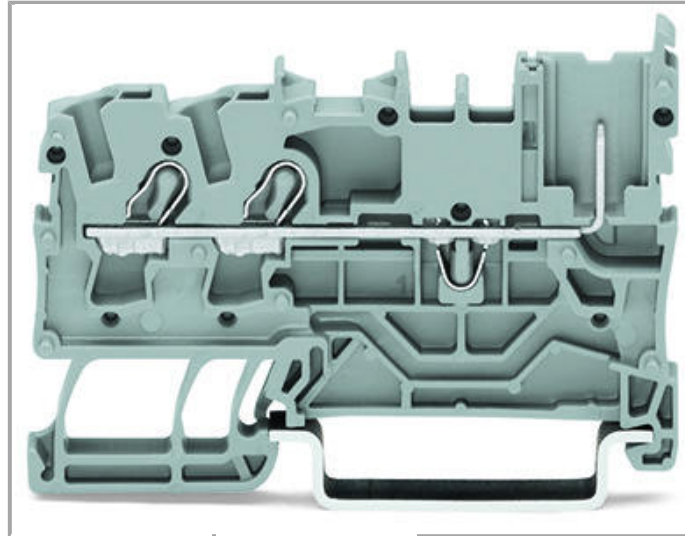

RoHS
Compliant

BOMcheck.net

Color: ■

Data

Electrical data

Ratings per IEC/EN 60664-1

Rated voltage (III / 3)	690 V
Rated impulse voltage (III / 3)	6 kV
Rated current	20 A
Legend (ratings)	(III / 3) ≙ Overvoltage category III / Pollution degree 3

Connection data

Connection technology	Push-in CAGE CLAMP®
Number of connection points (connection type)	2
Actuation type	Operating tool Push-in
Connectable conductor materials	Copper Aluminum
Nominal cross section	2.5 mm ²
Solid conductor	0.25 ... 4 mm ² / 22 ... 12 AWG

Solid conductor, push-in termination	0.75 ... 4 mm ² / 18 ... 12 AWG
Fine-stranded conductor	0.25 ... 4 mm ² / 22 ... 12 AWG
Fine-stranded conductor with ferrule, push-in termination, from	0.75 mm ² / 18 AWG
Strip length	10 ... 12 mm / 0.39 ... 0.47 Inch
Number of connection points	1
Total number of connection points	2
Total number of potentials	1
Number of levels	1
Type of wiring	Front-entry wiring

Geometrical Data

Width	5.2 mm / 0.205 inch
Height from upper-edge of DIN-35 rail	32.5 mm / 1.28 inch
Depth	59.2 mm / 2.331 inch

Mechanical data

Design	horizontal
Type of mounting	DIN-35 rail
Marking level	Center/side marking

Material Data

Color	blue
Insulating material	Polyamide 66 (PA 66)
Fire load	0.136 MJ
Weight	6.303 g

Commercial data



Country of origin	CN
GTIN	4050821145134
Customs Tariff No.	85369010000
Product Group	18 (X-COM-System)

Approvals / Certificates

Country specific Approvals

Logo	Approval	Certificate name
	CSA DEKRA Certification B.V.	70107915

Ship Approvals

Logo	Approval	Certificate name
	ABS American Bureau of Shipping	14-HG1293677-PDA
	BV Bureau Veritas S.A.	38586/A0 BV
	LR Lloyds Register	91/20112 (E9)

UL-Approvals

Logo	Approval	Certificate name
	UR Underwriters Laboratories Inc.	E45172

Compatible products





tools

















	Item no.: 210-720 Operating tool with partially insulated shaft; Type 2, blade (3.5 x 0.5) mm	www.wago.com/210-720
--	---	--

















End plate













	Item no.: 2022-1391 End and intermediate plate; 1 mm thick	www.wago.com/2022-1391
	Item no.: 2022-1392 End and intermediate plate; 1 mm thick	www.wago.com/2022-1392













Jumper



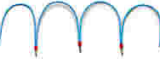

	Item no.: 2002-400 Adjacent jumper for continuous commoning; insulated; 2-way; Nominal current 25 A	www.wago.com/2002-400
	Item no.: 2002-402 Push-in type jumper bar; insulated; 2-way; Nominal current 25 A	www.wago.com/2002-402
	Item no.: 2002-402/000-005 Push-in type jumper bar; insulated; 2-way; Nominal current 25 A	www.wago.com/2002-402/000-005
	Item no.: 2002-402/000-006 Push-in type jumper bar; insulated; 2-way; Nominal current 25 A	www.wago.com/2002-402/000-006











	Item no.: 2002-403 Push-in type jumper bar; insulated; 3-way; Nominal current 25 A	www.wago.com/2002-403
	Item no.: 2002-403/000-005 Push-in type jumper bar; insulated; 3-way; Nominal current 25 A	www.wago.com/2002-403/000-005
	Item no.: 2002-403/000-006 Push-in type jumper bar; insulated; 3-way; Nominal current 25 A	www.wago.com/2002-403/000-006
	Item no.: 2002-404 Push-in type jumper bar; insulated; 4-way; Nominal current 25 A	www.wago.com/2002-404
	Item no.: 2002-404/000-005 Push-in type jumper bar; insulated; 4-way; Nominal current 25 A	www.wago.com/2002-404/000-005
	Item no.: 2002-404/000-006 Push-in type jumper bar; insulated; 4-way; Nominal current 25 A	www.wago.com/2002-404/000-006
	Item no.: 2002-405 Push-in type jumper bar; insulated; 5-way; Nominal current 25 A	www.wago.com/2002-405
	Item no.: 2002-405/000-005 Push-in type jumper bar; insulated; 5-way; Nominal current 25 A	www.wago.com/2002-405/000-005
	Item no.: 2002-405/000-006 Push-in type jumper bar; insulated; 5-way; Nominal current 25 A	www.wago.com/2002-405/000-006
	Item no.: 2002-405/011-000 Star point jumper; insulated; 3-way (1-3-5); IN = IN terminal block	www.wago.com/2002-405/011-000
	Item no.: 2002-406 Push-in type jumper bar; insulated; 6-way; Nominal current 25 A	www.wago.com/2002-406
	Item no.: 2002-406/000-005 Push-in type jumper bar; insulated; 6-way; Nominal current 25 A	www.wago.com/2002-406/000-005
	Item no.: 2002-406/000-006 Push-in type jumper bar; insulated; 6-way; Nominal current 25 A	www.wago.com/2002-406/000-006
	Item no.: 2002-406/020-000 Delta jumper; insulated; 1-2 3-4 5-6; IN = IN terminal block	www.wago.com/2002-406/020-000
	Item no.: 2002-407 Push-in type jumper bar; insulated; 7-way; Nominal current 25 A	www.wago.com/2002-407
	Item no.: 2002-407/000-005 Push-in type jumper bar; insulated; 7-way; Nominal current 25 A	www.wago.com/2002-407/000-005











	Item no.: 2002-407/000-006 Push-in type jumper bar; insulated; 7-way; Nominal current 25 A	www.wago.com/2002-407/000-006
	Item no.: 2002-408 Push-in type jumper bar; insulated; 8-way; Nominal current 25 A	www.wago.com/2002-408
	Item no.: 2002-408/000-005 Push-in type jumper bar; insulated; 8-way; Nominal current 25 A	www.wago.com/2002-408/000-005
	Item no.: 2002-408/000-006 Push-in type jumper bar; insulated; 8-way; Nominal current 25 A	www.wago.com/2002-408/000-006
	Item no.: 2002-409 Push-in type jumper bar; insulated; 9-way; Nominal current 25 A	www.wago.com/2002-409
	Item no.: 2002-409/000-005 Push-in type jumper bar; insulated; 9-way; Nominal current 25 A	www.wago.com/2002-409/000-005
	Item no.: 2002-409/000-006 Push-in type jumper bar; insulated; 9-way; Nominal current 25 A	www.wago.com/2002-409/000-006
	Item no.: 2002-410 Push-in type jumper bar; insulated; 10-way; Nominal current 25 A	www.wago.com/2002-410
	Item no.: 2002-410/000-005 Push-in type jumper bar; insulated; 10-way; Nominal current 25 A	www.wago.com/2002-410/000-005
	Item no.: 2002-410/000-006 Push-in type jumper bar; insulated; 10-way; Nominal current 25 A	www.wago.com/2002-410/000-006
	Item no.: 2002-423 Push-in type jumper bar; insulated; from 1 to 3; Nominal current 25 A	www.wago.com/2002-423
	Item no.: 2002-423/000-005 Adjacent jumper for continuous commoning; insulated; from 1 to 3; Nominal current 25 A	www.wago.com/2002-423/000-005
	Item no.: 2002-423/000-006 Adjacent jumper for continuous commoning; insulated; from 1 to 3; Nominal current 25 A	www.wago.com/2002-423/000-006
	Item no.: 2002-433 Push-in type jumper bar; insulated; from 1 to 3; Nominal current 25 A	www.wago.com/2002-433
	Item no.: 2002-434 Push-in type jumper bar; insulated; from 1 to 4; Nominal current 25 A	www.wago.com/2002-434
	Item no.: 2002-435 Push-in type jumper bar; insulated; from 1 to 5; Nominal current 25 A	www.wago.com/2002-435
	Item no.: 2002-436 Push-in type jumper bar; insulated; from 1 to 6; Nominal current 25 A	www.wago.com/2002-436

	Item no.: 2002-437 Push-in type jumper bar; insulated; from 1 to 7; Nominal current 25 A	www.wago.com/2002-437
	Item no.: 2002-438 Push-in type jumper bar; insulated; from 1 to 8; Nominal current 25 A	www.wago.com/2002-438
	Item no.: 2002-439 Push-in type jumper bar; insulated; from 1 to 9; Nominal current 25 A	www.wago.com/2002-439
	Item no.: 2002-440 Push-in type jumper bar; insulated; from 1 to 10; Nominal current 25 A	www.wago.com/2002-440
	Item no.: 2002-472 Staggered jumper; insulated; 2-way; Nominal current 25 A; suitable for 2002 and 2003 Series rail-mounted terminal blocks	www.wago.com/2002-472
	Item no.: 2002-473 Staggered jumper; insulated; 3-way; Nominal current 25 A; suitable for 2002 and 2003 Series rail-mounted terminal blocks	www.wago.com/2002-473
	Item no.: 2002-473/011-000 Ready-made staggered jumper; insulated; 2-way (1-3); Nominal current 25 A; with contact lugs broken off at the factory and circuit marking	www.wago.com/2002-473/011-000
	Item no.: 2002-474 Staggered jumper; insulated; 4-way; Nominal current 25 A; suitable for 2002 and 2003 Series rail-mounted terminal blocks	www.wago.com/2002-474
	Item no.: 2002-475 Staggered jumper; insulated; 5-way; Nominal current 25 A; suitable for 2002 and 2003 Series rail-mounted terminal blocks	www.wago.com/2002-475
	Item no.: 2002-475/011-000 Ready-made staggered jumper; insulated; 3-way (1-3-5); Nominal current 25 A; with contact lugs broken off at the factory and circuit marking	www.wago.com/2002-475/011-000
	Item no.: 2002-476 Staggered jumper; insulated; 6-way; Nominal current 25 A; suitable for 2002 and 2003 Series rail-mounted terminal blocks	www.wago.com/2002-476
	Item no.: 2002-477 Staggered jumper; insulated; 7-way; Nominal current 25 A; suitable for 2002 and 2003 Series rail-mounted terminal blocks	www.wago.com/2002-477
	Item no.: 2002-477/011-000 Ready-made staggered jumper; insulated; 1-3-5-7; Nominal current 25 A; with contact lugs broken off at the factory and circuit marking	www.wago.com/2002-477/011-000
	Item no.: 2002-478 Staggered jumper; insulated; 8-way; Nominal current 25 A; suitable for 2002 and 2003 Series rail-mounted terminal blocks	www.wago.com/2002-478
	Item no.: 2002-479 Staggered jumper; insulated; 9-way; Nominal current 25 A; suitable for 2002 and 2003 Series rail-mounted terminal blocks	www.wago.com/2002-479
	Item no.: 2002-479/011-000 Ready-made staggered jumper; insulated; 1-3-5-7-9; Nominal current 25 A; with contact lugs broken off at the factory and circuit marking	www.wago.com/2002-479/011-000
	Item no.: 2002-480 Staggered jumper; insulated; 10-way; Nominal current 25 A; suitable for 2002 and 2003 Series rail-mounted terminal blocks	www.wago.com/2002-480

	Item no.: 2002-481 Staggered jumper; insulated; 11-way; Nominal current 25 A; suitable for 2002 and 2003 Series rail-mounted terminal blocks	www.wago.com/2002-481
	Item no.: 2002-481/011-000 Ready-made staggered jumper; insulated; 1-3-5-7-9-11; Nominal current 25 A; with contact lugs broken off at the factory and circuit marking	www.wago.com/2002-481/011-000
	Item no.: 2002-482 Staggered jumper; insulated; 12-way; Nominal current 25 A; suitable for 2002 and 2003 Series rail-mounted terminal blocks	www.wago.com/2002-482
	Item no.: 2009-412 Push-in type wire jumper; insulated; wire length 60 mm; Conductor cross section 1.5 mm ² ; suitable for 2001, 2002, 2003 and 2022 Series rail-mounted terminal blocks	www.wago.com/2009-412
	Item no.: 2009-414 Push-in type wire jumper; insulated; wire length 110 mm; Conductor cross section 1.5 mm ² ; suitable for 2001, 2002, 2003 and 2022 Series rail-mounted terminal blocks	www.wago.com/2009-414
	Item no.: 2009-416 Push-in type wire jumper; insulated; wire length 250 mm; Conductor cross section 1.5 mm ² ; suitable for 2001, 2002, 2003 and 2022 Series rail-mounted terminal blocks	www.wago.com/2009-416
	Item no.: 210-103 Wire commoning chain; insulated; 50 connections	www.wago.com/210-103
	Item no.: 210-123 Wire commoning chain; insulated; 50 connections	www.wago.com/210-123
Protective Warning Marker		
	Item no.: 2002-115 Protective warning marker; with high-voltage symbol, black; for 5 terminal blocks	www.wago.com/2002-115
Female plug		
	Item no.: 2022-101 1-conductor female plug; 2.5 mm ² ; 1-pole	www.wago.com/2022-101
	Item no.: 2022-101/000-006 1-conductor female plug; 1-pole	www.wago.com/2022-101/000-006
	Item no.: 2022-101/000-012 1-conductor female plug; 1-pole	www.wago.com/2022-101/000-012
	Item no.: 2022-101/000-016 1-conductor female plug; 1-pole	www.wago.com/2022-101/000-016
	Item no.: 2022-101/122-000 1-conductor female plug; 1-pole	www.wago.com/2022-101/122-000
	Item no.: 2022-101/122-006 1-conductor female plug; 1-pole	www.wago.com/2022-101/122-006

	Item no.: 2022-101/122-016 1-conductor female plug; 1-pole	www.wago.com/2022-101/122-016
	Item no.: 2022-101/132-000 1-conductor female plug; Strain relief plate; 1-pole	www.wago.com/2022-101/132-000
	Item no.: 2022-101/132-006 1-conductor female plug; Strain relief plate; 1-pole	www.wago.com/2022-101/132-006
	Item no.: 2022-101/132-016 1-conductor female plug; Strain relief plate; 1-pole	www.wago.com/2022-101/132-016
	Item no.: 2022-101/142-000 1-conductor female plug; Strain relief plate; 1-pole	www.wago.com/2022-101/142-000
	Item no.: 2022-101/142-006 1-conductor female plug; Strain relief plate; 1-pole	www.wago.com/2022-101/142-006
	Item no.: 2022-101/142-016 1-conductor female plug; Strain relief plate; 1-pole	www.wago.com/2022-101/142-016
	Item no.: 2022-102 1-conductor female plug; 2.5 mm ² ; 2-pole	www.wago.com/2022-102
	Item no.: 2022-102/000-006 1-conductor female plug; 2.5 mm ² ; 2-pole	www.wago.com/2022-102/000-006
	Item no.: 2022-102/000-016 1-conductor female plug; 2.5 mm ² ; 2-pole	www.wago.com/2022-102/000-016
	Item no.: 2022-102/122-000 1-conductor female plug; Locking lever; 2.5 mm ² ; 2-pole	www.wago.com/2022-102/122-000
	Item no.: 2022-102/132-000 1-conductor female plug; Strain relief plate; 2.5 mm ² ; 2-pole	www.wago.com/2022-102/132-000
	Item no.: 2022-102/142-000 1-conductor female plug; Strain relief plate; 2.5 mm ² ; 2-pole	www.wago.com/2022-102/142-000
	Item no.: 2022-103 1-conductor female plug; 2.5 mm ² ; 3-pole	www.wago.com/2022-103
	Item no.: 2022-103/000-006 1-conductor female plug; 2.5 mm ² ; 3-pole	www.wago.com/2022-103/000-006

	Item no.: 2022-103/000-016 1-conductor female plug; 2.5 mm ² ; 3-pole	www.wago.com/2022-103/000-016
	Item no.: 2022-103/000-036 1-conductor female plug; 2.5 mm ² ; 3-pole	www.wago.com/2022-103/000-036
	Item no.: 2022-103/000-037 1-conductor female plug; 2.5 mm ² ; 3-pole	www.wago.com/2022-103/000-037
	Item no.: 2022-103/000-038 1-conductor female plug; 2.5 mm ² ; 3-pole	www.wago.com/2022-103/000-038
	Item no.: 2022-103/000-039 1-conductor female plug; 2.5 mm ² ; 3-pole	www.wago.com/2022-103/000-039
	Item no.: 2022-103/123-000 1-conductor female plug; Locking lever; 2.5 mm ² ; 3-pole	www.wago.com/2022-103/123-000
	Item no.: 2022-103/133-000 1-conductor female plug; Strain relief plate; 2.5 mm ² ; 3-pole	www.wago.com/2022-103/133-000
	Item no.: 2022-103/143-000 1-conductor female plug; Strain relief plate; 2.5 mm ² ; 3-pole	www.wago.com/2022-103/143-000
	Item no.: 2022-104 1-conductor female plug; 2.5 mm ² ; 4-pole	www.wago.com/2022-104
	Item no.: 2022-104/000-006 1-conductor female plug; 2.5 mm ² ; 4-pole	www.wago.com/2022-104/000-006
	Item no.: 2022-104/000-016 1-conductor female plug; 2.5 mm ² ; 4-pole	www.wago.com/2022-104/000-016
	Item no.: 2022-104/000-036 1-conductor female plug; 2.5 mm ² ; 4-pole	www.wago.com/2022-104/000-036
	Item no.: 2022-104/000-037 1-conductor female plug; 2.5 mm ² ; 4-pole	www.wago.com/2022-104/000-037
	Item no.: 2022-104/000-038 1-conductor female plug; 2.5 mm ² ; 4-pole	www.wago.com/2022-104/000-038
	Item no.: 2022-104/000-039 1-conductor female plug; 2.5 mm ² ; 4-pole	www.wago.com/2022-104/000-039

	Item no.: 2022-104/123-000 1-conductor female plug; Locking lever; 2.5 mm ² ; 4-pole	www.wago.com/2022-104/123-000
	Item no.: 2022-104/133-000 1-conductor female plug; Strain relief plate; 2.5 mm ² ; 4-pole	www.wago.com/2022-104/133-000
	Item no.: 2022-104/143-000 1-conductor female plug; Strain relief plate; 2.5 mm ² ; 4-pole	www.wago.com/2022-104/143-000
	Item no.: 2022-105 1-conductor female plug; 2.5 mm ² ; 5-pole	www.wago.com/2022-105
	Item no.: 2022-105/000-006 1-conductor female plug; 2.5 mm ² ; 5-pole	www.wago.com/2022-105/000-006
	Item no.: 2022-105/000-016 1-conductor female plug; 2.5 mm ² ; 5-pole	www.wago.com/2022-105/000-016
	Item no.: 2022-105/000-036 1-conductor female plug; 2.5 mm ² ; 5-pole	www.wago.com/2022-105/000-036
	Item no.: 2022-105/000-037 1-conductor female plug; 2.5 mm ² ; 5-pole	www.wago.com/2022-105/000-037
	Item no.: 2022-105/000-038 1-conductor female plug; 2.5 mm ² ; 5-pole	www.wago.com/2022-105/000-038
	Item no.: 2022-105/000-039 1-conductor female plug; 2.5 mm ² ; 5-pole	www.wago.com/2022-105/000-039
	Item no.: 2022-105/123-000 1-conductor female plug; Locking lever; 2.5 mm ² ; 5-pole	www.wago.com/2022-105/123-000
	Item no.: 2022-105/134-000 1-conductor female plug; Strain relief plate; 2.5 mm ² ; 5-pole	www.wago.com/2022-105/134-000
	Item no.: 2022-105/144-000 1-conductor female plug; Strain relief plate; 2.5 mm ² ; 5-pole	www.wago.com/2022-105/144-000
	Item no.: 2022-106 1-conductor female plug; 2.5 mm ² ; 6-pole	www.wago.com/2022-106
	Item no.: 2022-106/000-006 1-conductor female plug; 2.5 mm ² ; 6-pole	www.wago.com/2022-106/000-006



Item no.: 2022-106/000-016
1-conductor female plug; 2.5 mm²; 6-pole

www.wago.com/2022-106/000-016



Item no.: 2022-106/000-036
1-conductor female plug; 2.5 mm²; 6-pole

www.wago.com/2022-106/000-036



Item no.: 2022-106/000-037
1-conductor female plug; 2.5 mm²; 6-pole

www.wago.com/2022-106/000-037



Item no.: 2022-106/000-038
1-conductor female plug; 2.5 mm²; 6-pole

www.wago.com/2022-106/000-038



Item no.: 2022-106/000-039
1-conductor female plug; 2.5 mm²; 6-pole

www.wago.com/2022-106/000-039

Item no.: 2022-106/123-000
1-conductor female plug; Locking lever; 2.5 mm²; 6-pole

www.wago.com/2022-106/123-000

Item no.: 2022-106/134-000
1-conductor female plug; Strain relief plate; 2.5 mm²; 6-pole

www.wago.com/2022-106/134-000

Item no.: 2022-106/144-000
1-conductor female plug; Strain relief plate; 2.5 mm²; 6-pole

www.wago.com/2022-106/144-000

Item no.: 2022-107
1-conductor female plug; 2.5 mm²; 7-pole

www.wago.com/2022-107



Item no.: 2022-107/000-006
1-conductor female plug; 2.5 mm²; 7-pole

www.wago.com/2022-107/000-006



Item no.: 2022-107/000-016
1-conductor female plug; 2.5 mm²; 7-pole

www.wago.com/2022-107/000-016



Item no.: 2022-107/000-036
1-conductor female plug; 2.5 mm²; 7-pole

www.wago.com/2022-107/000-036



Item no.: 2022-107/000-037
1-conductor female plug; 2.5 mm²; 7-pole

www.wago.com/2022-107/000-037







Item no.: 2022-107/000-038
1-conductor female plug; 2.5 mm²; 7-pole

www.wago.com/2022-107/000-038

Item no.: 2022-107/000-039
1-conductor female plug; 2.5 mm²; 7-pole

www.wago.com/2022-107/000-039

	Item no.: 2022-107/123-000 1-conductor female plug; Locking lever; 2.5 mm ² ; 7-pole	www.wago.com/2022-107/123-000
	Item no.: 2022-107/135-000 1-conductor female plug; Strain relief plate; 2.5 mm ² ; 7-pole	www.wago.com/2022-107/135-000
	Item no.: 2022-107/145-000 1-conductor female plug; Strain relief plate; 2.5 mm ² ; 7-pole	www.wago.com/2022-107/145-000
	Item no.: 2022-108 1-conductor female plug; 2.5 mm ² ; 8-pole	www.wago.com/2022-108
	Item no.: 2022-108/000-006 1-conductor female plug; 2.5 mm ² ; 8-pole	www.wago.com/2022-108/000-006
	Item no.: 2022-108/000-016 1-conductor female plug; 2.5 mm ² ; 8-pole	www.wago.com/2022-108/000-016
	Item no.: 2022-108/000-036 1-conductor female plug; 2.5 mm ² ; 8-pole	www.wago.com/2022-108/000-036
	Item no.: 2022-108/000-037 1-conductor female plug; 2.5 mm ² ; 8-pole	www.wago.com/2022-108/000-037
	Item no.: 2022-108/000-038 1-conductor female plug; 2.5 mm ² ; 8-pole	www.wago.com/2022-108/000-038
	Item no.: 2022-108/000-039 1-conductor female plug; 2.5 mm ² ; 8-pole	www.wago.com/2022-108/000-039
	Item no.: 2022-108/123-000 1-conductor female plug; Locking lever; 2.5 mm ² ; 8-pole	www.wago.com/2022-108/123-000
	Item no.: 2022-108/135-000 1-conductor female plug; Strain relief plate; 2.5 mm ² ; 8-pole	www.wago.com/2022-108/135-000
	Item no.: 2022-108/145-000 1-conductor female plug; Strain relief plate; 2.5 mm ² ; 8-pole	www.wago.com/2022-108/145-000
	Item no.: 2022-109 1-conductor female plug; 2.5 mm ² ; 9-pole	www.wago.com/2022-109
	Item no.: 2022-109/000-006 1-conductor female plug; 2.5 mm ² ; 9-pole	www.wago.com/2022-109/000-006



Item no.: 2022-109/000-016
1-conductor female plug; 2.5 mm²; 9-pole

www.wago.com/2022-109/000-016



Item no.: 2022-109/000-036
1-conductor female plug; 2.5 mm²; 9-pole

www.wago.com/2022-109/000-036



Item no.: 2022-109/000-037
1-conductor female plug; 2.5 mm²; 9-pole

www.wago.com/2022-109/000-037



Item no.: 2022-109/000-038
1-conductor female plug; 2.5 mm²; 9-pole

www.wago.com/2022-109/000-038



Item no.: 2022-109/000-039
1-conductor female plug; 2.5 mm²; 9-pole

www.wago.com/2022-109/000-039

Item no.: 2022-109/123-000
1-conductor female plug; Locking lever; 2.5 mm²; 9-pole

www.wago.com/2022-109/123-000

Item no.: 2022-109/135-000
1-conductor female plug; Strain relief plate; 2.5 mm²; 9-pole

www.wago.com/2022-109/135-000

Item no.: 2022-109/145-000
1-conductor female plug; Strain relief plate; 2.5 mm²; 9-pole

www.wago.com/2022-109/145-000

Item no.: 2022-110
1-conductor female plug; 2.5 mm²; 10-pole

www.wago.com/2022-110



Item no.: 2022-110/000-006
1-conductor female plug; 2.5 mm²; 10-pole

www.wago.com/2022-110/000-006



Item no.: 2022-110/000-016
1-conductor female plug; 2.5 mm²; 10-pole

www.wago.com/2022-110/000-016



Item no.: 2022-110/000-036
1-conductor female plug; 2.5 mm²; 10-pole

www.wago.com/2022-110/000-036

Item no.: 2022-110/000-037
1-conductor female plug; 2.5 mm²; 10-pole

www.wago.com/2022-110/000-037

















Item no.: 2022-110/000-038
1-conductor female plug; 2.5 mm²; 10-pole





www.wago.com/2022-110/000-038

Item no.: 2022-110/000-039
1-conductor female plug; 2.5 mm²; 10-pole

www.wago.com/2022-110/000-039

	Item no.: 2022-110/123-000 1-conductor female plug; Locking lever; 2.5 mm ² ; 10-pole	www.wago.com/2022-110/123-000
	Item no.: 2022-110/135-000 1-conductor female plug; Strain relief plate; 2.5 mm ² ; 10-pole	www.wago.com/2022-110/135-000
	Item no.: 2022-110/145-000 1-conductor female plug; Strain relief plate; 2.5 mm ² ; 10-pole	www.wago.com/2022-110/145-000
	Item no.: 2022-111 1-conductor female plug; 2.5 mm ² ; 11-pole	www.wago.com/2022-111
	Item no.: 2022-111/000-006 1-conductor female plug; 2.5 mm ² ; 11-pole	www.wago.com/2022-111/000-006
	Item no.: 2022-111/000-016 1-conductor female plug; 2.5 mm ² ; 11-pole	www.wago.com/2022-111/000-016
	Item no.: 2022-111/000-036 1-conductor female plug; 2.5 mm ² ; 11-pole	www.wago.com/2022-111/000-036
	Item no.: 2022-111/000-037 1-conductor female plug; 2.5 mm ² ; 11-pole	www.wago.com/2022-111/000-037
	Item no.: 2022-111/000-038 1-conductor female plug; 2.5 mm ² ; 11-pole	www.wago.com/2022-111/000-038
	Item no.: 2022-111/000-039 1-conductor female plug; 2.5 mm ² ; 11-pole	www.wago.com/2022-111/000-039
	Item no.: 2022-111/126-000 1-conductor female plug; Locking lever; 2.5 mm ² ; 11-pole	www.wago.com/2022-111/126-000
	Item no.: 2022-111/136-000 1-conductor female plug; Strain relief plate; 2.5 mm ² ; 11-pole	www.wago.com/2022-111/136-000
	Item no.: 2022-111/146-000 1-conductor female plug; Strain relief plate; 2.5 mm ² ; 11-pole	www.wago.com/2022-111/146-000
	Item no.: 2022-112 1-conductor female plug; 2.5 mm ² ; 12-pole	www.wago.com/2022-112
	Item no.: 2022-112/000-006 1-conductor female plug; 2.5 mm ² ; 12-pole	www.wago.com/2022-112/000-006

	<p>Item no.: 2022-112/000-016 1-conductor female plug; 2.5 mm²; 12-pole</p>	<p>www.wago.com/2022-112/000-016</p>
	<p>Item no.: 2022-112/000-036 1-conductor female plug; 2.5 mm²; 12-pole</p>	<p>www.wago.com/2022-112/000-036</p>
	<p>Item no.: 2022-112/000-037 1-conductor female plug; 2.5 mm²; 12-pole</p>	<p>www.wago.com/2022-112/000-037</p>
	<p>Item no.: 2022-112/000-038 1-conductor female plug; 2.5 mm²; 12-pole</p>	<p>www.wago.com/2022-112/000-038</p>
	<p>Item no.: 2022-112/000-039 1-conductor female plug; 2.5 mm²; 12-pole</p>	<p>www.wago.com/2022-112/000-039</p>
	<p>Item no.: 2022-112/126-000 1-conductor female plug; Locking lever; 2.5 mm²; 12-pole</p>	<p>www.wago.com/2022-112/126-000</p>
	<p>Item no.: 2022-112/136-000 1-conductor female plug; Strain relief plate; 2.5 mm²; 12-pole</p>	<p>www.wago.com/2022-112/136-000</p>
	<p>Item no.: 2022-112/146-000 1-conductor female plug; Strain relief plate; 2.5 mm²; 12-pole</p>	<p>www.wago.com/2022-112/146-000</p>
	<p>Item no.: 2022-113 1-conductor female plug; 2.5 mm²; 13-pole</p>	<p>www.wago.com/2022-113</p>
	<p>Item no.: 2022-113/000-006 1-conductor female plug; 2.5 mm²; 13-pole</p>	<p>www.wago.com/2022-113/000-006</p>
	<p>Item no.: 2022-113/000-016 1-conductor female plug; 2.5 mm²; 13-pole</p>	<p>www.wago.com/2022-113/000-016</p>
	<p>Item no.: 2022-113/000-036 1-conductor female plug; 2.5 mm²; 13-pole</p>	<p>www.wago.com/2022-113/000-036</p>
	<p>Item no.: 2022-113/000-037 1-conductor female plug; 2.5 mm²; 13-pole</p>	<p>www.wago.com/2022-113/000-037</p>
	<p>Item no.: 2022-113/000-038 1-conductor female plug; 2.5 mm²; 13-pole</p>	<p>www.wago.com/2022-113/000-038</p>
	<p>Item no.: 2022-113/000-039 1-conductor female plug; 2.5 mm²; 13-pole</p>	<p>www.wago.com/2022-113/000-039</p>

	Item no.: 2022-113/126-000 1-conductor female plug; Locking lever; 2.5 mm ² ; 13-pole	www.wago.com/2022-113/126-000
	Item no.: 2022-113/136-000 1-conductor female plug; Strain relief plate; 2.5 mm ² ; 13-pole	www.wago.com/2022-113/136-000
	Item no.: 2022-113/146-000 1-conductor female plug; Strain relief plate; 2.5 mm ² ; 13-pole	www.wago.com/2022-113/146-000
	Item no.: 2022-114 1-conductor female plug; 2.5 mm ² ; 14-pole	www.wago.com/2022-114
	Item no.: 2022-114/000-006 1-conductor female plug; 2.5 mm ² ; 14-pole	www.wago.com/2022-114/000-006
	Item no.: 2022-114/000-016 1-conductor female plug; 2.5 mm ² ; 14-pole	www.wago.com/2022-114/000-016
	Item no.: 2022-114/000-036 1-conductor female plug; 2.5 mm ² ; 14-pole	www.wago.com/2022-114/000-036
	Item no.: 2022-114/000-037 1-conductor female plug; 2.5 mm ² ; 14-pole	www.wago.com/2022-114/000-037
	Item no.: 2022-114/000-038 1-conductor female plug; 2.5 mm ² ; 14-pole	www.wago.com/2022-114/000-038
	Item no.: 2022-114/000-039 1-conductor female plug; 2.5 mm ² ; 14-pole	www.wago.com/2022-114/000-039
	Item no.: 2022-114/126-000 1-conductor female plug; Locking lever; 2.5 mm ² ; 14-pole	www.wago.com/2022-114/126-000
	Item no.: 2022-114/136-000 1-conductor female plug; Strain relief plate; 2.5 mm ² ; 14-pole	www.wago.com/2022-114/136-000
	Item no.: 2022-114/146-000 1-conductor female plug; Strain relief plate; 2.5 mm ² ; 14-pole	www.wago.com/2022-114/146-000
	Item no.: 2022-115 1-conductor female plug; 2.5 mm ² ; 15-pole	www.wago.com/2022-115
	Item no.: 2022-115/000-006 1-conductor female plug; 2.5 mm ² ; 15-pole	www.wago.com/2022-115/000-006



Item no.: 2022-115/000-016
1-conductor female plug; 2.5 mm²; 15-pole

www.wago.com/2022-115/000-016



Item no.: 2022-115/000-036
1-conductor female plug; 2.5 mm²; 15-pole

www.wago.com/2022-115/000-036

Item no.: 2022-115/000-037
1-conductor female plug; 2.5 mm²; 15-pole

www.wago.com/2022-115/000-037



Item no.: 2022-115/000-038
1-conductor female plug; 2.5 mm²; 15-pole

www.wago.com/2022-115/000-038

Item no.: 2022-115/000-039
1-conductor female plug; 2.5 mm²; 15-pole

www.wago.com/2022-115/000-039

Item no.: 2022-115/127-000
1-conductor female plug; Locking lever; 2.5 mm²; 15-pole

www.wago.com/2022-115/127-000

Item no.: 2022-115/137-000
1-conductor female plug; Strain relief plate; 2.5 mm²; 15-pole

www.wago.com/2022-115/137-000

Item no.: 2022-115/147-000
1-conductor female plug; Strain relief plate; 2.5 mm²; 15-pole

www.wago.com/2022-115/147-000

check



Item no.: 2002-511
Modular TOPJOB®S connector; modular; for jumper contact slot; 1-pole

www.wago.com/2002-511



Item no.: 2002-549
Spacer module; modular; e.g., for bridging commoned terminal blocks

www.wago.com/2002-549



Item no.: 2002-552
TOPJOB®S connector strip; for jumper contact slot; 2-pole

www.wago.com/2002-552



Item no.: 2002-553
TOPJOB®S connector strip; for jumper contact slot; 3-pole

www.wago.com/2002-553



Item no.: 2002-554
TOPJOB®S connector strip; for jumper contact slot; 4-pole

www.wago.com/2002-554



Item no.: 2002-555
TOPJOB®S connector strip; for jumper contact slot; 5-pole

www.wago.com/2002-555









Item no.: 2002-556
TOPJOB®S connector strip; for jumper contact slot; 6-pole

www.wago.com/2002-556











Item no.: 2002-557
TOPJOB®S connector strip; for jumper contact slot; 7-pole

www.wago.com/2002-557

	Item no.: 2002-558 TOPJOB®S connector strip; for jumper contact slot; 8-pole	www.wago.com/2002-558
	Item no.: 2002-559 TOPJOB®S connector strip; for jumper contact slot; 9-pole	www.wago.com/2002-559
	Item no.: 2002-560 TOPJOB®S connector strip; for jumper contact slot; 10-pole	www.wago.com/2002-560
	Item no.: 2009-174 Test plug adapter; for 4 mm Ø test plugs; for testing TOPJOB®S rail-mounted terminal blocks	www.wago.com/2009-174
	Item no.: 2009-182 Testing tap; for max. 2.5 mm ² ; tool-free connection for individual test wires 0.08 - 2.5 mm	www.wago.com/2009-182
	Item no.: 859-500 Test pin; 1 mm Ø; with solder connection for test wire	www.wago.com/859-500



Carrier rail











	Item no.: 210-112 Steel carrier rail; 35 x 7.5 mm; 1 mm thick; 2 m long; slotted; according to EN 60715; "Hole width 25 mm	www.wago.com/210-112
	Item no.: 210-113 Steel carrier rail; 35 x 7.5 mm; 1 mm thick; 2 m long; unslotted; according to EN 60715	www.wago.com/210-113
	Item no.: 210-114 Steel carrier rail; 35 x 15 mm; 1.5 mm thick; 2 m long; unslotted; similar to EN 60715	www.wago.com/210-114
	Item no.: 210-115 Steel carrier rail; 35 x 7.5 mm; 1 mm thick; 2 m long; slotted; according to EN 60715; "Hole width 18 mm	www.wago.com/210-115
	Item no.: 210-118 Steel carrier rail; 35 x 15 mm; 2.3 mm thick; 2 m long; unslotted; according to EN 60715	www.wago.com/210-118
	Item no.: 210-196 Aluminum carrier rail; 35 x 8.2 mm; 1.6 mm thick; 2 m long; unslotted; similar to EN 60715	www.wago.com/210-196
	Item no.: 210-197 Steel carrier rail; 35 x 15 mm; 1.5 mm thick; 2 m long; slotted; similar to EN 60715	www.wago.com/210-197
	Item no.: 210-198 Copper carrier rail; 35 x 15 mm; 2.3 mm thick; 2 m long; unslotted; according to EN 60715	www.wago.com/210-198

Coding







	Item no.: 2022-100 Carrier with 6 coding pins; for coding of female plugs	www.wago.com/2022-100
--	---	--

















General accessories

	Item no.: 2022-161 Start module for 1-conductor female connector; with integrated end plate; 2.5 mm ² ; 1-pole	www.wago.com/2022-161
	Item no.: 2022-162 Start module for 1-conductor female connector; with integrated end plate; 2.5 mm ² ; 1-pole	www.wago.com/2022-162

	Item no.: 2022-164 Start module for 1-conductor female connector; with integrated end plate; 2.5 mm ² ; 1-pole	www.wago.com/2022-164
	Item no.: 2022-167 Start module for 1-conductor female connector; with integrated end plate; 2.5 mm ² ; 1-pole	www.wago.com/2022-167
	Item no.: 2022-171 Center module for 1-conductor female connector; 2.5 mm ² ; 1-pole	www.wago.com/2022-171
	Item no.: 2022-172 Center module for 1-conductor female connector; 2.5 mm ² ; 1-pole	www.wago.com/2022-172
	Item no.: 2022-174 Center module for 1-conductor female connector; 2.5 mm ² ; 1-pole	www.wago.com/2022-174
	Item no.: 2022-177 Center module for 1-conductor female connector; 2.5 mm ² ; 1-pole	www.wago.com/2022-177
	Item no.: 2022-181 End module for 1-conductor female connector; 2.5 mm ² ; 1-pole	www.wago.com/2022-181
	Item no.: 2022-182 End module for 1-conductor female connector; 2.5 mm ² ; 1-pole	www.wago.com/2022-182
	Item no.: 2022-184 End module for 1-conductor female connector; 2.5 mm ² ; 1-pole	www.wago.com/2022-184
	Item no.: 2022-187 End module for 1-conductor female connector; 2.5 mm ² ; 1-pole	www.wago.com/2022-187

Marking accessories

	Item no.: 2002-161 Adaptor	www.wago.com/2002-161
	Item no.: 2009-110 Marking strips; on reel; not stretchable; plain; snap-on type	www.wago.com/2009-110
	Item no.: 2009-115 WMB-Inline; for smartPRINTER; on reel; stretchable 5 - 5.2 mm; plain; snap-on type	www.wago.com/2009-115
	Item no.: 2009-115/000-002 WMB-Inline; for smartPRINTER; on reel; stretchable 5 - 5.2 mm; plain; snap-on type	www.wago.com/2009-115/000-002
	Item no.: 2009-115/000-006 WMB-Inline; for smartPRINTER; on reel; stretchable 5 - 5.2 mm; plain; snap-on type	www.wago.com/2009-115/000-006
	Item no.: 2009-115/000-007 WMB-Inline; for smartPRINTER; on reel; stretchable 5 - 5.2 mm; plain; snap-on type	www.wago.com/2009-115/000-007
	Item no.: 2009-115/000-012 WMB-Inline; for smartPRINTER; on reel; stretchable 5 - 5.2 mm; plain; snap-on type	www.wago.com/2009-115/000-012

	<p>Item no.: 2009-115/000-017 WMB-Inline; for smartPRINTER; on reel; stretchable 5 - 5.2 mm; plain; snap-on type</p>	www.wago.com/2009-115/000-017
	<p>Item no.: 2009-115/000-023 WMB-Inline; for smartPRINTER; on reel; stretchable 5 - 5.2 mm; plain; snap-on type</p>	www.wago.com/2009-115/000-023
	<p>Item no.: 2009-115/000-024 WMB-Inline; for smartPRINTER; on reel; stretchable 5 - 5.2 mm; plain; snap-on type</p>	www.wago.com/2009-115/000-024
	<p>Item no.: 2009-145 Mini-WSB Inline; for smartPRINTER; on reel; stretchable 5 - 5.2 mm; plain; snap-on type</p>	www.wago.com/2009-145
	<p>Item no.: 2009-145/000-002 Mini-WSB Inline; for smartPRINTER; on reel; stretchable 5 - 5.2 mm; plain; snap-on type</p>	www.wago.com/2009-145/000-002
	<p>Item no.: 2009-145/000-005 Mini-WSB Inline; for smartPRINTER; on reel; stretchable 5 - 5.2 mm; plain; snap-on type</p>	www.wago.com/2009-145/000-005
	<p>Item no.: 2009-145/000-006 Mini-WSB Inline; for smartPRINTER; on reel; stretchable 5 - 5.2 mm; plain; snap-on type</p>	www.wago.com/2009-145/000-006
	<p>Item no.: 2009-145/000-007 Mini-WSB Inline; for smartPRINTER; on reel; stretchable 5 - 5.2 mm; plain; snap-on type</p>	www.wago.com/2009-145/000-007
	<p>Item no.: 2009-145/000-012 Mini-WSB Inline; for smartPRINTER; on reel; stretchable 5 - 5.2 mm; plain; snap-on type</p>	www.wago.com/2009-145/000-012
	<p>Item no.: 2009-145/000-023 Mini-WSB Inline; for smartPRINTER; on reel; stretchable 5 - 5.2 mm; plain; snap-on type</p>	www.wago.com/2009-145/000-023
	<p>Item no.: 2009-145/000-024 Mini-WSB Inline; on reel; stretchable 5 - 5.2 mm; plain; snap-on type</p>	www.wago.com/2009-145/000-024
	<p>Item no.: 2009-191 Group marker carrier</p>	www.wago.com/2009-191
	<p>Item no.: 2009-192 Group marker carrier</p>	www.wago.com/2009-192
	<p>Item no.: 2009-193 Group marker carrier</p>	www.wago.com/2009-193
	<p>Item no.: 2009-198 Adaptor</p>	www.wago.com/2009-198
	<p>Item no.: 248-501 Miniature WSB Quick marking system; plain; Marker width 5 mm; 10 strips with 10 markers per card</p>	www.wago.com/248-501



Item no.: 248-501/000-002
Mini-WSB marking card; as card; not stretchable; plain; snap-on type

www.wago.com/248-501/000-002



Item no.: 248-501/000-005
Mini-WSB marking card; as card; plain; snap-on type

www.wago.com/248-501/000-005



Item no.: 248-501/000-006
Mini-WSB marking card; as card; not stretchable; plain; snap-on type

www.wago.com/248-501/000-006



Item no.: 248-501/000-007
Mini-WSB marking card; as card; not stretchable; plain; snap-on type

www.wago.com/248-501/000-007



Item no.: 248-501/000-012
Mini-WSB marking card; as card; not stretchable; plain; snap-on type

www.wago.com/248-501/000-012



Item no.: 248-501/000-017
Mini-WSB marking card; as card; not stretchable; plain; snap-on type

www.wago.com/248-501/000-017



Item no.: 248-501/000-023
Mini-WSB marking card; as card; not stretchable; plain; snap-on type

www.wago.com/248-501/000-023



Item no.: 793-501
WMB marking card; as card; not stretchable; plain; snap-on type

www.wago.com/793-501



Item no.: 793-501/000-002
WMB marking card; as card; not stretchable; plain; snap-on type

www.wago.com/793-501/000-002



Item no.: 793-501/000-005
WMB marking card; as card; not stretchable; plain; snap-on type

www.wago.com/793-501/000-005



Item no.: 793-501/000-006
WMB marking card; as card; not stretchable; plain; snap-on type

www.wago.com/793-501/000-006



Item no.: 793-501/000-007
WMB marking card; as card; not stretchable; plain; snap-on type

www.wago.com/793-501/000-007



Item no.: 793-501/000-012
WMB marking card; as card; not stretchable; plain; snap-on type

www.wago.com/793-501/000-012



Item no.: 793-501/000-017
WMB marking card; as card; not stretchable; plain; snap-on type

www.wago.com/793-501/000-017



Item no.: 793-501/000-023
WMB marking card; as card; not stretchable; plain; snap-on type

www.wago.com/793-501/000-023



Item no.: 793-501/000-024
WMB marking card; as card; not stretchable; plain; snap-on type

www.wago.com/793-501/000-024



Item no.: 793-5501
WMB marking card; as card; for terminal block width 5 - 17.5 mm; stretchable 5 - 5.2 mm; plain; snap-on type

www.wago.com/793-5501



Item no.: 793-5501/000-002
WMB marking card; as card; for terminal block width 5 - 17.5 mm; stretchable 5 - 5.2 mm; plain; snap-on type

www.wago.com/793-5501/000-002



Item no.: 793-5501/000-005
WMB marking card; as card; stretchable 5 - 5.2 mm; plain; snap-on type

www.wago.com/793-5501/000-005



Item no.: 793-5501/000-006
WMB marking card; as card; stretchable 5 - 5.2 mm; plain; snap-on type

www.wago.com/793-5501/000-006



Item no.: 793-5501/000-007
WMB marking card; as card; stretchable 5 - 5.2 mm; plain; snap-on type

www.wago.com/793-5501/000-007



Item no.: 793-5501/000-012
WMB marking card; as card; stretchable 5 - 5.2 mm; plain; snap-on type

www.wago.com/793-5501/000-012



Item no.: 793-5501/000-017
WMB marking card; as card; stretchable 5 - 5.2 mm; plain; snap-on type

www.wago.com/793-5501/000-017



Item no.: 793-5501/000-023
WMB marking card; as card; stretchable 5 - 5.2 mm; plain; snap-on type

www.wago.com/793-5501/000-023



Item no.: 793-5501/000-024
WMB marking card; as card; stretchable 5 - 5.2 mm; plain; snap-on type

www.wago.com/793-5501/000-024

Insulation stop



Item no.: 2002-171
Insulation stop; 0.25 - 0.5 mm²; 5 pieces/strip

www.wago.com/2002-171



Item no.: 2002-172
Insulation stop; 0.75 - 1 mm²; 5 pieces/strip

www.wago.com/2002-172

ferrule



Item no.: 216-241
Ferrule; Sleeve for 0.5 mm² / AWG 22; insulated; electro-tin plated; electrolytic copper; gastight crimped; acc. to DIN 46228, Part 4/09.90

www.wago.com/216-241











Item no.: 216-242
Ferrule; Sleeve for 0.75 mm² / AWG 20; insulated; electro-tin plated; electrolytic copper; gastight crimped; acc. to DIN 46228, Part 4/09.90

www.wago.com/216-242

Item no.: 216-243
Ferrule; Sleeve for 1 mm² / AWG 18; insulated; electro-tin plated; electrolytic copper; gastight

www.wago.com/216-243

	crimped; acc. to DIN 46228, Part 4/09.90	
	Item no.: 216-244 Ferrule; Sleeve for 1.5 mm ² / AWG 16; insulated; electro-tin plated; electrolytic copper; gastight crimped; acc. to DIN 46228, Part 4/09.90	www.wago.com/216-244
	Item no.: 216-246 Ferrule; Sleeve for 2.5 mm ² / AWG 14; insulated; electro-tin plated; electrolytic copper; gastight crimped; acc. to DIN 46228, Part 4/09.90	www.wago.com/216-246
	Item no.: 216-262 Ferrule; Sleeve for 0.75 mm ² / AWG 20; insulated; electro-tin plated; electrolytic copper; gastight crimped; acc. to DIN 46228, Part 4/09.90	www.wago.com/216-262
	Item no.: 216-263 Ferrule; Sleeve for 1 mm ² / AWG 18; insulated; electro-tin plated; electrolytic copper; gastight crimped; acc. to DIN 46228, Part 4/09.90	www.wago.com/216-263
	Item no.: 216-264 Ferrule; Sleeve for 1.5 mm ² / AWG 16; insulated; electro-tin plated; electrolytic copper; gastight crimped; acc. to DIN 46228, Part 4/09.90	www.wago.com/216-264
	Item no.: 216-266 Ferrule; Sleeve for 2.5 mm ² / AWG 14; insulated; electro-tin plated; electrolytic copper; gastight crimped; acc. to DIN 46228, Part 4/09.90	www.wago.com/216-266
	Item no.: 216-284 Ferrule; Sleeve for 1.5 mm ² / AWG 16; insulated; electro-tin plated; electrolytic copper; gastight crimped; acc. to DIN 46228, Part 4/09.90	www.wago.com/216-284
	Item no.: 216-286 Ferrule; Sleeve for 2.5 mm ² / AWG 14; insulated; electro-tin plated; electrolytic copper; gastight crimped; acc. to DIN 46228, Part 4/09.90	www.wago.com/216-286

Downloads

Documentation

Bid Text

2022-1304	Aug 15, 2018	DOCX 15.5 kB	Download
-----------	--------------	-----------------	----------

smartDATA

CAD data

3D Download 2022-1304	URL	Download
-----------------------	-----	----------

Product family

X-COM S

[Show all products from the family](#)



Subject to changes.

WAGO Kontakttechnik GmbH & Co. KG
Hansastr. 27
32423 Minden
Phone: +49571 887-0 | Fax: +49571 887-169
Email: info.de@wago.com | Web: www.wago.com

Do you have any questions about our products?
We are always happy to take your call at +49 (571) 887-44222.