

**Data sheet | Item number: 231-164/003-000**

Male connector for rail-mount terminal blocks; 1.2 x 1.2 mm pins; straight;

Pin spacing 5 mm; 4-pole

[www.wago.com/231-164/003-000](http://www.wago.com/231-164/003-000)

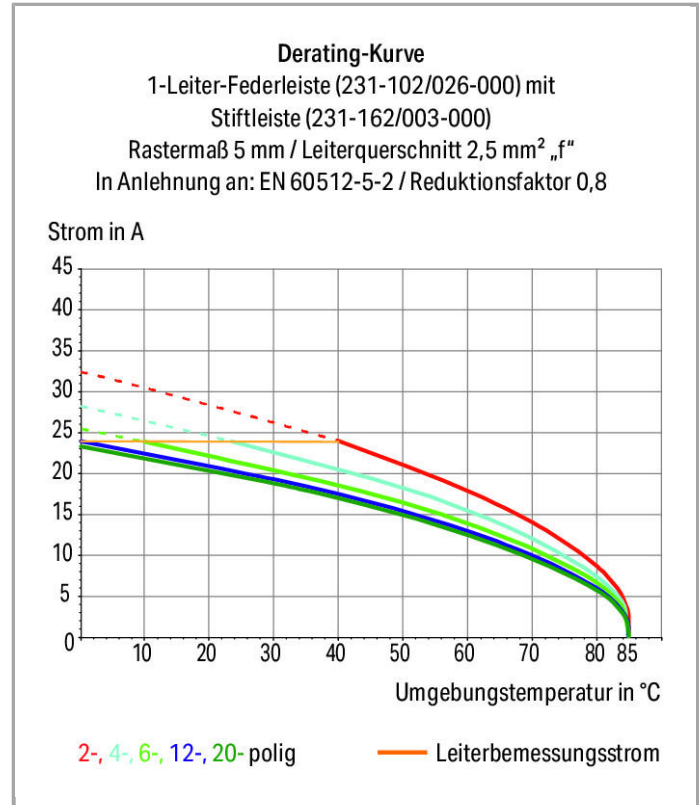
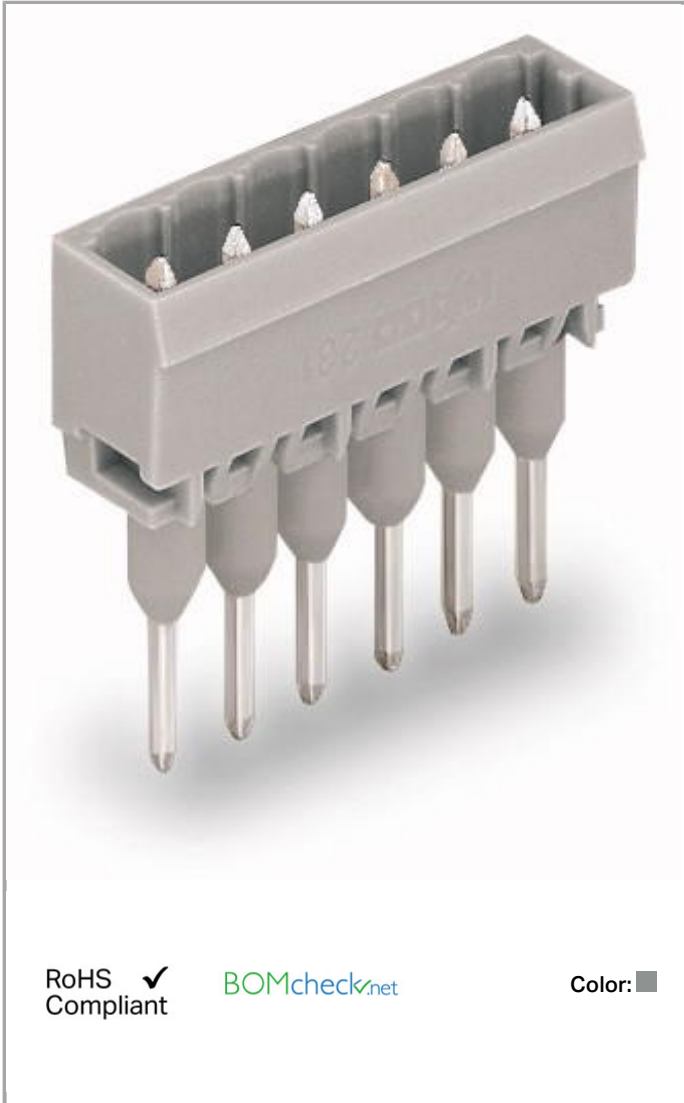

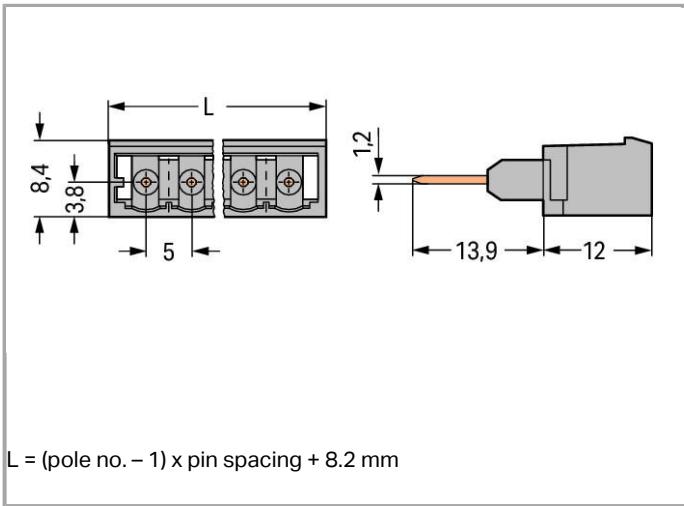

### Item description

- Pluggable connectors for rail-mount terminal blocks equipped with CAGE CLAMP® connection
- Male connectors with long contact pins connect to the termination ports of 280 Series Rail-Mount Terminal Blocks
- Pins can be touched when the connector is unplugged, so power supply should be performed via terminal block (observe rated voltage!)
- With coding fingers

Other variants can be requested via the WAGO sales department or, if necessary, configured at <https://configurator.wago.com/>: Other pole numbers

### Data

#### Electrical data

#### Ratings per IEC/EN 60664-1

Rated voltage (III / 3)	250 V
Rated impulse voltage (III / 3)	4 kV
Rated voltage (III / 2)	320 V
Rated impulse voltage (III / 2)	4 kV
Rated voltage (II / 2)	630 V
Rated impulse voltage (II / 2)	4 kV
Rated current	16 A
Legend (ratings)	(III / 2) ≙ Overvoltage category III / Pollution degree 2

#### Approvals per UL 1059

Rated voltage UL (Use Group B)	300 V
Rated current UL (Use Group B)	15 A
Rated voltage UL (Use Group D)	300 V
Rated current UL (Use Group D)	10 A



## Approvals per CSA

Rated voltage CSA (Use Group B)	300 V
Rated current CSA (Use Group B)	15 A
Rated voltage CSA (Use Group D)	300 V
Rated current CSA (Use Group D)	10 A

## Connection data

No. of poles	4
Total number of potentials	4
Number of levels	1

## Geometrical Data

Pin spacing	5 mm (0.197 inch)
Width	23.2 mm / 0.913 inch
Height	25.9 mm / 1.02 inch
Height from the surface	12 mm / 0.472 inch
Depth	8.4 mm / 0.331 inch

## Plug connection

Contact type (pluggable connector)	Male connector/plug
Connector connection type	for front-entry wiring terminal block
Mismating protection	No

## Material Data

Color	gray
Material group	I
Insulating material	Polyamide 66 (PA 66)
Flammability class per UL94	V0
Contact material	Electrolytic copper (Ecu)
Contact plating	tin-plated
Fire load	0.034 MJ
Weight	2.424 g

## Environmental Requirements

Limit temperature range	-60 ... +100 °C
-------------------------	-----------------



## Commercial data

Country of origin	PL
GTIN	4044918905183



Customs Tariff No.	85366990990
Product Group	3 (Multi Conn. System)

## Approvals / Certificates

### Country specific Approvals

Logo	Approval	Certificate name
	<b>CB</b> DEKRA Certification B.V.	NL-39756
	<b>CSA</b> DEKRA Certification B.V.	1466354
	<b>CSA</b> DEKRA Certification B.V.	1466354

### Ship Approvals

Logo	Approval	Certificate name
	<b>ABS</b> American Bureau of Shipping	14-HG1241537-PDA
	<b>DNV GL</b> Det Norske Veritas, Germanischer Lloyd	TAE000016Z

### UL-Approvals

Logo	Approval	Certificate name
	<b>UL</b> UL International Germany GmbH	E45172
	<b>UR</b> UL International Germany GmbH	E45171
	<b>UR</b> UL International Germany GmbH	E45171

### Compatible products

#### Coding



**Item no.: 231-129**  
Coding key; snap-on type

[www.wago.com/231-129](http://www.wago.com/231-129)



**Item no.: 231-500**  
Spacer; for formation of groups

[www.wago.com/231-500](http://www.wago.com/231-500)

#### Marking accessories



**Item no.: 210-833**  
Marking strips; on reel; 6 mm wide; plain; Self-adhesive

[www.wago.com/210-833](http://www.wago.com/210-833)



**Item no.: 210-834**  
Marking strips; on reel; 5 mm wide; plain; Self-adhesive

[www.wago.com/210-834](http://www.wago.com/210-834)

#### Downloads

##### smartDATA

##### CAD data

3D Download 231-164/003-000

URL

Download

Subject to changes.