

Data sheet | Item number: 231-166/003-000

Male connector for rail-mount terminal blocks; 1.2 x 1.2 mm pins; straight;

Pin spacing 5 mm; 6-pole

www.wago.com/231-166/003-000

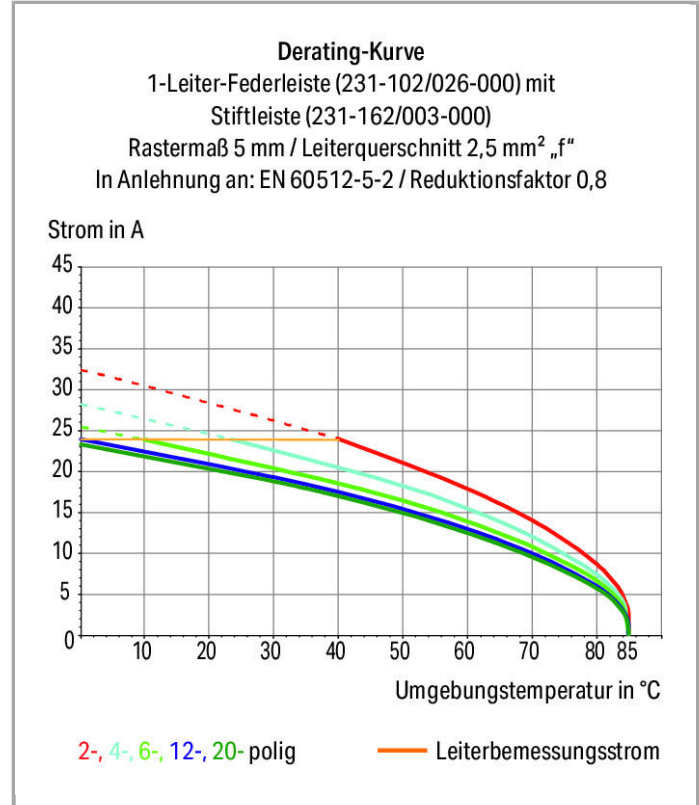
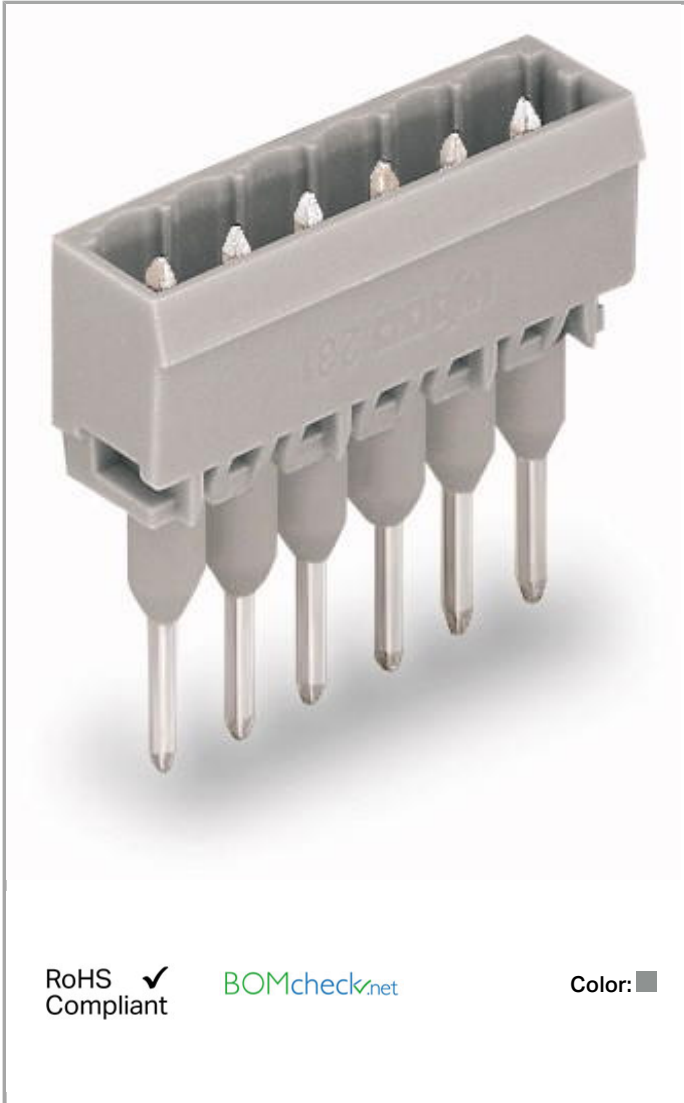

RoHS Compliant

BOMcheck.net

Color: ■

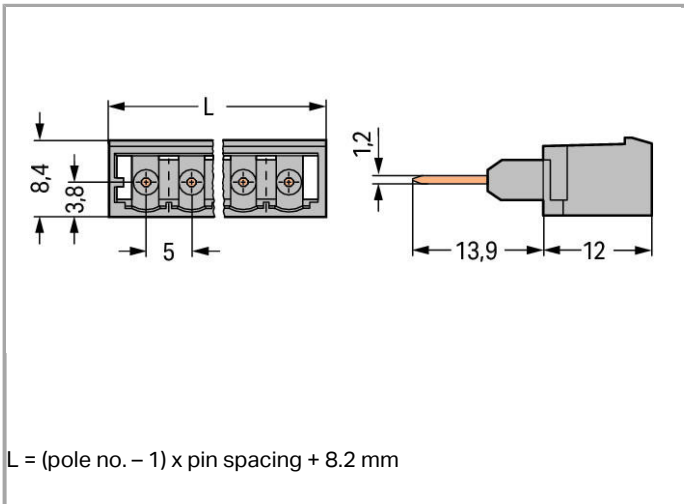

Item description

- Pluggable connectors for rail-mount terminal blocks equipped with CAGE CLAMP® connection
- Male connectors with long contact pins connect to the termination ports of 280 Series Rail-Mount Terminal Blocks
- Pins can be touched when the connector is unplugged, so power supply should be performed via terminal block (observe rated voltage!)
- With coding fingers

Other variants can be requested via the WAGO sales department or, if necessary, configured at <https://configurator.wago.com/>: Other pole numbers

Data

Electrical data

Ratings per IEC/EN 60664-1

Rated voltage (III / 3)	250 V
Rated impulse voltage (III / 3)	4 kV
Rated voltage (III / 2)	320 V
Rated impulse voltage (III / 2)	4 kV
Rated voltage (II / 2)	630 V
Rated impulse voltage (II / 2)	4 kV
Rated current	16 A
Legend (ratings)	(III / 2) ≙ Overvoltage category III / Pollution degree 2

Approvals per UL 1059

Rated voltage UL (Use Group B)	300 V
Rated current UL (Use Group B)	15 A
Rated voltage UL (Use Group D)	300 V
Rated current UL (Use Group D)	10 A



Approvals per CSA

Rated voltage CSA (Use Group B)	300 V
Rated current CSA (Use Group B)	15 A
Rated voltage CSA (Use Group D)	300 V
Rated current CSA (Use Group D)	10 A

Connection data

No. of poles	6
Total number of potentials	6
Number of levels	1

Geometrical Data

Pin spacing	5 mm (0.197 inch)
Width	33.2 mm / 1.307 inch
Height	25.9 mm / 1.02 inch
Height from the surface	12 mm / 0.472 inch
Depth	8.4 mm / 0.331 inch

Plug connection

Contact type (pluggable connector)	Male connector/plug
Connector connection type	for front-entry wiring terminal block
Mismating protection	No

Material Data

Color	gray
Material group	I
Insulating material	Polyamide 66 (PA 66)
Flammability class per UL94	V0
Contact material	Electrolytic copper (Ecu)
Contact plating	tin-plated
Fire load	0.048 MJ
Weight	3.474 g

Environmental Requirements

Limit temperature range	-60 ... +100 °C
-------------------------	-----------------

Commercial data

Country of origin	DE
GTIN	4044918905220

Customs Tariff No.

85366990990

Product Group



3 (Multi Conn. System)

Approvals / Certificates



Country specific Approvals

Logo	Approval	Certificate name
	CB DEKRA Certification B.V.	NL-39756
	CSA DEKRA Certification B.V.	1466354

Ship Approvals

Logo	Approval	Certificate name
	ABS American Bureau of Shipping	14-HG1241537-PDA
	DNV GL Det Norske Veritas, Germanischer Lloyd	TAE000016Z

UL-Approvals

Logo	Approval	Certificate name
	UL UL International Germany GmbH	E45172
	UR UL International Germany GmbH	E45171
	UR UL International Germany GmbH	E45171

Compatible products

Coding

	Item no.: 231-129 Coding key; snap-on type	www.wago.com/231-129
	Item no.: 231-500 Spacer; for formation of groups	www.wago.com/231-500

Marking accessories



Item no.: 210-833

Marking strips; on reel; 6 mm wide; plain; Self-adhesive

www.wago.com/210-833



Item no.: 210-834

Marking strips; on reel; 5 mm wide; plain; Self-adhesive

www.wago.com/210-834

Downloads

smartDATA

CAD data

3D Download 231-166/003-000

URL

Download

Subject to changes.

WAGO Kontakttechnik GmbH & Co. KG

Hansastr. 27

32423 Minden

Phone: +49571 887-0 | Fax: +49571 887-169

Email: info.de@wago.com | Web: www.wago.com

Do you have any questions about our products?

We are always happy to take your call at +49 (571) 887-44222.