

## Data sheet | Item number: 231-2105/037-000

2-conductor female connector; Locking lever; 2.5 mm<sup>2</sup>; Pin spacing 5 mm; 5-pole

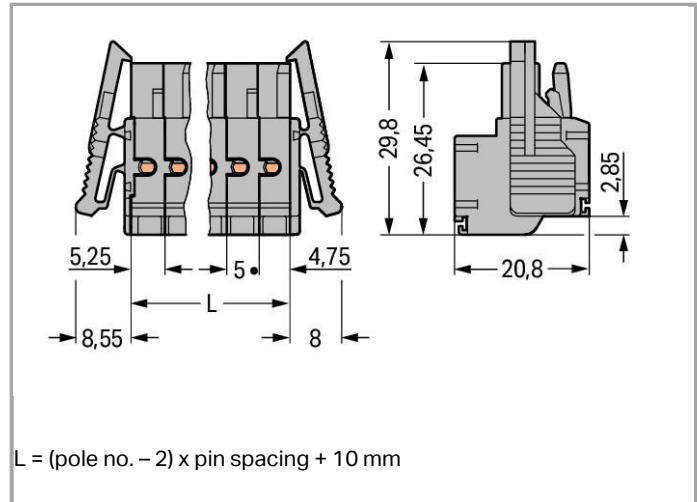

[www.wago.com/231-2105/037-000](http://www.wago.com/231-2105/037-000)

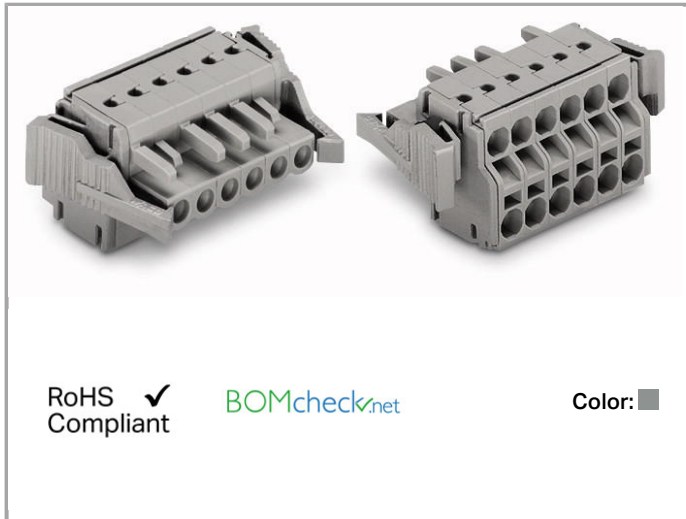

### Item description

- Universal connection for all conductor types
- Two conductor entries per pole
- For looping through power or data buses
- Bus connection is retained, even when unmated
- Push-in termination of solid and ferruled conductors
- With coding fingers

Other variants can be requested via the WAGO sales department or, if necessary, configured at <https://configurator.wago.com/>: Gold-plated or partially gold-plated contact surfaces

### Data

#### Electrical data

#### Ratings per IEC/EN 60664-1

Rated voltage (III / 3)	320 V
Rated impulse voltage (III / 3)	4 kV
Rated voltage (III / 2)	320 V
Rated impulse voltage (III / 2)	4 kV
Rated voltage (II / 2)	630 V
Rated impulse voltage (II / 2)	4 kV
Rated current	16 A
Legend (ratings)	(III / 2) $\hat{=}$ Overvoltage category III / Pollution degree 2

### Approvals per UL 1059

Rated voltage UL (Use Group B)	300 V
Rated current UL (Use Group B)	20 A
Rated voltage UL (Use Group D)	300 V
Rated current UL (Use Group D)	10 A

### Approvals per CSA

Rated voltage CSA (Use Group B)	300 V
Rated current CSA (Use Group B)	15 A
Rated voltage CSA (Use Group D)	300 V
Rated current CSA (Use Group D)	10 A

### Connection data

Connection technology	Push-in CAGE CLAMP®
Actuation type	Operating tool
Solid conductor	0.2 ... 2.5 mm <sup>2</sup> / 24 ... 12 AWG
Fine-stranded conductor	0.2 ... 2.5 mm <sup>2</sup> / 24 ... 12 AWG
Fine-stranded conductor with ferrule with plastic collar	0.25 ... 1.5 mm <sup>2</sup>
Fine-stranded conductor with ferrule without plastic collar	0.25 ... 2.5 mm <sup>2</sup>
Strip length	9 ... 10 mm / 0.35 ... 0.39 Inch
No. of poles	5
Total number of connection points	10
Total number of potentials	5
Number of connection types	1
Number of levels	1
Conductor entry direction to mating direction	0°

### Geometrical Data

Pin spacing	5 mm (0.197 inch)
Width	41.55 mm / 1.636 inch
Height	20.8 mm / 0.819 inch
Depth	29.8 mm / 1.173 inch

### Plug connection

Contact type (pluggable connector)	Female connector/socket
Connector connection type	for conductors
Mismating protection	No
Locking of plug-in connection	locking lever

## Material Data

Color	gray
Material group	I
Insulating material	Polyamide 66 (PA 66)
Flammability class per UL94	V0
Clamping spring material	Chrome nickel spring steel (CrNi)
Contact material	Copper alloy
Contact plating	tin-plated
Fire load	0.229 MJ
Weight	12.78 g

## Environmental Requirements

Limit temperature range	-60 ... +85 °C
-------------------------	----------------

## Commercial data



Country of origin	PL
GTIN	4044918563000
Customs Tariff No.	85366990990
Product Group	3 (Multi Conn. System)

## Approvals / Certificates

### Country specific Approvals

Logo	Approval	Certificate name
	<b>CB</b> DEKRA Certification B.V.	NL-39756

### Ship Approvals

Logo	Approval	Certificate name
	<b>ABS</b> American Bureau of Shipping	14-HG1241537-PDA
	<b>DNV GL</b> Det Norske Veritas, Germanischer Lloyd	TAE000016Z

### UL-Approvals

Logo	Approval	Certificate name
	<b>UL</b> UL International Germany GmbH	E45171





UL  
Underwriters Laboratories Inc.

E45172 Sec. 44

## Compatible products

### Insulation stop

	<b>Item no.:</b> 231-670 Insulation stop; 0.08-0.2 mm <sup>2</sup> / 0.2 mm <sup>2</sup> "s"	<a href="http://www.wago.com/231-670">www.wago.com/231-670</a>
	<b>Item no.:</b> 231-671 Insulation stop; 0.25 - 0.5 mm <sup>2</sup>	<a href="http://www.wago.com/231-671">www.wago.com/231-671</a>
	<b>Item no.:</b> 231-672 Insulation stop; 0.75 - 1 mm <sup>2</sup>	<a href="http://www.wago.com/231-672">www.wago.com/231-672</a>









### Strain relief plate

	<b>Item no.:</b> 734-329 Strain relief plate	<a href="http://www.wago.com/734-329">www.wago.com/734-329</a>
--	---	--

### Marking accessories

	<b>Item no.:</b> 210-833 Marking strips; on reel; 6 mm wide; plain; Self-adhesive	<a href="http://www.wago.com/210-833">www.wago.com/210-833</a>
	<b>Item no.:</b> 210-834 Marking strips; on reel; 5 mm wide; plain; Self-adhesive	<a href="http://www.wago.com/210-834">www.wago.com/210-834</a>

### tools

	<b>Item no.:</b> 209-130 Operating tool; suitable for 264, 280 and 281 Series; 1-way; of insulating material	<a href="http://www.wago.com/209-130">www.wago.com/209-130</a>
	<b>Item no.:</b> 210-657 Operating tool with partially insulated shaft; Blade (3.5 x 0.5) mm; short	<a href="http://www.wago.com/210-657">www.wago.com/210-657</a>
	<b>Item no.:</b> 210-720 Operating tool with partially insulated shaft; Type 2, blade (3.5 x 0.5) mm	<a href="http://www.wago.com/210-720">www.wago.com/210-720</a>
	<b>Item no.:</b> 280-432 Operating tool; of insulating material; 2-way	<a href="http://www.wago.com/280-432">www.wago.com/280-432</a>
	<b>Item no.:</b> 280-433 Operating tool; of insulating material; 3-way	<a href="http://www.wago.com/280-433">www.wago.com/280-433</a>
	<b>Item no.:</b> 280-434 Operating tool; of insulating material; 4-way	<a href="http://www.wago.com/280-434">www.wago.com/280-434</a>
	<b>Item no.:</b> 280-435 Operating tool; of insulating material; 5-way	<a href="http://www.wago.com/280-435">www.wago.com/280-435</a>
	<b>Item no.:</b> 280-436 Operating tool; of insulating material; 6-way	<a href="http://www.wago.com/280-436">www.wago.com/280-436</a>



**Item no.: 280-437**  
Operating tool; of insulating material; 7-way

[www.wago.com/280-437](http://www.wago.com/280-437)

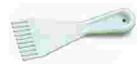

**Item no.: 280-438**  
Operating tool; of insulating material; 8-way

[www.wago.com/280-438](http://www.wago.com/280-438)

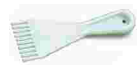

**Item no.: 280-440**  
Operating tool; of insulating material; 10-way

[www.wago.com/280-440](http://www.wago.com/280-440)

#### ferrule



**Item no.: 216-101**  
Ferrule; Sleeve for 0.5 mm<sup>2</sup> / AWG 22; uninsulated; electro-tin plated

[www.wago.com/216-101](http://www.wago.com/216-101)



**Item no.: 216-102**  
Ferrule; Sleeve for 0.75 mm<sup>2</sup> / AWG 20; uninsulated; electro-tin plated

[www.wago.com/216-102](http://www.wago.com/216-102)



**Item no.: 216-103**  
Ferrule; Sleeve for 1 mm<sup>2</sup> / AWG 18; uninsulated; electro-tin plated

[www.wago.com/216-103](http://www.wago.com/216-103)



**Item no.: 216-104**  
Ferrule; Sleeve for 1.5 mm<sup>2</sup> / AWG 16; uninsulated; electro-tin plated

[www.wago.com/216-104](http://www.wago.com/216-104)



**Item no.: 216-106**  
Ferrule; Sleeve for 2.5 mm<sup>2</sup> / AWG 14; uninsulated; electro-tin plated

[www.wago.com/216-106](http://www.wago.com/216-106)



**Item no.: 216-121**  
Ferrule; Sleeve for 0.5 mm<sup>2</sup> / AWG 22; uninsulated; electro-tin plated

[www.wago.com/216-121](http://www.wago.com/216-121)



**Item no.: 216-122**  
Ferrule; Sleeve for 0.75 mm<sup>2</sup> / AWG 20; uninsulated; electro-tin plated

[www.wago.com/216-122](http://www.wago.com/216-122)



**Item no.: 216-123**  
Ferrule; Sleeve for 1 mm<sup>2</sup> / AWG 18; uninsulated; electro-tin plated

[www.wago.com/216-123](http://www.wago.com/216-123)



**Item no.: 216-124**  
Ferrule; Sleeve for 1.5 mm<sup>2</sup> / AWG 16; uninsulated; electro-tin plated

[www.wago.com/216-124](http://www.wago.com/216-124)



**Item no.: 216-131**  
Ferrule; Sleeve for 0.25 mm<sup>2</sup> / AWG 24; uninsulated; electro-tin plated

[www.wago.com/216-131](http://www.wago.com/216-131)



**Item no.: 216-132**  
Ferrule; Sleeve for 0.34 mm<sup>2</sup> / AWG 24; uninsulated; electro-tin plated

[www.wago.com/216-132](http://www.wago.com/216-132)



**Item no.: 216-141**  
Ferrule; Sleeve for 0.5 mm<sup>2</sup> / AWG 22; uninsulated; electro-tin plated; electrolytic copper; gastight crimped; acc. to DIN 46228, Part 1/08.92

[www.wago.com/216-141](http://www.wago.com/216-141)



**Item no.: 216-142**  
Ferrule; Sleeve for 0.75 mm<sup>2</sup> / AWG 20; uninsulated; electro-tin plated; electrolytic copper; gastight crimped; acc. to DIN 46228, Part 1/08.92

[www.wago.com/216-142](http://www.wago.com/216-142)





















**Item no.: 216-143**  
Ferrule; Sleeve for 1 mm<sup>2</sup> / AWG 18; uninsulated; electro-tin plated; electrolytic copper; gastight crimped; acc. to DIN 46228, Part 1/08.92





[www.wago.com/216-143](http://www.wago.com/216-143)



**Item no.: 216-144**  
Ferrule; Sleeve for 1.5 mm<sup>2</sup> / AWG 16; uninsulated; electro-tin plated; electrolytic copper; gastight crimped; acc. to DIN 46228, Part 1/08.92

[www.wago.com/216-144](http://www.wago.com/216-144)

	<b>Item no.: 216-151</b> Ferrule; Sleeve for 0.25 mm <sup>2</sup> / AWG 24; uninsulated; electro-tin plated	<a href="http://www.wago.com/216-151">www.wago.com/216-151</a>
	<b>Item no.: 216-152</b> Ferrule; Sleeve for 0.34 mm <sup>2</sup> / AWG 24; uninsulated; electro-tin plated	<a href="http://www.wago.com/216-152">www.wago.com/216-152</a>
	<b>Item no.: 216-201</b> Ferrule; Sleeve for 0.5 mm <sup>2</sup> / AWG 22; insulated; electro-tin plated	<a href="http://www.wago.com/216-201">www.wago.com/216-201</a>
	<b>Item no.: 216-202</b> Ferrule; Sleeve for 0.75 mm <sup>2</sup> / AWG 20; insulated; electro-tin plated	<a href="http://www.wago.com/216-202">www.wago.com/216-202</a>
	<b>Item no.: 216-203</b> Ferrule; Sleeve for 1 mm <sup>2</sup> / AWG 18; insulated; electro-tin plated	<a href="http://www.wago.com/216-203">www.wago.com/216-203</a>
	<b>Item no.: 216-204</b> Ferrule; Sleeve for 1.5 mm <sup>2</sup> / AWG 16; insulated; electro-tin plated	<a href="http://www.wago.com/216-204">www.wago.com/216-204</a>
	<b>Item no.: 216-221</b> Ferrule; Sleeve for 0.5 mm <sup>2</sup> / AWG 22; insulated; electro-tin plated	<a href="http://www.wago.com/216-221">www.wago.com/216-221</a>
	<b>Item no.: 216-222</b> Ferrule; Sleeve for 0.75 mm <sup>2</sup> / AWG 20; insulated; electro-tin plated	<a href="http://www.wago.com/216-222">www.wago.com/216-222</a>
	<b>Item no.: 216-223</b> Ferrule; Sleeve for 1 mm <sup>2</sup> / AWG 18; insulated; electro-tin plated	<a href="http://www.wago.com/216-223">www.wago.com/216-223</a>
	<b>Item no.: 216-224</b> Ferrule; Sleeve for 1.5 mm <sup>2</sup> / AWG 16; insulated; electro-tin plated	<a href="http://www.wago.com/216-224">www.wago.com/216-224</a>
	<b>Item no.: 216-241</b> Ferrule; Sleeve for 0.5 mm <sup>2</sup> / AWG 22; insulated; electro-tin plated; electrolytic copper; gastight crimped; acc. to DIN 46228, Part 4/09.90	<a href="http://www.wago.com/216-241">www.wago.com/216-241</a>
	<b>Item no.: 216-242</b> Ferrule; Sleeve for 0.75 mm <sup>2</sup> / AWG 20; insulated; electro-tin plated; electrolytic copper; gastight crimped; acc. to DIN 46228, Part 4/09.90	<a href="http://www.wago.com/216-242">www.wago.com/216-242</a>
	<b>Item no.: 216-243</b> Ferrule; Sleeve for 1 mm <sup>2</sup> / AWG 18; insulated; electro-tin plated; electrolytic copper; gastight crimped; acc. to DIN 46228, Part 4/09.90	<a href="http://www.wago.com/216-243">www.wago.com/216-243</a>
	<b>Item no.: 216-244</b> Ferrule; Sleeve for 1.5 mm <sup>2</sup> / AWG 16; insulated; electro-tin plated; electrolytic copper; gastight crimped; acc. to DIN 46228, Part 4/09.90	<a href="http://www.wago.com/216-244">www.wago.com/216-244</a>
	<b>Item no.: 216-262</b> Ferrule; Sleeve for 0.75 mm <sup>2</sup> / AWG 20; insulated; electro-tin plated; electrolytic copper; gastight crimped; acc. to DIN 46228, Part 4/09.90	<a href="http://www.wago.com/216-262">www.wago.com/216-262</a>
	<b>Item no.: 216-263</b> Ferrule; Sleeve for 1 mm <sup>2</sup> / AWG 18; insulated; electro-tin plated; electrolytic copper; gastight crimped; acc. to DIN 46228, Part 4/09.90	<a href="http://www.wago.com/216-263">www.wago.com/216-263</a>
	<b>Item no.: 216-264</b> Ferrule; Sleeve for 1.5 mm <sup>2</sup> / AWG 16; insulated; electro-tin plated; electrolytic copper; gastight crimped; acc. to DIN 46228, Part 4/09.90	<a href="http://www.wago.com/216-264">www.wago.com/216-264</a>
	<b>Item no.: 216-284</b> Ferrule; Sleeve for 1.5 mm <sup>2</sup> / AWG 16; insulated; electro-tin plated; electrolytic copper; gastight crimped; acc. to DIN 46228, Part 4/09.90	<a href="http://www.wago.com/216-284">www.wago.com/216-284</a>
	<b>Item no.: 216-301</b> Ferrule; Sleeve for 0.25 mm <sup>2</sup> / AWG 24; insulated; electro-tin plated	<a href="http://www.wago.com/216-301">www.wago.com/216-301</a>

	<b>Item no.: 216-302</b> Ferrule; Sleeve for 0.34 mm <sup>2</sup> / AWG 24; insulated; electro-tin plated	<a href="http://www.wago.com/216-302">www.wago.com/216-302</a>
	<b>Item no.: 216-321</b> Ferrule; Sleeve for 0.25 mm <sup>2</sup> / AWG 24; insulated; electro-tin plated	<a href="http://www.wago.com/216-321">www.wago.com/216-321</a>
	<b>Item no.: 216-322</b> Ferrule; Sleeve for 0.34 mm <sup>2</sup> / AWG 24; insulated; electro-tin plated	<a href="http://www.wago.com/216-322">www.wago.com/216-322</a>
<b>check</b>		
	<b>Item no.: 231-661</b> Test plugs for female connectors; for 5 mm and 5.08 mm pin spacing	<a href="http://www.wago.com/231-661">www.wago.com/231-661</a>

Downloads  
smartDATA

CAD data

	URL	Download
3D Download 231-2105/037-000		

Subject to changes.