

Data sheet | Item number: 243-804

MICRO PUSH WIRE® connector for junction boxes; 4-conductor terminal block

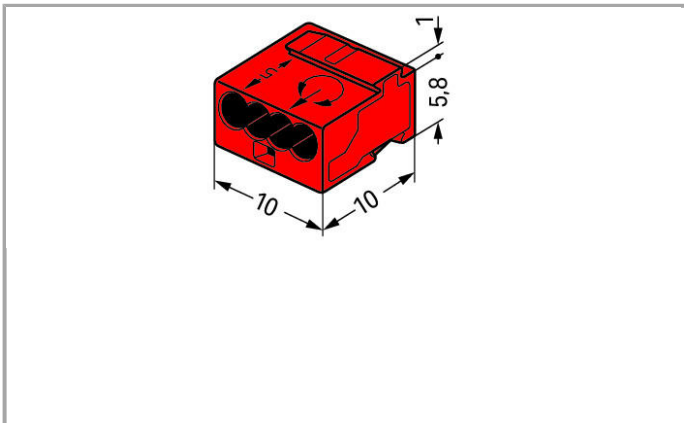

www.wago.com/243-804

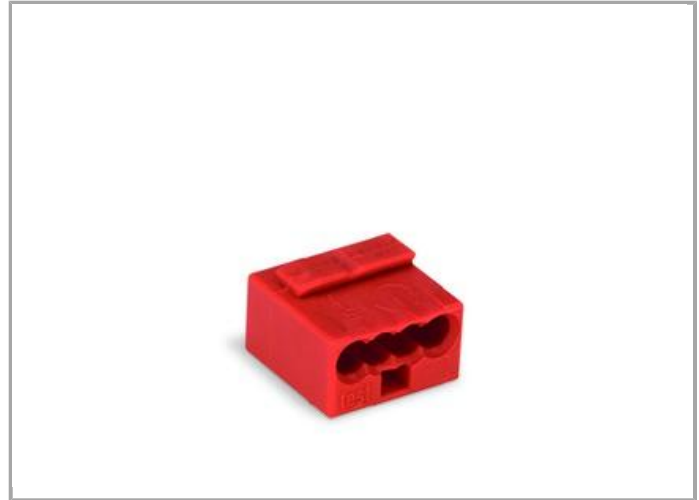

Data

Electrical data

Ratings per IEC/EN 60664-1

Rated voltage (II / 2)	100 V
Rated impulse voltage (II / 2)	1.5 kV
Rated current	6 A
Legend (ratings)	(II / 2) ≙ Overvoltage category II / Pollution degree 2

Connection data

Connection technology	PUSH WIRE®
Actuation type	Push-in
Connectable conductor materials	Copper
Conductor diameter	0.6 ... 0.8 mm / ... AWG
Strip length	5 ... 6 mm / 0.2 ... 0.24 Inch
Total number of connection points	4
Total number of potentials	1
Number of connection types	1
Number of levels	1
Type of wiring	Side-entry wiring

Geometrical Data

Width	10 mm / 0.394 inch
Height	6.8 mm / 0.268 inch
Depth	10 mm / 0.394 inch

Material Data

Color	red
Fire load	0.012 MJ
Weight	0.755 g

Environmental Requirements



Surrounding air (operating) temperature	60 °C
---	-------

Commercial data

Country of origin	DE
GTIN	4044918441025
Customs Tariff No.	85369010000



Approvals / Certificates

Country specific Approvals

Logo	Approval	Certificate name
	CCA DEKRA Certification B.V.	NTR NL 7486
	CSA DEKRA Certification B.V.	70048857

	CSA DEKRA Certification B.V.	70048857
	KEMA/KEUR DEKRA Certification B.V.	2193300.01

Ship Approvals



Logo	Approval	Certificate name
	ABS American Bureau of Shipping	15-HG1419918-PDA
	LR Lloyds Register	04/20013 (E4)

UL-Approvals

Logo	Approval	Certificate name
	UR Underwriters Laboratories Inc.	E45172

Compatible products

General accessories

	Item no.: 243-112 Mounting carrier; for 4 connectors; 243 Series; for DIN-35 rail mounting/screw mounting	www.wago.com/243-112
	Item no.: 243-113 Mounting carrier; for 6 connectors; 243 Series; for DIN-35 rail mounting/screw mounting	www.wago.com/243-113
	Item no.: 249-130 Syringe; Contents: 20 ml Alu-Plus contact paste	www.wago.com/249-130

Marking accessories

	Item no.: 210-332/575-103 Marking strips; as a DIN A4 sheet; MARKED; 1-12 (160x); Height of marker strip: 3 mm; Strip length 182 mm; Horizontal marking; Self-adhesive	www.wago.com/210-332/575-103
--	---	--

Downloads

Documentation



Bid Text

243-804	Oct 10, 2017	DOC 25.6 kB	Download
---------	--------------	----------------	----------

smartDATA

CAD data

3D Download 243-804	URL	Download
---------------------	-----	----------

Subject to changes.